



# Catalogue 2019-2020 Chillers and air side equipment



**NEW**

**New Climate Chamber and Witness Testing**

High performance and reliability for comfort and process applications

The background of the slide is a photograph of a blue sky with white, fluffy clouds. In the lower right corner, the top of a building is visible, featuring a large blue and white Daikin logo on its facade. The logo is partially obscured by a semi-transparent blue overlay that contains the text.

Our promise...

... is to ensure that customers can depend on Daikin for the ultimate in comfort, so that they are free to focus on their own working and home lives.

We promise to dedicate ourselves to technological excellence, a design focus and the highest quality standards so that our customers can trust and rely on the comfort we deliver.

Our promise to the planet is absolute. Our products are at the forefront of low energy-usage and we will innovate to further reduce the environmental impact of HVAC-R (Heating, Ventilation, Air conditioning, Refrigeration) solutions. We lead where others follow.

We will continue our global leadership in HVAC-R solutions as our specialist expertise in all market sectors combined with 90 years' experience enable us to deliver added value in long-lasting relationships based on trust, respect and credibility.

We promise to continue our forward-thinking ethos, treating challenges as opportunities to produce ever-better solutions. We will drive innovation and go the extra distance for our customers and our company.

We will be smart and ready to do things differently.

We will deliver on these core values of our brand and enjoy sustainable success with continued growth.

# Table of content

<b>Daikin, your partner of choice</b>	<b>4</b>
Tools and platforms	5
The best partner for your green project	6
Seasonal efficiency	7
Reliability and Efficiency	8
<b>Daikin chillers, the best choice</b>	<b>11</b>
<b>Why choose Daikin R-32 models?</b>	<b>14</b>
<b>Witness testing</b>	<b>17</b>
<b>Why Maintenance?</b>	<b>22</b>
<b>Daikin Rental Service – Chiller</b>	<b>24</b>
<b>Product overview</b>	<b>28</b>
<b>Air cooled Chillers</b>	<b>33</b>
Air cooled chillers (Cooling only)	34
Air cooled chillers (Heat pump)	78
<b>Water cooled chillers</b>	<b>103</b>
Cooling & Heating only	104
Centrifugal chillers	120
<b>Condenserless chillers</b>	<b>134</b>
<b>Fan coil units</b>	<b>143</b>
<b>Air handling units</b>	<b>173</b>
<b>Control systems</b>	<b>188</b>

## Daikin world

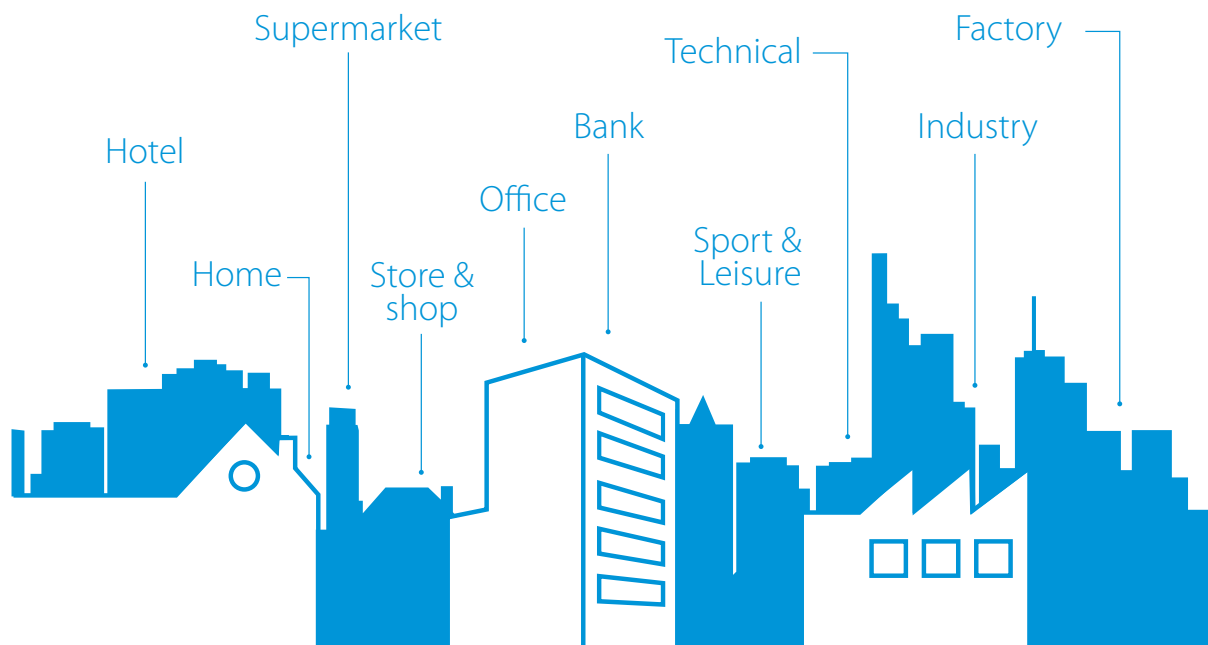



Forged under severe conditions around the world, Daikin chillers, fan coil units & air handling units provide high quality, operation efficiency and energy savings. Various applications are possible including air conditioning applications, industry-type process cooling and heating, and large-scale district cooling and heating.

## A partner of choice

Daikin is Europe's leading manufacturer and global n°1 of highly energy-efficient heating, cooling, ventilation and refrigeration solutions for residential, commercial and industrial applications. Daikin is a leader in using technologies that help preserve the environment, such as those that conserve energy and deliver high reliability to its customers. Daikin's flexible applied systems deliver high efficiency for commercial, institutional and industrial buildings.

## The comfort of reliability

Nobody is really looking for complexity in business. Because complexity often leads to mistakes, delays or losses. Unfortunately, the world we are all doing business in, is sometimes quite complex. When looking for further business development, we all expand our national and international operations. And that doesn't make things easy.

As a small scale business or multinational company, you deserve the best partners. Partners that can take away the headaches and make you feel comfortable again. With Daikin, you have found such a partner. Because Daikin would like things to be easy ... for you.

## Daikin quality

Daikin's much envied quality quite simply stems from the close attention paid to design, production and testing as well as aftersales support. To this end, every component is carefully selected and rigorously tested to verify its contribution to product quality and reliability.

## Staff who understands you

Daikin and its staff of devoted engineers, consultants and analysts are ready to assist you on a daily basis in setting up nationwide or international agreements, providing advice on equipment selection and monitoring regulations. Our goal is to help you carry out your plans with confidence, using custom-designed systems that meet your needs (for comfort, performance levels, support and service).

## Daikin Applied Development Center

Opened in May 2009, the Daikin Applied Development Center is the world's most advanced facility for heating, ventilation and air conditioning (HVAC) research and development. The purpose of the center is to develop and test advanced chiller, compressor and other HVAC technologies to reduce energy consumption and, ultimately the carbon footprint of the buildings where they will be used.

# Tools and platforms

Have a question, looking for specific software applications, need detailed product information or looking for any other marketing tools? This overview gives you an idea of what we can offer.

## Selection software

Daikin Europe offers you a variety of building modelling, selection, simulation and quotation software tools to support your sales.

### Web-based chiller selection software

A user-friendly interface allows users to quickly create new projects, open and change existing projects or simply do a quick selection.

Technical selection reports can be printed or downloaded in several formats. To make life easier, the tool is accessible everywhere, via any device. No matter where you are, projects can be consulted.

Create now a new account on:  
> <http://tools.daikinapplied.eu/>



## Online support

### Business portal

- Experience our new extranet that thinks with you
- > Find information in seconds via a powerful search
  - > Customize the options so you see only info relevant for you
  - > Access via mobile or desktop via **my.daikin.eu**

### Daikin on Site



A new remote monitoring and control for chillers and air handling units has been developed by Daikin to give peace of mind to the end-customer.

Using this new tool results in optimum use and costs over the system's entire lifetime:

- > enhanced control and measuring
- > monitors the system
- > reduces risks at the earliest possible moment
- > keeps the system running as it was intended to

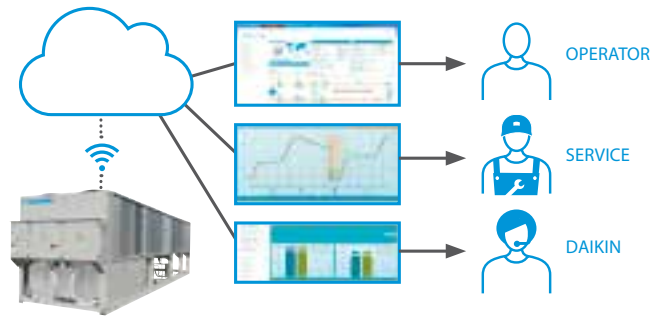

### Web-based Air handling unit selection software

#### ASTRA Web

- > Quick AHU selection that will save you precious time, drastically reducing selection time through the new software interface.
- > Very competitive solution available within the Wizard thanks to pre-uploaded parameters.
- > High selection quality, thanks to the intelligence embedded within the software core.

### Web-based Fan Coil unit selection software



- > Fan coil unit selection is now easily possible with a new and user friendly integrated interface.



**BREEAM<sup>®</sup>**

# Daikin, the best partner for your green project

From 2015 onwards the majority of new building projects in Europe are expected to be green.

93% percent of developers & investors consider green certification important

BREEAM and LEED green building programmes are the two most important sustainable building certificates in Europe, covering more than 75% of the total sustainable-building certificate market.

## Property developers are setting high standards

- › Aiming for a BREEAM Excellent or LEED Gold target is no longer rare
- › The real challenge? Achieving these targets while staying within budget

## HVAC-R systems play an important role

- › Within the total green assessment & investment cost
- › They require the alignment of many different parties

BREEAM is a registered trademark of BRE (the Building Research Establishment Ltd. Community Trade Mark E5778551). The BREEAM marks, logos and symbols are the Copyright of BRE and are reproduced by permission.

It is essential to choose an HVAC-R partner with the knowledge and portfolio to achieve your BREEAM or LEED objectives, and other green needs.

Daikin has successfully participated in many green and sustainable projects. Helping builders achieve BREEAM Excellent, LEED Gold, NZEB and similar certificates has become one of our specialities.



**We have a team of BREEAM accredited professionals (APs) at your service!**

- › Over 17 APs across Europe
- › Assisting you to achieve your BREEAM certificate



**You get maximum support in scoring BREEAM credits & LEED points:**

- › Daikin Total HVAC-R Solutions
- › High seasonal efficiency technologies
- › Smart energy management with intelligent network
- › Boost your end score with innovative products & technologies

## Maximise your BREEAM and LEED green building programme score with Daikin solutions

### › **Manage up to 70% of your energy consumption with the Daikin Total Solution**

### › **Top seasonal efficiency**

Both BREEAM and LEED green building programmes put the strongest focus on energy efficiency. This is exactly why it's so important to choose Daikin.

### › **Smart air conditioning management with Intelligent Network**

To drastically reduce your energy consumption and CO<sub>2</sub> emissions it's not enough to simply make your equipment more efficient.

# Seasonal efficiency,

## Smart use of energy

### Challenging 20-20-20 environmental targets

The European Commission has set challenging targets for improving energy efficiency in the EU. These so-called 20-20-20 targets aim at a 20% reduction in CO<sub>2</sub> emissions, 20% share of renewable energy and a 20% reduction in the use of primary energy, all by the year 2020. To realise these objectives, Europe issued the Eco-Design Directive [2009/125/EC]. This sets minimum efficiency requirements for energy related products.

#### European action plan 20-20-20

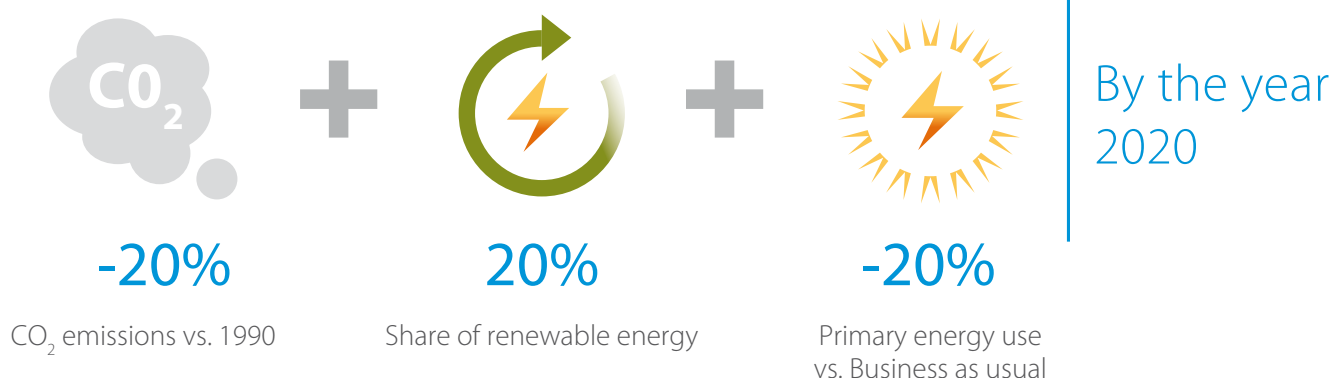

### Applied systems: products in scope

Since 26 September 2015, heat generators for space heating (LOT 1) also need to comply to these 20-20-20 targets. For the applied systems market it means that all heat pumps below 400 kW need to comply to minimum efficiency requirements. Heat pumps below 70 kW must be marked with a product energy label.

### Our service

Daikin helps its partners to meet their obligations regarding the Ecodesign Directive and energy labelling. Labels, product and technical fiches for each individual product are available as downloads at any time from the Energy Label Generator at [https://www.daikin.eu/en\\_us/about/daikin-innovations/seasonal-efficiency.html](https://www.daikin.eu/en_us/about/daikin-innovations/seasonal-efficiency.html).

# Day-to-day reliability and efficiency

## Inhouse development and manufacturing of compressors

Unlike many other air conditioning manufacturers, Daikin manufactures its own compressors. This is important because the compressor is the very heart of the air conditioning system, increasing the pressure and temperature of the refrigerant vapour, effectively concentrating the heat as it passes around the system. Daikin has always been at the forefront of developing compressor technology and now offers a comprehensive range of swing, scroll, screw and centrifugal compressors. As a result, inverter compressor control is applied throughout our product range, delivering enhanced comfort and system efficiency.



### Swing compressor

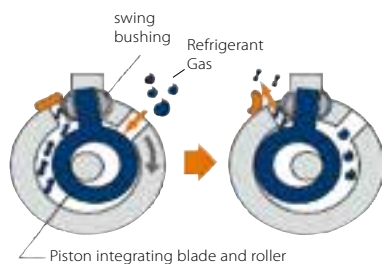

The mini chiller series EWAQ005-007ADVP & EWYQ005-007ADVP are equipped with a swing inverter compressor. This innovative design by Daikin has fewer moving parts allowing a smoother, more reliable operation with low vibration and low noise levels. The high-efficiency motor reduces energy consumption, resulting in energy cost savings.



### Scroll compressor for controlled capacity

Being compact, the Daikin scroll compressor is used with R-407C and R-410A to provide constant reliability and high efficiency throughout its service life. Designed for small and medium capacities, the scroll compressors are used with air cooled and water cooled chillers.

#### Characteristics:

- › Compact, simple yet robust design
- › Absence of valves and oscillating connecting mechanisms providing maximum reliability
- › Constant compression guaranteeing low energy consumption
- › Increased compression efficiency thanks to the absence of volumetric re-expansion
- › Low sound level
- › Low starting current

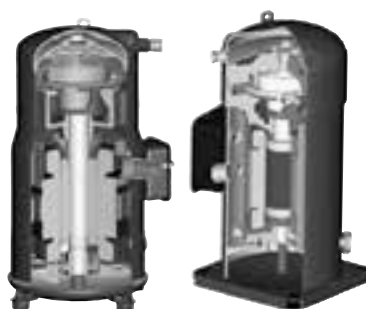

### Innovative frictionless centrifugal compressor

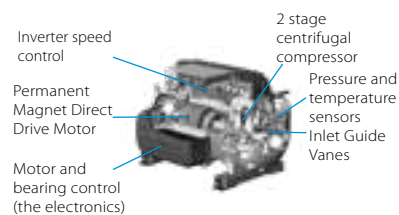

The innovative frictionless centrifugal compressor has an integrated VFD, as well as magnetic bearings, and delivers high levels of unit efficiency and reliability. The compressor's only moving part - the rotor shaft and impellers - are powered by the permanent magnetic direct-drive motor and kept levitated by a digitally controlled magnetic bearing system. This reduction in moving parts significantly increases unit reliability and reduces maintenance costs. As the condensing temperature and/or cooling load reduces, the speed of rotation reduces and movable inlet guide vanes, activated by the step motor, redirect gas flow into the first stage impeller once the compressor has reached its minimum speed. This delivers increased efficiency and cost savings during part-load operations.



Whatever the requirements of the customer - large systems requiring constant capacity or small systems for flexibility - Daikin always provides a reliable and efficient solution.



### The single-screw stepless compressor for high capacity

At the heart of the larger Daikin chillers is a semi hermetic single screw compressor, designed, tested and manufactured in Daikin's own factories, in order to meet the highest capacity, performance and maintenance specifications. This compressor has been especially developed for operation with R-410A or R-134a refrigerants, guaranteeing unequalled reliability and many years of efficient operation. The bearing life is 100,000hrs with inspection and maintenance intervals every 40,000hrs.

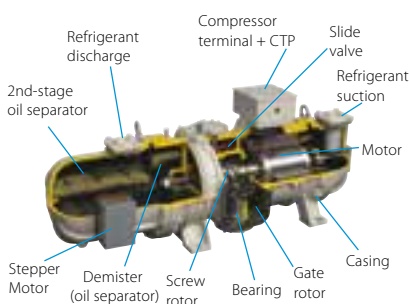

#### Characteristics:

- › Optimal performance through stepless capacity control chilled water temperatures. The unit capacity is infinitely variable from 30 - 100% on single circuit units and 15 -100 % on dual circuit units.
- › Compact, simple yet robust construction.
- › Using a main single screw and two gate rotors, axial and radial forces are balanced, thanks to the symmetrical compression guaranteeing low bearing loads.
- › Gate rotors made of polymer material result in closer tolerances with the main screw and reduced friction greatly improves compressor efficiency and lifetime.
- › No oil pump necessary - lubrication based on the differential pressure principle.
- › Easy access to both compressor and safety devices.
- › Star-Delta starter with low starting current as standard.



### Screw compressor with integrated inverter (EWAD-TZB)

#### Characteristics:

- › Compressor and inverter fully designed by Daikin
- › Inverter integral to the compressor body
- › Inverter refrigerant cooled
- › VVR = Variable Volume Ration for optimized efficiency
- › Enlarged discharge port and suction side for reduced refrigerant pressure drop
- › New optimized compressor motors

#### Main benefits:

- › Better ESEER & EER values
- › 30% more compact than single-screw compressor
- › Rapid payback time
- › Silent operations
- › Optimal comfort levels

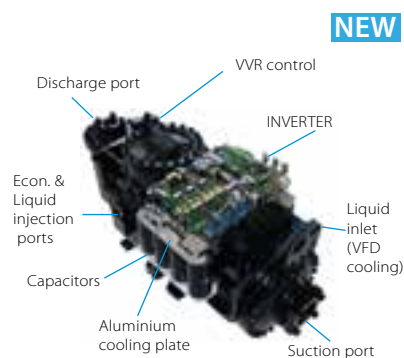

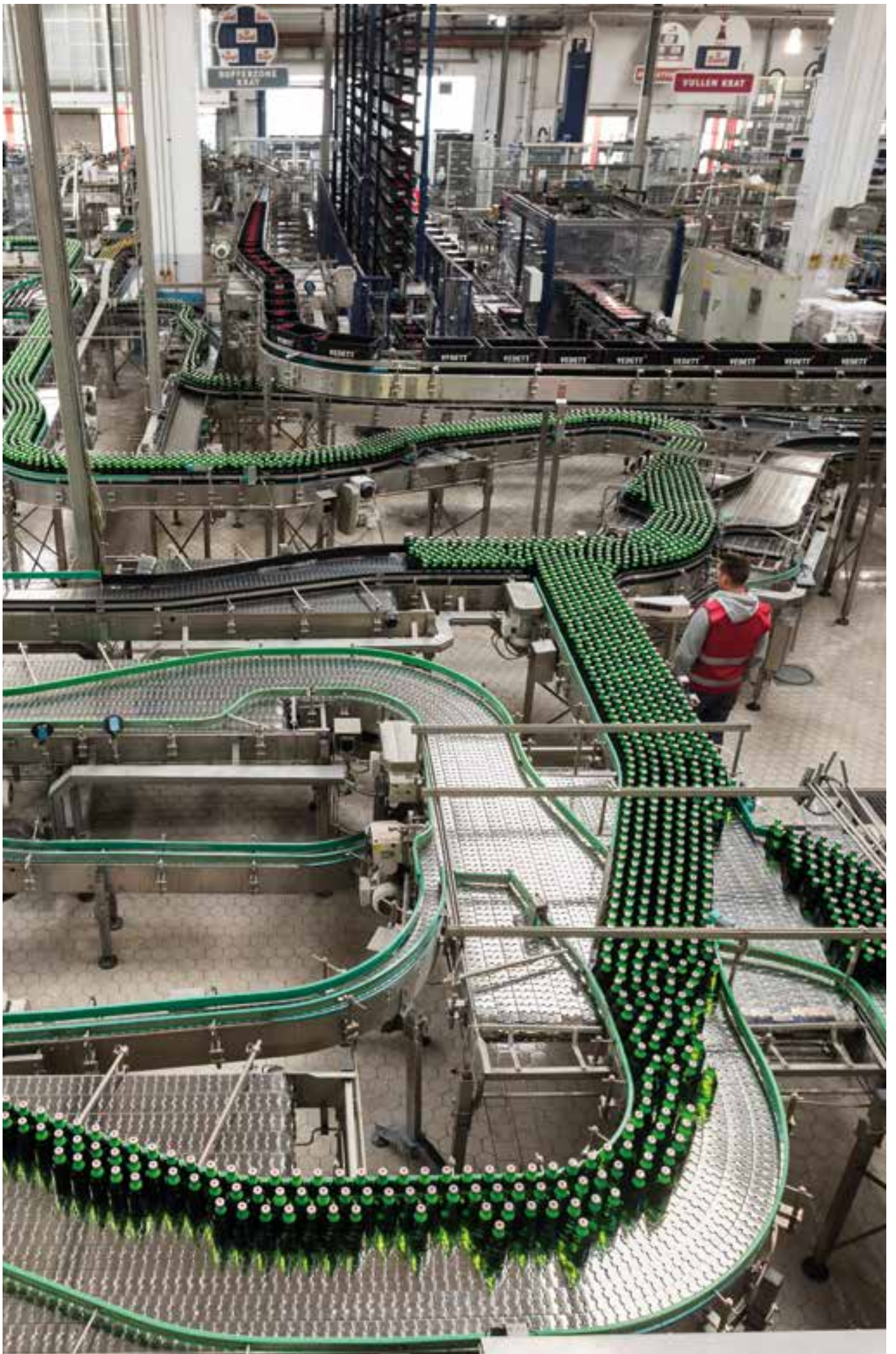



Daikin chillers

# Why choose

## Daikin chillers

### The widest and most flexible chiller portfolio

- › From the smallest chiller for residential use to the largest chiller for district cooling
- › Tailor made solutions based on the most advanced technologies

### Worldwide experience in chiller design and manufacturing

- › World's most advanced facilities for air conditioning research and development: the Applied Development Center in Minneapolis, Minnesota
- › Inhouse development and manufacturing of chiller main components (compressors, fans, condenser coils, software, etc...)
- › Chillers produced in European factories, in Milan and Ostend

### The highest efficiency for every installation

- › The lowest total cost of ownership and fast payback time

### Quality and reliability

- › Daikin's integrated zero defect policy ensures quality of components and finished products
- › Each Daikin chiller is factory run-tested and subjected to quality audit before shipment

## Web-based Chiller selection software

A user-friendly interface allows users to quickly create new projects, open and change existing projects or simply do a quick selection.

Technical selection reports can be printed or downloaded in several formats.

To make life easier, the tool is accessible everywhere, via any device. No matter where you are, projects can be consulted.

Create now a new account on:  
<http://tools.daikinapplied.eu/>

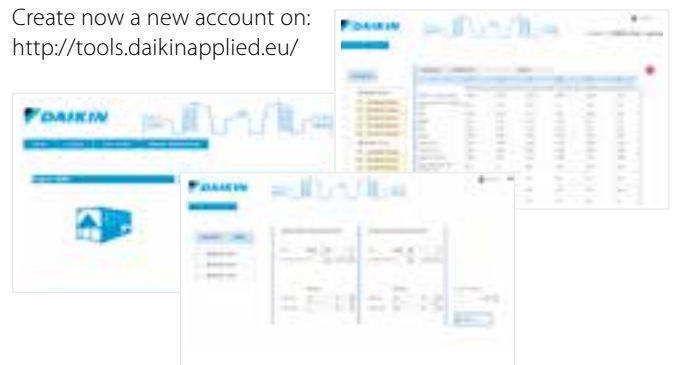

## Benefits for the installer

- › Plug & play solutions
- › Maximum serviceability
- › Ideal solutions for retrofit projects

## Benefits for the consultant

- › Energy efficient solutions without compromising on reliability and performance
- › Latest technology embedded in all our products

## Benefits for the end user

- › Remarkable savings on running costs
- › "Green" solutions to preserve the environment
- › Eurovent and AHRI certification

# Lower your running costs

## with our energy saving options



### Inverter technology

Traditional electric motors run at full load even when not needed (in chiller part load operations), resulting in energy waste.

Since in a building most of the energy consumption comes from HVAC systems and the cooling/heating load varies during the year depending on the application, energy saving becomes vital, especially with the current soaring price of energy and global warming concerns.

VFD (Variable Frequency Drive) allows the use of only the power necessary to perfectly match the real load, a highly efficient and green solution for HVAC applications (compressors, fans and pumps).

During most of the chiller operating time, the cooling capacity required in a building is lower than the peak load conditions, according to the building load profile.

The higher load variations during the year, the more vital is operating efficiency of the machine.

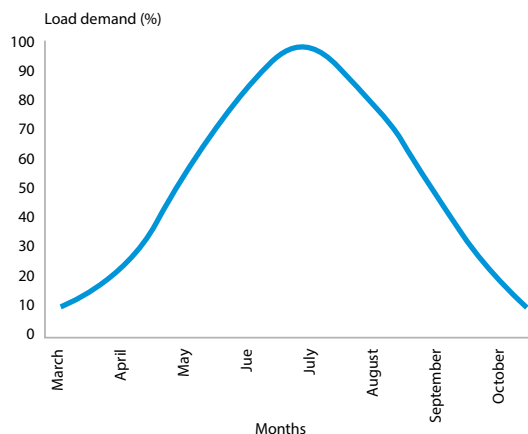

### What are your benefits when choosing an inverter chiller ?

- › Energy efficient: displacement power factor always > 0.95  
Usually the power factor of a motor progressively worsens with the decrease of the power output. However, thanks to the inverter, there is no need for additional power factor correction capacitors as the power factor is always > 0.95 and there are no power surges so costs are constrained.
- › Quick start-up: start-up time reduced by 1/3  
The ability to vary the output power in direct relation to the cooling requirements of the system by allowing compressor boosts gives the inverter chiller a reduced start-up-to-operating-capacity, making it possible to achieve comfort conditions in 1/3 less time than with conventional systems.
- › Less frequent start/stop cycles and low starting current  
The inverter technology ensures fewer start/stop cycles as well as ensuring that the start-up current is always lower than the current absorbed maximum operating conditions (FLA). This generates obvious cost savings.
- › Seasonal quietness: reduced sound levels  
Low sound levels in partial load conditions are achieved by the variation of compressor frequency, thus ensuring minimum sound levels at all times.

All these benefits will lead to a decrease in the overall running costs, resulting in a rapid return on investment.



### Air-to-water heat pump technology

Air-to-air water pumps obtain 75% of their output energy from a renewable source: the ambient air, in summer and winter, even when it is freezing outside; air which is both renewable and inexhaustible.

A heat pump's efficiency is measured in SCOP (Seasonal Coefficient Of Performance) for heating and ESEER (Seasonal Energy Efficiency Ratio) for cooling. Our units deliver maximum energy efficiency and the minimum of operating costs.

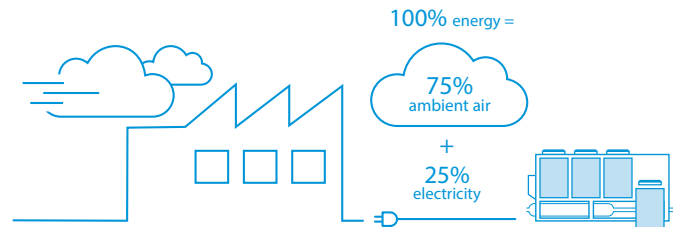

### Heat recovery (option n°01-03)

For those particular applications where heating and cooling may be required at the same time during operation of the chiller (e.g. hotels, manufacturing, hospitals) partial or total heat recovery options are available. The heat recovery technology extracts heat from the cooling process to ensure free or low-cost heating for other facilities in your company.

### Rapid restart (option n°110)

In case of power failure the Daikin chillers can quickly restart and load up to 100 % in a very short time (typically less than 6 minutes versus circa 20 minutes in case of a standard chiller) Rapid restart means lower impact on the customer side especially in critical applications where they cannot afford to lose cooling: e.g. data centers and hospitals



### Free cooling (option n°113)

Free cooling uses cold air from outside to assist in chilling water for applications such as data centers that need cooling during cold season. When the ambient air temperature drops below a set point, all or part of the chilled water bypasses the existing chiller and runs through the free cooling system, thus using less power.

When outside temperatures are +2°C or lower, the chiller compressors are fully shut down and cooling is almost for free. This dramatically reduces the load on the system and cuts energy consumption by up to 75%, as well as prolonging the lifespan of the chiller.



Daikin, world's first company introducing a new generation of air cooled scroll chiller series with refrigerant R-32.

## Why choose Daikin R-32 models?

**Daikin is continuously leading in chiller technology, striving again for innovation with the new generation of air cooled chillers with R-32 refrigerant, expanding its Bluevolution range to larger capacities.**

With the highest efficiency at both partial and full load, installers and building owners can give end users better results all year round comfort – with lower noise levels and higher energy efficiency than ever before.

Thousands of sites around the world have relied on Daikin high efficiency products to reduce their running costs without compromising on climate comfort or performance.

With the new R-32 Scroll-chiller, Daikin has once again improved the chiller performances, increasing the Seasonal efficiency ratio (SEER) by 10% in comparison to the version with R-410A refrigerant.



# Why has Daikin introduced R-32 models?

**A core element of Daikin's corporate philosophy is that the company strives to be a leader in applying environmentally friendly practices, with energy efficiency and refrigerant choice as key factors.**

Daikin, involved in both HVAC and refrigerant business, was the world first company to introduce R-32 in split air conditioners in 2012, and has expanded the range in the past years including commercial air conditioners and heat pumps. As of December 2017, Daikin sold approximately 12 million R-32 units in more than 50 Countries. The global warming potential of R-32 refrigerant is 675, which is only one third compared to commonly used refrigerant R-410. Thanks to the lower flammability classification (R-32 refrigerant falls into category class A2L in ISO817), it can be safely used in many applications including chilled water systems. As a single component refrigerant, R-32 is also easier to recycle and reuse another environmental plus in its favour.

## What is GWP?

Global Warming Potential (GWP) is a number which expresses the potential impact that a particular refrigerant would have on global warming if it were released into the atmosphere. It is a relative value which compares the impact of 1kg of refrigerant to 1kg of CO<sub>2</sub> over a period of 100 years.

Although this impact can be avoided by preventing leaks and ensuring proper end of life recovery, choosing a refrigerant with a lower GWP and minimizing the volume of refrigerant will reduce the risk to the environment if a leak were to occur accidentally.





# Witness testing

## Peace of mind system integration

Each day, the solutions offered by Daikin Applied Europe ensure people the best configuration for their thermic comfort. Our solutions for process cooling and heating are worldwide requested. Any application can be served, resulting in a wide range of products available for our customers. We are industry leaders in air cooled and water cooled chiller technologies. All our efforts result in dedicated solutions tailored to application peculiarities. Our performance in each condition can be shared with customers during witness tests.

During witness testing even the toughest design conditions can be simulated. Customers and consultants can appreciate product performance before its delivery, ensuring “peace of mind” chiller integration in the whole project.

We have specific competencies and state of the art testing facilities to pursue these goals.

### **The new Daikin Applied Europe testing facilities in Cecchina factory (Rome, Italy) include:**

- › A newly built climatic test chamber
- › 3 test stands dedicated to water cooled chillers
- › Customer Lounge, from where testing can be viewed in all comfort



# New Climatic Chamber



The state-of-the-art testing centre follows a rigorous set of procedures to ensure proper operation of Daikin products in any environment. The new testing regime has been independently verified and accredited to EN 14511:2013, ISO 9614:2009 and other major recognised European and American HVACR industry standards. In addition, the climatic chamber has been approved by the Air Conditioning, Heating and Refrigeration Institute (AHRI), with tests on air-cooled units for the Eurovent testing campaign being conducted in this new Daikin facility.

Up to  
**2000 kW**  
in cooling  
at the forefront  
of testing

The range of tests that could be performed in the new chamber is very wide. It can be summarized in:

#### **Eurovent and AHRI conditions at full load and part load**

##### **Customized full load and part load points, including:**

- › High ambient temperature installations: up to +52 °C
  - › Extremely low ambient temperature: down to -15 °C
  - › Negative evaporator leaving water temperature conditions: down to -8 °C with glycol solutions
  - › Heat recovery and heat pump tests
  - › 4-6 pipes units
  - › Free cooling
  - › Acoustic tests
- 
- › Voltage range: 380 – 400 – 440 – 690 V
  - › Frequency range: 50 – 60 Hz

The new climatic chamber enables testing of the entire aircooled chiller range, in any design condition.



**EWYD-4Z Multipurpose units**

4 and 6 pipes layouts can be tested



**NEW R1234ze chiller EWAH-TZ B**

Up to 1060 kW – 20 FANS



**Up to 30 FANS chiller EWAD-T B**

Cooling capacity up to 2000 kW

Each application can be simulated. From comfort cooling conditions (residential / office / commercial buildings / hospitals) to highly customized chillers for industrial process cooling applications (food / pharma / refrigerated warehouses / data centers, etc.). Chillers for rental cooling purposes can be tested in our facility, in different expected operating conditions.

Here are only a few examples of successful witness tests:



**Application: Pharma**

**Unit: EWADC11TZ-XS B2**

Cooling load: 695 kW

Conditions:  
Chilled water in/out: 0/-5 °C  
Ambient temperature: 42°C

Tests performed:  
Full load + 3 part loads  
Testing time: 1 day



**Application: Bank headquarters**

**Unit: EWYD580BZ-SS**

Cooling load: 580 kW  
Heating load: 618 kW

Conditions:  
Chilled water in/out: 12 / 7 °C at 35 °C ambient  
Heated water in/out: 40 / 45 °C at 7 °C ambient

Tests performed:  
Full load in cooling & heating  
50% part load in cooling  
Acoustic test in cooling – full load  
Testing time: 1 day



**Application: Hospital**

**Unit: EWYD6504Z-XR A2**

Cooling load: 756 kW  
Heating load: 751 kW

Conditions:  
Chilled water in/out: 12 / 6 °C at 38°C ambient  
Heated water in/out: 40 / 45 °C at 5 °C ambient

Tests performed:  
Full load in cooling & heating  
Acoustic test in cooling – full load  
Testing time: 1 day

# Water cooled test stands

Our chiller testing facility offers the most advanced testing technology for water cooled units. 3 test stands are available for witness testing purposes, up to 2 – 4 – 11 MW cooling capacity. The largest capacity test stand is also AHRI approved.



Cooling applications can be simulated in many conditions. From small-medium sized comfort cooling conditions (residential / office / commercial buildings) to highly customized chillers for industrial process cooling applications (food / pharma, etc.) and up to large

public buildings and district cooling applications. Chillers for marine applications can be tested in our facility, ensuring complete integration of the chiller in the ship's HVAC system.

Here are only a few examples of successful witness tests:



**Application:** Courthouse

**Unit:** EWWDC21VZ-XS A2

Cooling load: 1736 kW

Conditions:

Chilled water in/out: 10 / 5 °C  
 Condenser water in/out: 40 / 45 °C  
 Power supply: 400 V / 50 Hz

Tests performed:

Full load + 3 part loads  
 Testing time: 1 day



**Application:** Marine – cruise vessel

**Unit:** DWDC

Cooling load: 6000 kW

Conditions:

Chilled water in/out: 12 / 6 °C  
 Condenser water in/out: 32 / 38 °C  
 Power supply: 11000 V / 60 Hz

Tests performed:

Full load + 3 part loads  
 Testing time: 1 day



**Application:** District cooling

**Unit:** WCT

Cooling load: 11 MW

Conditions:

Chilled water in/out: 10 / 5 °C  
 Condenser water in/out: 35 / 39 °C  
 Power supply: 11000 V/50 Hz

Tests performed:

Full load + 3 part loads  
 Testing time: 1 day

**Power supply conditions can be set according to an extensive range:**

Voltage: 380 – 400 – 460 – 690 – 3000 – 3300 – 4160 – 6000 – 6600 – 10000 – 11000 – 13200 – 13800 V  
 Frequency– 60 Hz

# Customer Lounge

We elevate witness testing experience to a higher level. The dedicated lounge rooms ensure remote data log and monitoring from test stands. Product control and open discussion on product and design characteristics can then be fulfilled comfortably.



Product performance can be confirmed from the comfort of your chair. Details can be observed from the webcams all around the unit, ensuring customer expectations and safety. As well, the unit under testing can be directly checked through the glass.

Our customers are free to select what should be displayed on our monitors just by clicking on our tablet

# Why Maintenance?



## Peace of mind

Our Daikin service team strives to develop smart services & solutions to exceed your expectations. Ensuring that your HVAC systems are maintained by Daikin professionals gives you peace of mind!

## Improved Safety

When a system doesn't operate in optimal condition over longer periods of time, it could cause unsafe working conditions or accidents. Regular maintenance ensures the unit operates safely and complies with local regulations and requirements.

## Full Legal Compliance

Knowing that your units are maintained and serviced gives you the assurance all relevant legal requirements (e.g. F-gas regulation) are fulfilled.

**REGULATION (EU) No 517/2014 OF THE EUROPEAN PARLIAMENT AND OF THE COUNCIL of 16 April 2014 on fluorinated greenhouse gases and repealing Regulation (EC) No 842/2006**

## Healthy Air

A properly maintained system will not only keep premises warm or cool, but it will prevent problems with air quality. Clean filters and coils mean better breathing for all users. An unmaintained system is a breeding ground for dirt, mould and bacteria, all of which can cause or worsen respiratory problems for those living or working in the building or house.

## Cost Savings

In the long run, maintenance is always cheaper than ad-hoc service interventions. Preventive maintenance allows you and Daikin to plan ahead and avoid rushed interventions. Our specialists will come prepared, thus avoiding repeated visits and extra interruptions.

Another benefit is the clear and transparent costs which can easily be budgeted, as well as clear and well-founded lifecycle reports which indicate future needs and requirements to be considered well in advance. Over time this reduces the Total Cost of Ownership (TCO) and related operational costs.

## Minimized System Downtime

Scheduled care visits are transparent and easy to plan which gives sufficient time to find suitable dates for visits to avoid impact on production or comfort. A well-maintained system is less likely to fail during high season. Keeping a unit up-to-date on all inspections and maintenance checks means less worry that the unit will break down when it is needed the most.



### Increased System Efficiency

Regular maintenance of a HVAC system ensures that electricity costs and performance are not jeopardized, and that the safety features and the integrity of the system are in line with the latest standards and regulations.

Routine maintenance such as inspections, oil and fluid changes, part replacements and other little fixes can help your system to run much more efficiently. In turn, you will benefit from fuel and energy savings because the units will be running at peak performance.

### Emergency Call-out

In case your system should still break down, all Daikin Care packages include access to a Hotline number for emergency call-out. Preventive and Extended Care also include Emergency Service Hotline access outside of regular office hours.

### Genuine Spare Parts, Tools and Equipment

The spare parts used are all certified by Daikin, which means that the risk of failure and disturbances can be reduced while ensuring that the warranty is valid.

In case opening, overhaul or repair is needed, Daikin as an OEM manufacturer has all the original tools, casts and equipment to ensure the repair is carried out according to factory recommendations and will keep your equipment up and running.

Daikin uses advanced service tools when we care for our systems. These tools are not found on the

open market and they facilitate advanced troubleshooting and reporting to be done to ensure that the unit is optimized and parametrised correctly as well as verifying the integrity of the system.

### Attractive Modernisation Solutions

Daikin also offers attractive modernisation solutions (retrofit or full replacement) for a range of older Applied systems. In the case of retrofit, core parts of the system will be replaced to ensure it can run for many more years. Using Daikin certified retrofit solutions from Daikin or Daikin Certified partners allow you to enjoy the benefits of reduced operating costs, no need to refurbish or reinstall and will include an attractive warranty policy if performed under a care agreement.





## Daikin Rental Services – Chillers

- › Solutions for cooling emergencies
- › Standby cooling for critical applications and processes
- › Cooling supply during planned shutdowns and outages
- › Solutions for cooling load fluctuations & special events





# Why use temporary cooling from Daikin?

Daikin is the largest air conditioning, heating, ventilating and refrigeration (HVACR) company in the world. We have earned a worldwide reputation for providing HVAC systems that can save you money while providing optimal overall system performance and occupant comfort. Our Rental machines are typical high Daikin built quality. Reliability and compact size make Daikin machines an excellent choice for all Rental applications.

## Benefits

### Many reasons to use temporary cooling

Daikin Rental is offering rental chillers and services to meet your temporary cooling needs while reducing CAPEX (capital expenditures) and optimizing your OPEX (operational expenditure). Daikin Rental covers:

#### 1. Solutions for COOLING EMERGENCIES

Whether a natural disaster and/or an equipment failure takes your cooling system down, Daikin temporary cooling can get you up and running again fast!

#### 2. Standby cooling for CRITICAL APPLICATIONS and PROCESSES

A temporary cooling system is sometimes used to back-up manufacturing, and chemical processes, or when a hospital's required system redundancy has been reduced.

#### 3. Cooling supply during PLANNED SHUTDOWNS AND OUTAGES

##### • Planned maintenance on cooling equipment

Daikin temporary cooling is an excellent way to supply cooling during planned equipment maintenance, which elevates the time pressure to get your primary cooling system back on line. This way, the work can be completed correctly the first time, and avoid costly overtime.

##### • Replacement of older equipment

Daikin temporary cooling makes it possible for your facility to maintain full cooling capabilities during retrofit, renovation, or replacement.

#### 4. Solutions for COOLING LOAD FLUCTUATIONS

##### • Load adjustments during facility expansion

During facility expansions there is a need to test equipment and process areas but not sufficient load to keep new or large chillers running. A simple rental solution ensures the correct load and energy efficiency while the expansion new build is being finalized.

##### • Peak load support & seasonality

When the cooling demand of your facility or process exceeds your current system's capacity because of record high temperatures or changes to the cooling requirements, Daikin temporary cooling can be used to increase your cooling output. By eliminating the need to purchase additional cooling equipment which might be only used part of the year, you save on capital expenditures.

#### 5. Special EVENTS

We can support you with creating a comfortable climate for your special events and parties by putting together the right equipment for your specialty cooling requirements. Quick and easy solutions for fairs, trade shows, events in temporary structures, etc.



## Daikin Rental Chiller offering

### Comprehensive packages - for all your needs

We offer a complete package with your rental chiller, which includes everything you need including pumps and other equipment:

- Water and air-cooled chillers at most used capacities ranging from small air-cooled to large water-cooled in the range from 10kW to 10MW
- Flexible water piping connections with quick, easy set-up
- Electrical connections to chillers work with your current power supply conditions including transformers

Whether you have long or short-term cooling needs, we deliver reliable chiller products, applications expertise, and responsive support.

FROM  
**10** kW  
to  
MW

### Services offered

- Assistance in determining rental chiller capacity and power generation requirements
- Typically a chiller is up and running within the same day of a chiller delivered to your site
- Daikin can support with contingency planning, including disaster recovery planning and support to meet your industry compliance requirements
- Our portfolio is supplemented by rental heating, emergency generators, supporting accessories and services
- Please contact your local Daikin affiliate for availability

**Daikin undertakes the delivery, assembly and connections of the plants as well as start-up, if required also in partnership with your own technical staff or technicians.**

### Large stock available

Daikin and partners stock most capacity units. If your requested unit is not available, we will strive to find a suitable solution for you.

**For available units and pricing please contact our local Daikin office and use our Rental Cooling inquiry form.**



# Rental offering for other temporary cooling applications

Daikin can also support for requirements outside of traditional process cooling with chillers / cold water machines. This offering includes:

## REFRIGERATION/ COLD STORAGE



- Cold storage rooms
- Refrigerated containers
- Tempering cold storage rooms
- Modular cold rooms
- Freezer rooms
- Shock freezers / Blast freezers
- Ultra low freezers
- Tempering freezer rooms
- Modular freezer rooms
- Freezer containers
- Ice rinks
- Wineries

## AIRCONDITIONING



- Air-handling units
- Rooftops

## HEATING



- Heatpump
- Heatpump Rooftops

## ACCESSORIES



- Hydraulic
- Air side distribution
- Electrical cables and inverters

## SERVICES



- Installation & Commissioning
- Service & maintenance
- Remote monitoring as an additional service



## Peace of mind



















The Daikin Rental service team delivers reliable rental chiller solutions and peace of mind, no matter how urgent or complicated your situation. For assistance with your temporary cooling needs, please contact your local service representative.

## The ideal rental solutions for your expected and unexpected rental needs.

Discover our rental solution portfolio for any cooling or heating emergency. Stay cool during planned shutdowns, outages, load fluctuations and special events, and add heat to your critical applications and processes.



# Products overview

	Refrigerant type *	Refrigerant circuits	Inverter	Free cooling	Compressor			Water heat exchanger		Efficiency version			Sound version		
					Swing	Scroll	Screw	Plate **	Single pass shell and tube	Standard	High	Premium	Standard	Low	Reduced
<b>Cooling only</b>															
EWAQ~BVP		R-410A	1	●		●			●	BPHE		●			
EWAQ~ACV3/ACW1		R-410A	1	●			●		●	BPHE		●			
EWAQ~CWN/P/H		R-410A	1-2	●			●		●	BPHE		●			
EWAD~CF		R-134a	2		●			●			●		●	●	
EWAQ-G		R-410A	1				●		●	BPHE		●	●		●
EWAD-CZ <small>Models in the range 1200 KW - 1800 kW are available</small>		R-134a	2-3	●				●			●		●	●	●
EWAD-TZ B		R-134a	1-2	●				●	●		●	●	●	●	●
EWAH-TZ B	<b>NEW</b> 	R-1234ze(E)	1-2	●				●	●		●	●	●	●	●
EWAD-T-		R-134a	2					●	●		●	●	●	●	●
EWAT-B	<b>NEW</b> 	R-32	1-2				●		●		●	●	●	●	●
<b>Heat pump</b>															
EWYQ~BVP		R-410A	1	●		●			●	BPHE		●			
EWYQ~ACV3/ACW1		R-410A	1	●			●		●	BPHE		●			
EWYQ~CWN/P/H		R-410A	1-2	●			●		●	BPHE		●			
SEHVX-BW SERHQ-BW1		R-410A	1	●			●		●	BPHE		●			
EWYQ~G-		R-410A	1				●		●	BPHE			●		●
EWYQ~F-		R-410A	1-2				●		●			●		●	●
EWYD~BZ		R-134a	2-3	●				●			●		●	●	
<b>Condensing unit</b>															
ERAD~E-		R-134a	1					●			●		●	●	
<b>Multipurpose unit</b>															
EWYD-4Z		R-134a	2	●				●		●		●		●	●

















\* (GWP) : R-410A (2.087,5), R-134a (1.430), R-407C (1.773,9), R-32(675), R1234ze(7)- \*\* BPHE: Brazed plate heat exchanger

# Air cooled chillers, condensing units and Multipurpose units

Cooling capacity (kW)  
Heating capacity (kW)

	0	17,5	200	500	1.000	2.000
	4~8,23					
		8,6~17,0				
			16,8~63,2			
				602~1.555		
		69~154				
					1.166~1.795	
			169~1.104			
			171~1.063			
				291~2.148		
		76,3~701				
0	4~8,23					
	4,1~8,44					
		8,6~17,0				
		9,9~14,8				
		16,8~63,3				
		16,6~62,9				
		21,2~63,3				
		20,8~62,7				
			75,2~165			
			82,2~170			
			158~624			
			173~674			
			247~580			
			271~618			
0						
			116~488			
0						
				400~800		
				400~800		

# Products overview

	Refrigerant Type *	Refrigerant circuits	Inverter	Compressor			Water heat exchanger			Efficiency version			Sound version
				Scroll	Screw	Centrifugal	Plate **	Single pass shell and tube	Shell and tube	Standard	High	Premium	Standard
<b>Water cooled chillers (Cooling only &amp; Heating only)</b>													
EWVQ-KBW1N 	R-410a	1-2		●			●			●			●
EWHQ~G- 	R-410A	1		●			●			●			●
EWVQ~G- 	R-410A	1		●			●			●			●
EWVQ~L- 	R-410A	2		●			●			●			●
EWWD~J- 	R-134a	1			●		●			●			●
<b>Water cooled chillers (Cooling only)</b>													
EWWD-VZ 	R-134a	1	●		●				● Flooded	●	●	●	●
EWVH-VZ <b>NEW</b> 	R-1234ze(E)	1	●		●				● Flooded	●	●	●	●
<b>Condenserless chillers</b>													
EWLQ-KBW1N 	R-410a	1-2		●			● BPHE			●			●
EWLQ~G- 	R-410A	1		●			●			●			●
EWLQ~L- 	R-410A	2		●			●			●			●
EWLD~J- 	R-134a	1			●		●			●			●
EWLD~I- 	R-134a	1-2-3			●			●		●			●
<b>Water cooled centrifugal chillers</b>													
EWWD-DZ <b>NEW</b> 	R-134a	1				●			●		●		●
EWVH-DZ <b>NEW</b> 	R-1234ze(E)	1				●			●		●		●
DWSC DWDC 	R-134a	1	optional			●		● Flooded			●		●
6,000 RT CENTRIFUGAL 	R-134a	2 per chiller				●		● Flooded			●		●

\* (GWP) : R-410A (2.087,5), R-134a (1.430), R-407C (1.773,9), R-32(675), R1234ze(7)- \*\* BPHE: Brazed plate heat exchanger

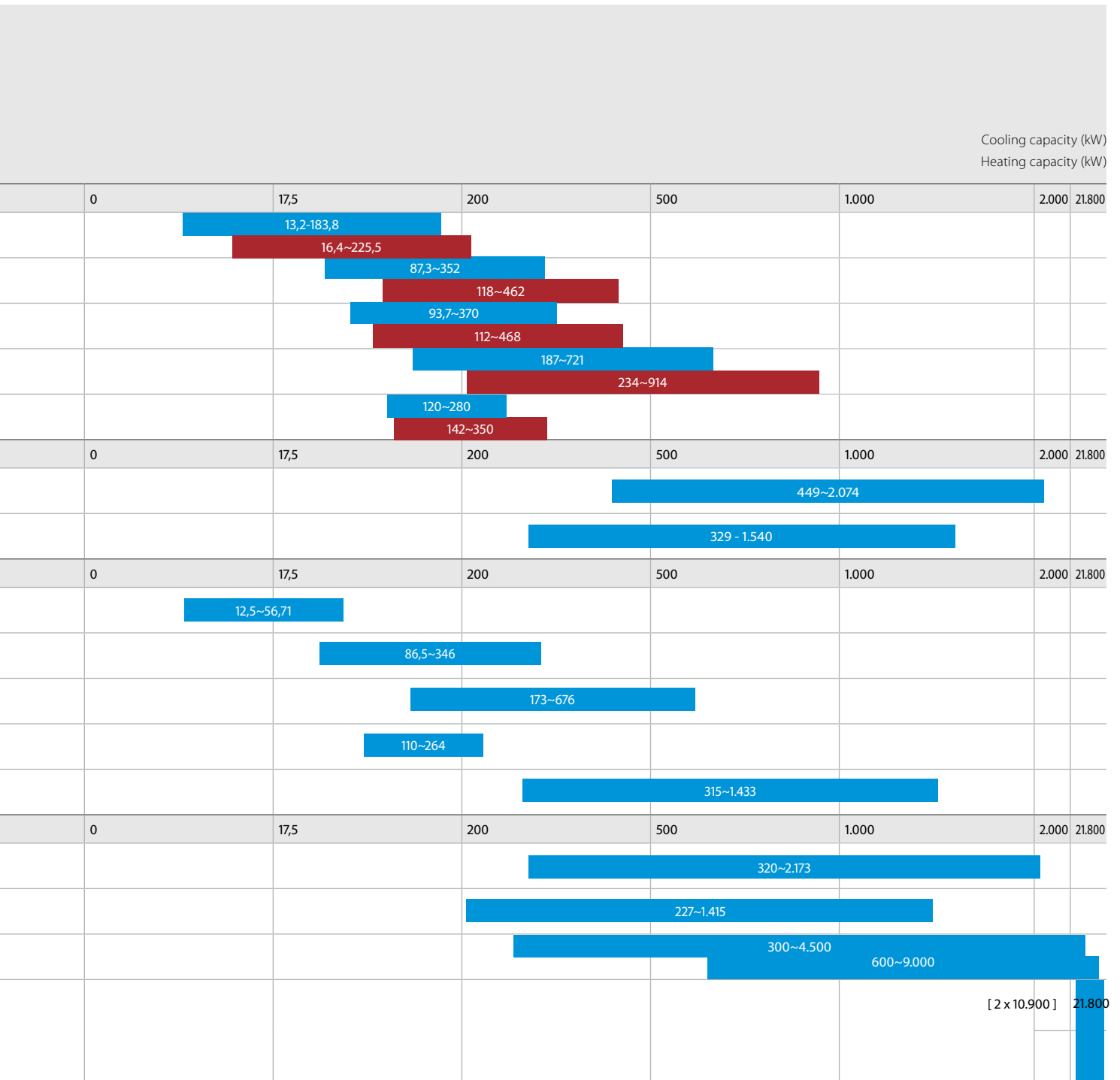



## Why choose a Daikin air cooled chiller?

Daikin air cooled chillers are designed for small to large cooling and heating capacities. A wide range of chillers are available to match every building's air conditioning and process cooling needs. Air cooled chillers are available in different versions:

### Mini chillers

Daikin mini chillers are equipped with an inverter swing or scroll compressor allowing a smooth, more reliable and energy-efficient operation with low noise levels and leader-of-class ESEER. Ideal for residential or light commercial applications.

### Air cooled scroll chillers

Daikin scroll chillers are designed for small and medium cooling and heating capacities. A wide range to match every building's air conditioning and process cooling needs.

### Air cooled screw chillers

Manufactured for large capacities, Daikin screw chillers deliver unparalleled reliability and efficiency, both for comfort and process cooling. Equipped with an inverter they provide high efficiency at part load.

### Wide range of products

Thanks to an extensive product line-up for medium-to large-scale facilities, you can select your optimum model.

### Application versatility

Daikin delivers solutions to a wide range for process and comfort climate applications, for all conditions and both cooling or heating requirements.

### Energy and cost savings

Utilizing the latest technology, Daikin has achieved industry-leading efficiency and energy-saving operation for outstanding cost saving performance.

### Options flexibility

Multiple unique options are available for customizing the chiller to your specific building's needs.



# Table of content

## Air cooled

### Air cooled chillers (Cooling only)

#### **R-410A**

EWAQ-BVP	34
EWAQ-ACV3/ACW1	35
EWAQ-CWN/CWP	36
EWAQ-G-SS	38
EWAQ-G-SR	39
EWAQ-G-XS	40
EWAQ-G-XR	41

#### **R-134a**

EWAD-CZXS/XL	42
EWAD-CZXR	43
EWAD-CFXS/XL	44
EWAD-CFXR	45
EWAD-TZSSB/SLB	50
EWAD-TZSRB	51
EWAD-TZXS/XLB	52
EWAD-TZXRB	53
EWAD-TZPSB/PLB	54
EWAD-TZPRB	55
EWAD-T-SSB/SLB	62
EWAD-T-SRB	63
EWAD-T-XSB/XLB	64
EWAD-T-XRB	65

#### **R-1234ze(E)**

<b>NEW</b> EWAH-TZSSB/SLB	56
EWAH-TZSRB	57
EWAH-TZXS/XLB	58
EWAH-TZXRB	59
EWAH-TZPSB/PLB	60
EWAH-TZPRB	61

#### **R-32**

<b>NEW</b> EWAT-B-SS/SL	72
EWAT-B-SR	73
EWAT-B-XS/XL	74
EWAT-B-XR	75

### Air cooled chillers (Heat pump)

#### **R-410A**

EWYQ-BVP	78
EWYQ-ACV3/ACW1	79
EWYQ-CWN/CWP	80
SEHVX-BW + SERHQ-BW1	81
EWYQ-G-XS	82
EWYQ-G-XR	83
EWYQ-F-XS/XL	84
EWYQ-F-XR	85

#### **R-134a**

EWYD-BZSS	86
EWYD-BZSL	87
EWYD-4ZXS	89
EWYD-4ZXL	90
EWYD-4ZXR	91

# Air cooled mini inverter chiller

- › Top product in terms of energy efficiency and operation range
- › All capacities available in 2 versions: standard version and version with OP10 option (no freeze up of water when not in operation thanks to the water piping heater tape)
- › Easy, 'plug and play' installation
- › Amongst the most quiet units in the market (63dBA - sound power)
- › Single phase power supply and low starting currents make the unit ideal for residential applications
- › Weight reduced with 20% compared with the previous models.
- › Built-in Hydraulic kit: no buffer tank required, standard inverter driven pump, main flow sensor and switch included.
- › Standard wired remote control enables setting of different set points (cooling, heating, water leaving temperature) or based on outdoor conditions (weather dependent control). It has an alarm history, night time noise reduction function and is language based.



› More information  
about EWAQ-BVP

Cooling Only				EWAQ-BVP	004	005	006	008
Space cooling	A Condition 35°C	Pdc	kW	4,00	4,93	5,88	7,95	
	ηs,c		%	172	173	174	178	
SEER				4,38	4,39	4,42	4,53	
Cooling capacity	Nom.		kW	4,00 (1) / 4,01 (2)	4,93 (1) / 5,07 (2)	5,88 (1) / 6,07 (2)	7,95 (1) / 8,23 (2)	
Power input	Cooling	Nom.	kW	1,27 (1) / 0,840 (2)	1,61 (1) / 1,12 (2)	1,87 (1) / 1,13 (2)	2,57 (1) / 1,65 (2)	
Capacity control	Method			Variable (inverter)				
EER				3,14 (1) / 4,80 (2)	3,06 (1) / 4,51 (2)	3,15 (1) / 5,35 (2)	3,10 (1) / 4,99 (2)	
Dimensions	Unit	Height	mm	735				
		Width	mm	1,090				
		Depth	mm	350				
Weight	Unit		kg	83				
Water heat exchanger	Type			Braze plate				
	Water volume		l	1		2		
Air heat exchanger	Type			Cross fin coil/Hi-X tubes and chromate coated waffle louvre fins		Cross fin coil/Hi-X tubes and PE coated waffle louvre fins		
Compressor	Type			Hermetically sealed swing compressor				
	Quantity			1				
Fan	Type			Propeller fan				
	Quantity			1				
Sound power level	Air flow rate	Cooling	Nom.	m <sup>3</sup> /min	53		72 (1)	
	Cooling	Nom.		dB(A)	63 (1)	64 (1)	69 (1)	
Sound pressure level	Cooling	Nom.		dB(A)	48	49	52	
	Operation range	Air side	Cooling	Min.~Max.	10~43		10~46	
Refrigerant	Water side	Cooling	Min.~Max.	°CDB	5~22			
	Type/GWP				R-410A/2.088		R-410A/2.087,5	
Refrigerant charge	Control				Electronic expansion valve			
	Circuits	Quantity			1			
Water circuit	Per circuit			kg	2,10		2,70	
	Per circuit			TCO <sub>Eq</sub>	4,4		5,6	
Unit	Piping connections diameter			inch	1" MBSP			
	Starting current	Max		A	15,7		19,9	
Power supply	Running current	Max		A	15,7		19,9	
	Phase/Frequency/Voltage			Hz/V	1N~/50/230			

(1)Cooling: entering evaporator water temp. 12°C; leaving evaporator water temp. 7°C; ambient air temp. 35°C | (2)Cooling: entering evaporator water temp. 23°C; leaving evaporator water temp. 18°C

# Air cooled mini inverter chiller

- › Inverter technology to ensure low sound values and leader-of-class ESEER
- › Wide operating range
- › Built-in hydronic module: no buffer tank required and a standard pump and main switch are included
- › Easy 'plug and play' installation
- › Single phase power supply for residential applications, three phase power supply model available for light commercial applications



› More information about EWAQ-ACW1



› More information about EWAQ-ACV3



Cooling Only				EWAQ	009ACV3	010ACV3	011ACV3	009ACW1	011ACW1	013ACW1
Space cooling	A Condition 35°C	Pdc	kW	8,49	9,89	11,2	8,75	11,0	13,2	
	ηs,c		%	162	169	171	155	163		
SEER				4,13	4,29	4,35	3,94	4,16	4,15	
Cooling capacity	Nom.		kW	12,2 (1) / 8,60 (2)	13,6 (1) / 9,60 (2)	15,7 (1) / 11,1 (2)	12,9 (1) / 9,10 (2)	15,7 (1) / 11,1 (2)	17,0 (1) / 13,3 (2)	
Power input	Cooling	Nom.	kW	2,85 (1) / 2,83 (2)	3,41 (1) / 3,28 (2)	4,13 (1) / 3,90 (2)	3,08 (1) / 3,05 (2)	4,13 (1) / 3,90 (2)	5,52 (1) / 5,18 (2)	
Capacity control	Method			Variable (inverter)						
EER				4,27 (1) / 3,05 (2)	4,00 (1) / 2,93 (2)	3,79 (1) / 2,85 (2)	4,19 (1) / 2,99 (2)	3,79 (1) / 2,85 (2)	3,08 (1) / 2,57 (2)	
Dimensions	Unit	Height	mm	1.435						
		Width	mm	1.420						
		Depth	mm	382						
Weight	Unit		kg	168						
Water heat exchanger	Type			Braze plate						
	Water volume		l	1,01						
Air heat exchanger	Type			Hi-XSS						
Compressor	Type			Hermetically sealed scroll compressor						
	Quantity			1						
Fan	Type			Propeller fan						
	Quantity			2						
Air flow rate	Cooling	Nom.	m³/min	96,0	100	97,0	96,0	100		
Sound power level	Cooling	Nom.	dBA	64						
Sound pressure level	Cooling	Nom.	dBA	51						
Operation range	Air side	Cooling	Min.~Max.	°CDB 10~46						
	Water side	Cooling	Min.~Max.	°CDB 5~20						
Refrigerant	Type/GWP			R-410A/2.087,5						
	Control			Electronic expansion valve						
Refrigerant charge	Circuits	Quantity		1						
		Per circuit	kg	2,95						
Water circuit	Piping connections diameter		TCO <sub>Eq</sub>	6,16						
			inch	G 5/4" (female)						
Power supply	Piping		inch	5/4"						
		Phase/Frequency/Voltage	Hz/V	1~/50/230				3N~/50/400		

(1)Underfloor program: cooling Ta 35°C - LWE 18°C (Dt: 5°C) | (2)Fan coil program: cooling Ta 35°C - LWE 7°C (Dt: 5°C)

# Air cooled scroll inverter chiller

- › Inverter chiller
- › High part load efficiency for low running cost
- › Minimal starting currents
- › No buffertank required for standard applications
- › Daikin scroll compressor
- › Wide operation range
- › Integrated hydronic module on request



› More information about EWAQ-CWN



› More information about EWAQ-CWP



Cooling Only				EWAQ-CWN/CWP	016	021	025	032	040	050	064
Space cooling	A Condition 35°C	Pdc	kW	16,8(1)/17,0(2)	21,0(1)/21,2(2)	25,3(1)/25,5(2)	31,6(1)/31,8(2)	42,1(1)/42,3(2)	50,5(1)/50,7(2)	63,2(1)/63,4(2)	
	ηs,c		%	168(1)/184(2)	163(1)/178(2)	165(1)/180(2)	154(1)/163(2)	164(1)/168(2)	165(1)/172(2)	154(1)/161(2)	
Cooling capacity	Nom.		kW	16,8(1)/17,0(2)	21,0(1)/21,2(2)	25,3(1)/25,5(2)	31,6(1)/31,8(2)	42,1(1)/42,3(2)	50,5(1)/50,7(2)	63,2(1)/63,3(2)	
Power input	Cooling	Nom.	kW	5,93(1)/5,81(2)	7,61(1)/7,47(2)	9,60(1)/9,45(2)	12,9(1)/12,7(2)	15,1	19,2(1)/19,0(2)	25,7(1)/25,5(2)	
Capacity control	Method			Inverter controlled							
	Minimum capacity		%	25							
EER				2,84(1)/2,93(2)	2,77(1)/2,84(2)	2,63(1)/2,70(2)	2,45(1)/2,50(2)	2,79(1)/2,80(2)	2,63(1)/2,67(2)	2,46(1)/2,48(2)	
Dimensions	Unit	Height	mm	1.684							
		Width	mm	1.370		1.680		2.360		2.980	
		Depth	mm	774				780			
Weight	Unit		kg	268(1)/280(2)	321(1)/332(2)		403(1)/414(2)	579(1)/604(2)		741(1)/765(2)	
Water heat exchanger	Type			Braze plate							
	Water volume		l	3		5		6		9	
	Water pressure drop	Cooling	Total	kPa	8	10	14	8	10	14	8
Air heat exchanger	Type			Air cooled coil							
Compressor	Type			Hermetically sealed scroll compressor							
	Quantity			1	2		3		4		6
Fan	Type			Axial							
	Quantity			1		2		2		4	
	Air flow rate	Cooling	Nom.	m³/min	171	185		233	370		466
Sound power level	Cooling	Nom.		dB(A)	78			80	81		83
Operation range	Air side	Cooling	Min.~Max.	°CDB	-5~43						
	Water side	Cooling	Min.~Max.	°CDB	-10 ~20						
Refrigerant	Type/GWP			R-410A/2.087,5							
	Control			Electronic expansion valve							
	Circuits	Quantity		1				2			
Refrigerant charge	Per circuit		kg	7,60		9,60		7,60		9,60	
	Per circuit		TCO <sub>Eq</sub>	15,9		20,0		15,9		20,0	
Water circuit	Piping connections diameter		inch	1-1/4" (female)				2" (female)			
	Piping		inch	1-1/4"				1-1/2"			
Unit	Starting current	Max	A	- <sup>(3)</sup>	77,7	78,7		88,7	99,8		120,7
	Running current	Max	A	22,2	25,3	26,4		35,2	47,4		67,2
Power supply	Phase/Frequency/Voltage		Hz/V	3N~/50/400							

(1) EWAQ-CWN: Version without pump. (2) EWAQ-CWP: Version with pump. (3) VRV chiller uses only inverter compressors. Starting current is always less or equal to the maximum running current.



# Air cooled multi-scroll chiller, standard efficiency, standard sound

- › Single refrigerant circuit (2 scroll compressors) with single evaporator
- › Compact design
- › Micro channel heat exchanger technology reduces the amount of refrigerant used in the system, lowering environmental impact
- › Partial and total heat recovery option available
- › Stainless steel plate heat exchanger
- › MicroTech III controller with superior control logic and easy interface

› More information about EWAQ-G-SS



Cooling Only				EWAQ-G-SS	075	085	100	110	120	140	155
Space cooling	A Condition 35°C	Pdc	kW	74,7	84,2	96,7	106,7	116,9	139,4	154,4	
	ηs,c		%	149,8	153,6	160,9	157,7	157,2	158,2	150,1	
SEER				3,8	3,9	4,1		4,0		3,8	
Cooling capacity	Nom.		kW	74,69	84,16	96,67	106,70	116,90	139,40	154,40	
Power input	Cooling	Nom.	kW	27,7	31,2	35,0	39,5	43,4	51,1	57,2	
Capacity control	Method			Staged							
	Minimum capacity		%	50	44	50	44	50	43	50	
EER				2,698		2,762	2,699	2,696	2,728	2,698	
IPLV				4,79	4,97	4,78	4,86	4,66	4,92	4,78	
Dimensions	Unit	Height	mm	1.800							
		Width	mm	1.195							
		Depth	mm	2.140	2.680			3.200			
Weight	Unit		kg	681	792	923	953	982	1.037	1.066	
		Operation weight	kg	692	802	934	963	993	1.054	1.085	
Water heat exchanger	Type			Braze plate heat exchanger							
	Water volume		l	5,60	4,90		5,60		8,10	9,40	
	Water flow rate	Cooling	Nom.	l/s	3,6	4,0	4,6	5,1	5,6	6,7	7,4
	Water pressure drop	Cooling	Nom.	kPa	15,5	27,3	36,9	31,6	36,0	27,5	25,8
Air heat exchanger	Type			Microchannel							
Compressor	Type			Driven vapour compression							
	Quantity			2							
Fan	Type			Direct propeller							
	Quantity			4		6			8		
	Air flow rate	Nom.	l/s	6.017,0	6.444,0		9.029,0		12.008,0		
	Speed		rpm	1.360							
Sound power level	Cooling	Nom.	dBA	83,0	85,0	87,0	89,0				
Sound pressure level	Cooling	Nom.	dBA	66,0	68,0	69,0	71,0				
Operation range	Air side	Cooling	Min.~Max.	°CDB			-10~42				
	Water side	Cooling	Min.~Max.	°CDB			-10~15				
Refrigerant	Type/GWP			R-410A/2.088,0							
	Circuits	Quantity		1							
Refrigerant charge	Per circuit		kg	8,5	10,4	10,7	11,5	12,9	14,1	13,4	
Piping connections	Evaporator water inlet/outlet (OD)			2" 1/2							
Unit	Starting current		A	211	262	270	317	325	365	379	
	Running current	Cooling	Nom.	A	54	58	62	70	79	89	102
		Max	A	68	74	81	89	97	114	129	
Power supply	Phase/Frequency/Voltage		Hz/V	3~/50/400							

# Air cooled multi-scroll chiller, standard efficiency, reduced sound



EWAQ-G-SS/SR

MicroTech III



> More information about EWAQ-G-SR

Cooling Only				EWAQ-G-SR	075	085	100	110	120	140	155
Space cooling	A Condition 35°C	Pdc	kW	69,3	78,9	91,0	99,7	108,6	130,4	143,4	
	ηs,c		%	149,0	149,9	156,7	152,4	151,5	153,8	150,6	
SEER				3,8		4,0	3,9		3,8		
Cooling capacity	Nom.		kW	69,33	78,85	90,96	99,68	108,60	130,40	143,40	
Power input	Cooling	Nom.	kW	29,4	33,1	36,8	42,0	46,3	54,0	61,2	
Capacity control	Method			Staged							
	Minimum capacity		%	50	44	50	44	50	43	50	
EER				2,358	2,383	2,470	2,376	2,347	2,416	2,343	
IPLV				4,67	4,85	4,71	4,78	4,50	4,85	4,61	
Dimensions	Unit	Height	mm	1.800							
		Width	mm	1.195							
		Depth	mm	2.140	2.680			3.200			
Weight	Unit		kg	711	822	953	983	1.012	1.067	1.096	
	Operation weight		kg	722	832	964	993	1.023	1.084	1.115	
Water heat exchanger	Type			Braze plate heat exchanger							
	Water volume		l	5,58	4,86		5,60		8,10	9,36	
	Water flow rate	Cooling	Nom.	l/s	3,3	3,8	4,4	4,8	5,2	6,2	6,9
	Water pressure drop	Cooling	Nom.	kPa	13,3	24,0	32,6	27,6	31,1	24,1	22,2
Air heat exchanger	Type			Microchannel							
Compressor	Type			Driven vapour compression							
	Quantity			2							
Fan	Type			Direct propeller							
	Quantity			4		6		8			
	Air flow rate	Nom.	l/s	4.523,0	5.046,0	6.787,0		9.023,0			
	Speed		rpm	1.108							
Sound power level	Cooling	Nom.	dBA	79,0	82,0	84,0	86,0				
Sound pressure level	Cooling	Nom.	dBA	62,0	65,0	66,0	68,0				
Operation range	Air side	Cooling	Min.~Max.	-10~42							
	Water side	Cooling	Min.~Max.	-10~15							
Refrigerant	Type/GWP			R-410A/2.088,0							
	Circuits	Quantity		1							
Refrigerant charge	Per circuit		kg	8,5	10,4	10,7	11,5	12,9	14,1	13,4	
Piping connections	Evaporator water inlet/outlet (OD)			2" 1/2							
Unit	Starting current	Max	A	211	262	270	317	325	365	379	
	Running current	Cooling	Nom.	A	57	61	65	74	84	93	109
	current	Max	A	68	74	81	89	97	114	129	
Power supply	Phase/Frequency/Voltage		Hz/V	3~/50/400							

# Air cooled multi-scroll chiller, high efficiency, standard sound

- › Single refrigerant circuit (2 scroll compressors) with single evaporator
- › Compact design
- › Micro channel heat exchanger technology reduces the amount of refrigerant used in the system, lowering environmental impact
- › Partial and total heat recovery option available
- › Stainless steel plate heat exchanger
- › MicroTech III controller with superior control logic and easy interface



› More information about EWAQ-G-XS

Cooling Only				EWAQ-G-XS	080	090	105	115	130	150
Space cooling	A Condition 35°C	Pdc	kW	79,8	90,3	105,3	116,8	130,0	149,0	
	ηs,c		%	155,0	164,5	167,2	166,0	169,6	165,4	
SEER				4,0	4,2	4,3	4,2	4,3	4,2	
Cooling capacity	Nom.		kW	79,79	90,26	105,30	116,80	130,00	149,00	
Power input	Cooling	Nom.	kW	25,8	29,0	33,8	37,7	42,3	48,1	
Capacity control	Method			Staged						
	Minimum capacity		%	50	44	50	44	50	43	
EER				3,099	3,108	3,121	3,099	3,100	3,099	
IPLV				4,82	5,04	4,96	5,02	4,92	5,05	
Dimensions	Unit	Height	mm	1.800				1.820		
		Width	mm	1.195						
		Depth	mm	2.680	3.200			3.800		
Weight	Unit	Operation weight		kg	734	850	987	1.024	1.086	1.123
				kg	744	860	1.002	1.040	1.102	1.144
Water heat exchanger	Type			Braze plate heat exchanger						
	Water volume		l	5,58	4,86		5,60		8,10	
	Water flow rate	Cooling	Nom.	l/s	3,8	4,3	5,0	5,6	6,3	7,1
	Water pressure drop	Cooling	Nom.	kPa	25,7	32,7	20,3	19,9	25,4	20,6
Air heat exchanger	Type			Microchannel						
	Compressor			Driven vapour compression						
Fan	Quantity			2						
	Type			Direct propeller						
	Quantity			6		8		10		
	Air flow rate	Nom.	l/s	9.029,0	9.498,0	12.008,0		15.046,0		
Sound power level	Cooling	Nom.	dBA	84,0	85,0	87,0	89,0			
			Sound pressure level	dBA	66,0	68,0	69,0	71,0		
Operation range	Air side	Cooling	Min.~Max.	-10~45						
	Water side	Cooling	Min.~Max.	-10~15						
Refrigerant	Type/GWP			R-410A/2.088,0						
	Circuits		Quantity	1						
Refrigerant charge	Per circuit		kg	9,1	12,7	13,1	13,2	16,1	15,0	
Piping connections	Evaporator water inlet/outlet (OD)			2" 1/2						
Unit	Starting current	Max	A	213	264	272	319	329	367	
	Running current	Cooling	Nom.	A	52	56	61	69	76	87
	current	Max	A	70	75	83	91	101	116	
Power supply	Phase/Frequency/Voltage		Hz/V	3~/50/400						



# Air cooled multi-scroll chiller, high efficiency, reduced sound



EWAQ-G-XS/XR

MicroTech III



> More information  
about EWAQ-G-XR

Cooling Only				EWAQ-G-XR	080	090	105	115	130	150	
Space cooling	A Condition 35°C	Pdc	kW	76,0	86,0	100,3	110,5	124,8	140,8		
	ηs,c			%	150,9	157,4	167,0	161,7	169,8	160,5	
SEER				3,8	4,0	4,3	4,1	4,3	4,1		
Cooling capacity	Nom.		kW	75,95	86,00	100,30	110,50	124,80	140,80		
Power input	Cooling	Nom.	kW	26,4	29,9	34,7	39,0	43,3	49,8		
Capacity control	Method			Staged							
	Minimum capacity		%	50	44	50	44		43		
EER				2,877	2,875	2,894	2,832	2,880	2,825		
IPLV				4,85	4,99	4,93	4,99	4,89	5,03		
Dimensions	Unit	Height	mm	1.800				1.820			
		Width	mm	1.195				1.820			
		Depth	mm	2.680	3.200			3.800			
Weight	Unit	Operation weight		kg	764	880	1.017	1.054	1.116	1.153	
				kg	774	890	1.032	1.070	1.132	1.174	
Water heat exchanger	Type			Braze plate heat exchanger							
	Water volume		l	5,58	4,86		5,60		8,10		
	Water flow rate	Cooling	Nom.	3,6	4,1	4,8	5,3	6,0	6,7		
Air heat exchanger	Water pressure drop		Cooling	Nom.	kPa	23,3	29,6	18,4	17,8	23,0	18,4
	Type			Microchannel							
Compressor	Type			Driven vapour compression							
	Quantity			2							
Fan	Type			Direct propeller							
	Quantity			6		8		10			
	Air flow rate	Nom.	l/s	6.787,0	7.356,0	9.023,0		11.309,0			
	Speed		rpm	1.108							
Sound power level	Cooling	Nom.	dBA	80,0	82,0	84,0	86,0				
Sound pressure level	Cooling	Nom.	dBA	62,0	65,0	66,0	68,0	67,0			
Operation range	Air side	Cooling	Min.~Max.	-10~45							
	Water side	Cooling	Min.~Max.	-10~15							
Refrigerant	Type/GWP			R-410A/2.088,0							
	Circuits		Quantity	1							
Refrigerant charge	Per circuit		kg	9,1	12,7	13,1	13,2	16,1	15,0		
Piping connections	Evaporator water inlet/outlet (OD)			2" 1/2							
Unit	Starting current		Max	A	213	264	272	319	329	367	
	Running current		Cooling	Nom.	A	54	58	63	71	78	90
	current		Max	A	70	75	83	91	101	116	
Power supply	Phase/Frequency/Voltage		Hz/V	3~/50/400							

# Air cooled screw inverter chiller, high efficiency, standard/low sound

- › High efficiency with leader-of-class ESEER
- › Inverter stepless single-screw compressor
- › Highly efficient fans with patented blade profile for quiet operation
- › Extensive option list (heat recovery option available)
- › Wide operating range
- › Low starting current
- › MicroTech III controller with superior control logic and easy interface

› More information about EWAD-CZXS



› More information about EWAD-CZXL



Cooling Only				EWAD-CZXS/XL	C12	C13	C14	C15	C16	C17	C18
Space cooling	A Condition 35°C Pdc			kW	1.232	1.303,04	1.444,04	1.538	1.616,03	1.701	1.795
	n <sub>s,c</sub>			%	205,8	204,6	206,2	201,4	199,8	203	207,4
SEER				5,22	5,19	5,23	5,11	5,07	5,15	5,26	
Cooling capacity	Nom.			kW	1.232	1.303	1.444	1.538	1.616	1.701	1.795
Power input	Cooling	Nom.		kW	404,3	446,6	493,7	538,4	564,3	595,9	618,7
Capacity control	Method		Variable								
	Minimum capacity		%								
EER				3,047	2,919	2,926	2,856	2,863	2,855	2,9	
IPLV				5,58	5,45	5,61	5,75	5,65	5,46	5,29	
Dimensions	Unit	Height	mm								
		Width	mm		2.540						
		Depth	mm		2.285						
			mm		10.325	11.625	12.525		13.425	14.325	
Weight (XS)	Unit			kg	8.570	8.970	9.600	9.940	11.370	12.190	12.920
	Operation weight				kg	8.960	9.360	9.980	10.320	12.220	13.040
Weight (XL)	Unit			kg	8.850	9.250	9.880	10.220	11.790	12.610	13.340
	Operation weight				kg	9.240	9.640	10.260	10.600	12.640	13.460
Water heat exchanger	Type		Shell and tube								
	Water volume		l		383		374		850		871
	Water flow rate	Cooling	Nom.	l/s	59	62,4	69,2	73,7	77,4	81,5	86
	Water pressure drop	Cooling	Nom.	kPa	47	52,1	61,9	71,9	62,8	69,1	65,1
Air heat exchanger	Type		High efficiency fin and tube type								
Compressor	Type		Driven vapour compression								
	Quantity		2								
Fan	Type		Direct propeller								
	Quantity		20								
	Air flow rate	Nom.	l/s	108.376	119.214	130.051	129.455	140.143	151.130		
	Speed			rpm	900						
Sound power level (XS)	Cooling	Nom.	dBA	104				106			
Sound power level (XL)	Cooling	Nom.	dBA	101				103			
Sound pressure level (XS)	Cooling	Nom.	dBA	81				83			
Sound pressure level (XL)	Cooling	Nom.	dBA	78				80			
Operation range	Air side	Cooling	Min.~Max.	°CDB	-18~-50						
	Water side	Cooling	Min.~Max.	°CDB	-8~-15						
Refrigerant	Type/GWP		R-134a/1.430								
	Charge		kg	250	280	320	340	350			
	Circuits		Quantity	2						3	
	Evaporator water inlet/outlet (OD)		mm	219,1						273	
Unit	Starting current	Max	A	590	626	709	772	848	899	949	
	Running current	Cooling	Nom.	A	636	698	769	837	881	931	970
	current	Max	A	824	877	979	1.081	1.132	1.193	1.255	
	Power supply	Phase/Frequency/Voltage		Hz/V	3~/50/400						

# Air cooled screw inverter chiller, high efficiency, reduced sound



EWAD-CZXS/XL/XR

MicroTech III



> More information about EWAD-CZXR

Cooling Only				EWAD-CZXR	C11	C12	C13	C14	C15	C16	C17	
Space cooling	A Condition 35°C	Pdc	kW	1.166	1.231,01	1.327	1.437	1.539	1.624,03	1.706,04		
		η <sub>s,c</sub>	%	219	202,2	206,2	199,8	211,4	214,6	220,2		
SEER				5,55	5,13	5,23	5,07	5,36	5,44	5,58		
Cooling capacity	Nom.		kW	1.166	1.231	1.327	1.437	1.539	1.624	1.706		
Power input	Cooling	Nom.	kW	411,8	458	492	523,4	585,5	616,7	638,1		
Capacity control	Method			Variable								
	Minimum capacity		%	20				13				
EER				2,831	2,681	2,692	2,745	2,628	2,634	2,673		
IPLV				5,96	5,67	6,03	6,21	6,17	5,89	5,85		
Dimensions	Unit	Height	mm	2.540								
		Width	mm	2.285								
		Depth	mm	10.325		11.625		12.525		13.425	14.325	
Weight	Unit		kg	9.120	9.530	10.180	10.530	12.150	12.990	13.740		
	Operation weight		kg	9.500	9.920	10.550	10.910	13.000	13.840	14.610		
Water heat exchanger	Type			Shell and tube								
	Water volume		l	383		374		850		871		
	Water flow rate	Cooling	Nom.	l/s	55,8	58,9	63,6	68,8	73,7	77,8	81,7	
	Water pressure drop	Cooling	Nom.	kPa	43,2	47,6	56,5	65,8	57,3	63,2	60,1	
Air heat exchanger	Type			High efficiency fin and tube type								
Compressor	Type			Driven vapour compression								
	Quantity			2				3				
Fan	Type			Direct propeller								
	Quantity			20		22		24		26	28	
	Air flow rate	Nom.	l/s	83.072		91.380		99.687		107.994		116.301
	Speed		rpm	700								
Sound power level	Cooling	Nom.	dBA	97				99				
Sound pressure level	Cooling	Nom.	dBA	74				76				
Operation range	Air side	Cooling	Min.~Max.	-18~-50								
	Water side	Cooling	Min.~Max.	-8~-15								
Refrigerant	Type/GWP			R-134a/1.430								
	Charge		kg	250		280		320		340		350
	Circuits	Quantity		2				3				
	Piping connections	Evaporator water inlet/outlet (OD)	mm	219,1					273			
Unit	Starting current	Max	A	576	606	686	756	825	873	921		
	Running current	Cooling	Nom.	A	647	709	782	859	912	960	998	
	current	Max	A	796	841	940	1.048	1.098	1.157	1.215		
Power supply	Phase/Frequency/Voltage		Hz/V	3~/50/400								

# Air cooled screw chiller with free cooling, high efficiency, standard/low sound

- › Free cooling chiller for space cooling and industrial processes
- › Stepless single-screw compressor
- › Greater energy savings and reduced CO<sub>2</sub> emissions during cold season
- › Wide operating range
- › MicroTech III controller with superior control logic and easy interface

› More information about EWAD-CFXL



› More information about EWAD-CFXS



Cooling only				EWAD-CFXS/XL																	
				640	770	850	900	C10	C11	C12	C13	C14	C15	C16							
Cooling capacity	Nom.			kW			640 (1) / 415 (2)	772 (1) / 510 (2)	852 (1) / 583 (2)	902 (1) / 612 (2)	1.027 (1) / 701 (2)	1.089 (1) / 734 (2)	1.269 (1) / 902 (2)	1.349 (1) / 957 (2)	1.435 (1) / 963 (2)	1.493 (1) / 1.013 (2)	1.555 (1) / 1.039 (2)				
Power input	Cooling	Nom.		kW			257 (1) / 53,7 (2)	272 (1) / 62,0 (2)	293 (1) / 64,7 (2)	324 (1) / 69,8 (2)	360 (1) / 75,7 (2)	399 (1) / 83,4 (2)	397 (1) / 86,4 (2)	439 (1) / 92,8 (2)	454 (1) / 101 (2)	492 (1) / 109 (2)	530 (1) / 115 (2)				
Capacity control	Method			Stepless																	
	Minimum capacity			%			12,5														
EER							2,49 (1) / 11,91 (2)	2,84 (1) / 12,44 (2)	2,90 (1) / 13,17 (2)	2,78 (1) / 12,93 (2)	2,85 (1) / 13,56 (2)	2,73 (1) / 13,05 (2)	3,19 (1) / 14,68 (2)	3,08 (1) / 14,55 (2)	3,16 (1) / 14,21 (2)	3,04 (1) / 13,72 (2)	2,93 (1) / 13,50 (2)				
IPLV							3,86	4,03	4,10	4,05	4,00	3,95	4,36	4,25	4,36	4,35	4,26				
Dimensions	Unit	Height		mm																	
		Width		2.565																	
		Depth		2.480																	
Weight (XS)	Unit	kg		6.300	7.200	8.100	9.000			10.800			12.540			10.800					
		Operation weight		kg	7.760	8.340	8.900	10.160	10.420	11.900	12.540	12.620	12.670	14.516	14.596	14.646					
Weight (XL)	Unit	kg		8.050	8.620	9.190	10.450	10.710	12.190	12.830	12.910	12.960	14.806	14.886	14.936						
		Operation weight		kg	8.795	9.390	9.995	11.459	11.719	13.566	14.806	14.886	14.936								
Water heat exchanger	Type			Single pass shell & tube																	
	Water flow rate	Cooling	Nom.	l/s	27,8 (1) / 27,8 (2)	33,5 (1) / 33,5 (2)	37,0 (1) / 37,0 (2)	39,2 (1) / 39,2 (2)	44,6 (1) / 44,6 (2)	47,3 (1) / 47,3 (2)	55,1 (1) / 55,1 (2)	58,6 (1) / 58,6 (2)	62,4 (1) / 62,4 (2)	64,9 (1) / 64,9 (2)	67,6 (1) / 67,6 (2)						
					Water pressure drop	Cooling	Nom.	kPa	85 (1) / 128 (2)	105 (1) / 172 (2)	90 (1) / 178 (2)	101 (1) / 198 (2)	111 (1) / 245 (2)	124 (1) / 272 (2)	98 (1) / 232 (2)	110 (1) / 259 (2)	139 (1) / 305 (2)	150 (1) / 328 (2)	162 (1) / 354 (2)		
Water volume	l	741	771	808					1.012			1.372			1.965						
Air heat exchanger	Type			High efficiency fin and tube type																	
Compressor	Type			Driven vapour compression																	
	Quantity			2																	
Fan	Type			Direct propeller																	
	Air flow rate	Nom.		l/s	50.368	60.441	70.515			80.588			95.253								
Sound power level (XS)	Cooling	Nom.		dBA	100		101			102			103								
Sound power level (XL)	Cooling	Nom.		dBA	96	97			98			99									
Sound pressure level (XS)	Cooling	Nom.		dBA	79	80			81			80									
Sound pressure level (XL)	Cooling	Nom.		dBA	76		77			77			77								
Operation range	Air side	Cooling	Min.~Max.	°CDB	-20~-45																
	Water side	Cooling	Min.~Max.	°CDB	-8~-15																
Refrigerant	Type/GWP			R-134a/1.430																	
	Circuits			Quantity	2																
Refrigerant charge				kg/TCO,Eq	64,0/91,5	73,0/104,4	81,0/115,8			91,0/130,1			107,0/153,0			112,5/160,9			124,0/177,3		
Piping connections	Evaporator water inlet/outlet (OD)			mm	168,3																
Unit	Starting current	Max	A		605	619	658			924	971	1.030			1.073			1.086			
			Running current	Cooling	Nom.	A		404	430	467	515	568	628	636	701	720	773	825			
						Max		A	476	510	561	605	672	731	811	875	929	982			
Power supply	Phase/Frequency/Voltage			Hz/V	3~/50/400																

(1) Cooling: entering evaporator water temp. 16°C; leaving evaporator water temp. 10°C; ambient air temp. 35°C; full load operation.

(2) Data is calculated at ambient air temperature 5°C, inlet water temperature 16°C.

# Air cooled screw chiller with free cooling, high efficiency, reduced sound



> More information about EWAD-CFXR

Cooling Only				EWAD-CFXR														
				600	740	820	870	980	C10	C11	C12	C13	C14	C15				
Cooling capacity	Nom.			kW		602 (1) / 374 (2)	739 (1) / 468 (2)	821 (1) / 539 (2)	866 (1) / 562 (2)	981 (1) / 644 (2)	1.034 (1) / 670 (2)	1.229 (1) / 825 (2)	1.302 (1) / 866 (2)	1.374 (1) / 889 (2)	1.424 (1) / 909 (2)	1.476 (1) / 929 (2)		
Power input	Cooling	Nom.			kW		263 (1) / 46,6 (2)	278 (1) / 56,2 (2)	299 (1) / 58,5 (2)	334 (1) / 63,1 (2)	368 (1) / 68,5 (2)	412 (1) / 74,4 (2)	403 (1) / 80,0 (2)	450 (1) / 87,5 (2)	466 (1) / 93,4 (2)	511 (1) / 103 (2)	556 (1) / 109 (2)	
Capacity control	Method			Stepless														
	Minimum capacity			%														
EER					2,29 (1) / 12,91 (2)		2,66 (1) / 13,17 (2)	2,75 (1) / 14,04 (2)	2,59 (1) / 13,71 (2)	2,67 (1) / 14,33 (2)	2,51 (1) / 13,89 (2)	3,05 (1) / 15,36 (2)	2,90 (1) / 14,87 (2)	2,95 (1) / 14,7 (2)	2,79 (1) / 13,85 (2)	2,66 (1) / 13,56 (2)		
IPLV					4,09		4,15	4,16	4,20	4,10	4,08	4,42	4,37	4,42	4,28			
Dimensions	Unit	Height			mm													
		Width			2.565													
		Depth			2.480													
Weight	Unit			kg		6.300	7.200	8.100	9.000	10.450	10.710	12.190	12.830	12.910	12.960			
	Operation weight			kg		8.795	9.390	9.995	11.459	11.719	13.566	14.806	14.886	14.936				
Water heat exchanger	Type			Single pass shell & tube														
	Water flow rate	Cooling	Nom.	l/s		26,2 (1) / 26,2 (2)	32,1 (1) / 32,1 (2)	35,7 (1) / 35,7 (2)	37,6 (1) / 37,6 (2)	42,6 (1) / 42,6 (2)	44,9 (1) / 44,9 (2)	53,4 (1) / 53,4 (2)	56,6 (1) / 56,6 (2)	59,7 (1) / 59,7 (2)	61,9 (1) / 61,9 (2)	64,1 (1) / 64,1 (2)		
	Water pressure drop	Cooling	Nom.	kPa		76 (1) / 115 (2)	97 (1) / 159 (2)	84 (1) / 167 (2)	93 (1) / 184 (2)	102 (1) / 225 (2)	113 (1) / 248 (2)	92 (1) / 219 (2)	103 (1) / 243 (2)	128 (1) / 282 (2)	137 (1) / 301 (2)	146 (1) / 321 (2)		
	Water volume			l		741	771	808	1.012	1.372	1.965							
Air heat exchanger	Type			High efficiency fin and tube type														
Compressor	Type			Driven vapour compression														
	Quantity			2														
Fan	Type			Direct propeller														
	Quantity			10		12	14	16	20									
	Air flow rate	Nom.	l/s		38.935	46.722	54.508	62.295	73.011									
	Speed			rpm		715												
Sound power level	Cooling	Nom.			92		94		95									
Sound pressure level	Cooling	Nom.			71		72		73		72		73					
Operation range	Air side	Cooling	Min.~Max.	°CDB		-20~45												
	Water side	Cooling	Min.~Max.	°CDB		-8~15												
Refrigerant	Type/GWP			R-134a/1.430														
	Circuits			2														
Refrigerant charge	Per circuit			kg		64,0	73,0	81,0	91,0	107,0	112,5	124,0						
	Per circuit			TCO <sub>2</sub> Eq		91,5	104,4	115,8	130,1	153,0	160,9	177,3						
Piping connections	Evaporator water inlet/outlet (OD)			DN150PN16(168,3mm)				DN200PN16(219,1mm)				DN250PN16(273mm)						
Unit	Starting current	Max			A		598	611	648	912	960	1.016	1.059	1.072				
	Running current	Cooling	Nom.			A		411	439	473	526	580	647	645	717	738	800	862
	Max			A		462	493	542	585	649	708	783	847	901	954			
Power supply	Phase/Frequency/Voltage			Hz/V														
			3~/50/400															

(1)Cooling: entering evaporator water temp. 16°C; leaving evaporator water temp. 10°C; ambient air temp. 35°C; full load operation.

(2)Data is calculated at ambient air temperature 5°C, inlet water temperature 16°C.

# Why choose Daikin?

**Daikin were the among first to pioneer the use of inverters in air cooled screw chillers. And today, our next generation of inverter technology makes both comfort and process cooling even more efficient and cost-effective.**

With the highest efficiency at both partial and full load, installers and building owners can give end-users better results all year round comfort – with lower noise levels and higher energy efficiency than ever before.

For over a decade, hundreds of sites around the world have relied on Daikin inverter driven single screw compressors to reduce their running costs without compromising on climate comfort or performance.

With the EWAD-TZB chiller, Daikin has once again improved the chiller performances by increasing the efficiency of the in-house developed compressor with integrated inverter: VVR technology, DC motors,... Further improvements are made by introducing new technologies as microchannel condenser coils and advanced electronic expansion valves.

Now also available with HFO refrigerant R-1234ze(E).



The selection of R-1234ze(E) allows to minimize the global warming impact of screw compressor chillers thanks to low Global Warming Potential in combination with high energy efficiency.

R-1234ze(E) is a HFO refrigerant (Hydro Fluoro Olefins). Its Ozone Depletion Potential (ODP) is equal to zero (0) and the Global Warming Potential (GWP) is 7.



## TZ Chiller series

Energy efficient cooling that does not compromise on comfort or performance

# Why choose TZ chiller series?

## 1 Top class efficiency:

**R-134a**

EER up to 3.93  
SEER up to 6.35

**R-1234ze(E)**

EER up to 3.86  
SEER up to 5.87

## Best choice for every application

Rapid payback: 1 year for process cooling and 3 years for comfort cooling applications



### ✓ New generation of Daikin inverter screw compressors

- › Integrated inverter, refrigerant cooled
- › Variable volume ratio technology

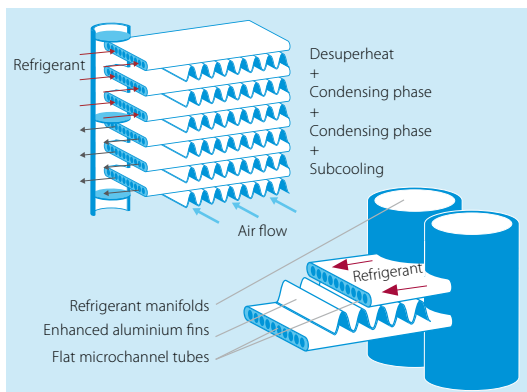
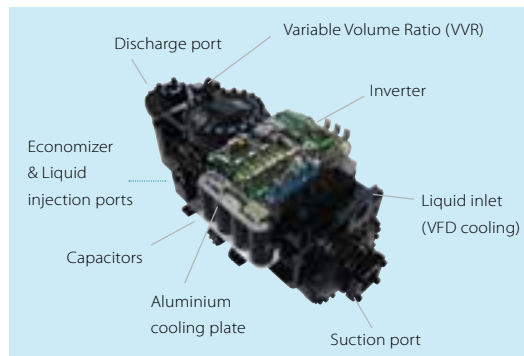

### ✓ Microchannel condenser coils

- › High thermal efficiency
- › Small volume, resulting in a small refrigerant charge
- › Light & durable design
- › Easy cleaned

### ✓ VVR (Variable Volume Ratio)

The operating conditions of a chiller are subjected to sensible changes due to the variation of ambient temperature and load request from the plant.

Screw compressors increase the pressure of the refrigerant by forcing it into a progressive smaller volume, from the suction to the discharge port. Once that the geometry of the compressor is defined the volume ratio is also defined.

Daikin compressors can modify their own geometry thanks to variable volume ratio (VVR). The volume ratio will change by moving the sliding valves. VVR changes the point at which the gas leaves the compressor, and therefore changes the pressures at discharge which will be optimal at any condition.

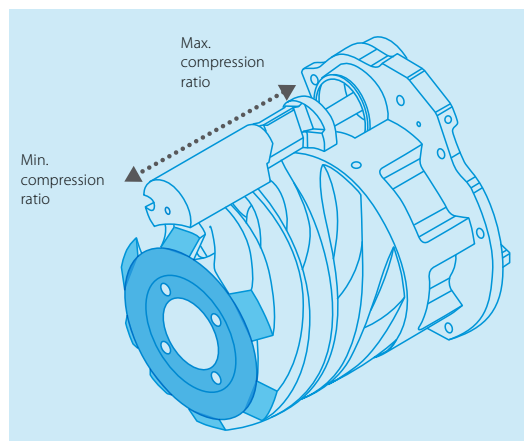



## 2 Silent operation – for distraction-free work

Nothing disrupts the workplace more than the sound of machinery. So our engineers have brought the sound power levels right down to just 90 dB(A)\* at full load operating conditions - and even lower at part load conditions. Thanks to the special acoustic executions on the compressor and a custom Daikin fan design with reduced noise impact and vibration, the EWAD-TZB is ideal for even the most sound-sensitive environment.

\*400 kW size

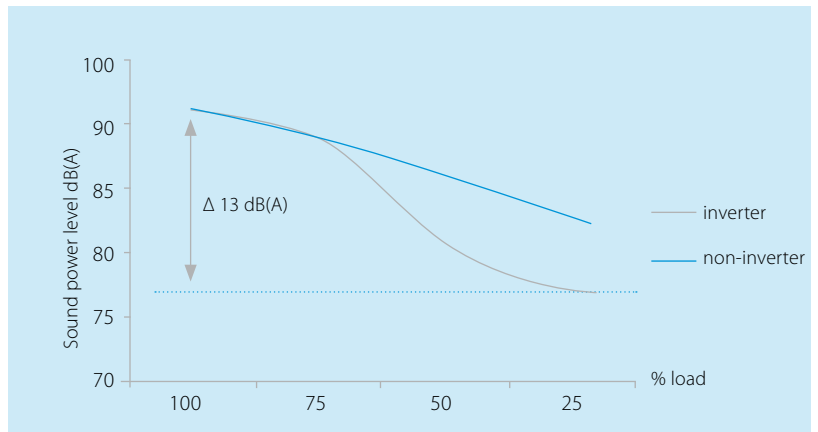

## 3 Application flexibility

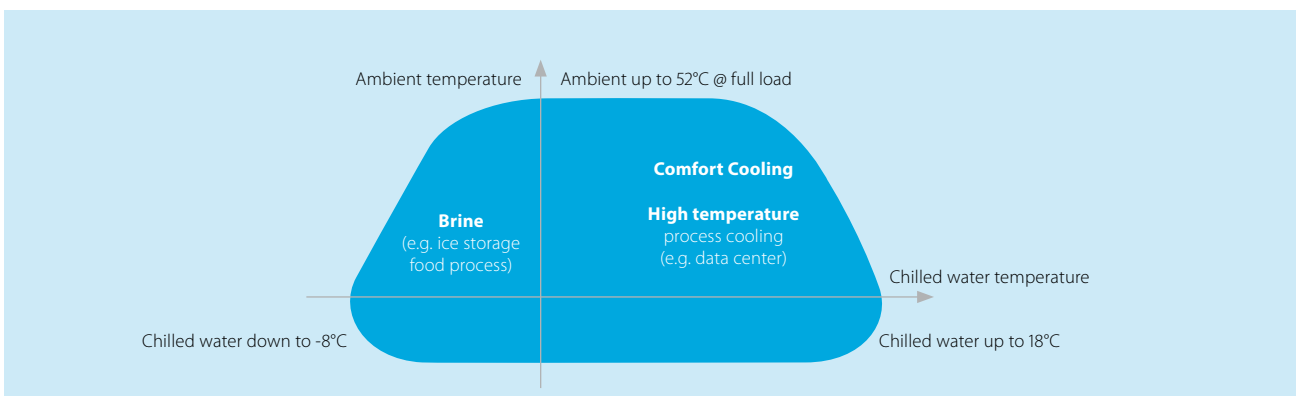





# Providing a lifetime of comfort in the most flexible way

## 4 Compact design

The EWAD-TZ keeps installation space at a minimum, so it's ideal for both new and retrofit projects. In particular, the highly efficient compressor with its integrated inverter allows us to mount more compact heat exchangers in the frame and, combined with the integrated compact control panel, deliver more power from a reduced footprint.

## 5 Simple to install. Even simpler to maintain

Our chillers are wired at the factory and are also pre-commissioned, with the unit's software tuned and set points already established. They also integrate easily with existing building management systems. So on site, all that is required is to plug the unit into the power supply, connect any pipes and wires, and switch the unit on.

## 6 Proven reliability

All our chillers and compressors are subjected to intensive performance, acoustic, endurance and vibration tests in Daikin factories and at selected job-sites - even at extreme working conditions. To ensure maximum reliability in every component - and the right, lifelong technical solution for your application.

## 7 Extensive options list

- › **Rapid restart** - when a loss of cooling would be catastrophic, the chiller can restart within 30 seconds of the power being restored and reach full-load cooling capacity in less than 6 minutes.
- › **VFD pumps** - variable frequency pumps can be used to optimise the working efficiency of the chiller and thus maximise energy savings, also in primary only variable flow systems.
- › **Refrigerant leak detection** - rapid advanced warning of trouble, so you can avoid any environmentally harmful and potentially costly leaks in the refrigerant system.
- › **Heat recovery** - a plate to plate heat exchanger for each refrigerant circuit is installed in series to the condenser coil. 15 to 85 % of the total heat rejection of the chiller can be recovered
- › **Partial heat recovery** - a plate to plate heat exchanger for each refrigerant circuit is installed in series to the air condenser coil. The plant manager controls the operation of the pump on the recovery circuit. 15 to 20 % of the total heat rejection of the chiller can be recovered
- › **Smart sequencing capability** - master/slave sequencing function up to 4 units connected together for system optimisation and without the need of external control systems.



# Air cooled screw inverter chiller, standard efficiency, reduced sound



> More information about EWAD-TZSRB



Cooling Only				EWAD-TZSRB																								
				160	190	240	270	300	360	380	450	495	570	610	660	700	820	900	990	C10	C11							
Space cooling	A Condition 35°C	Pdc	kW	169,1	200,88	235,29	268,82	305,99	351,41	394,01	454,57	499,14	568,6	610,43	658,99	699,87	799,95	894,94	956,14	1.013,27	1.067,02							
	ηs,c			%	168,2	172,6	169,4	175,4	177	183	172,2	170,6	174,2	179,4	188,6	181,8	184,6	215	213,4	213,8	216,2	217,8						
SEER				4,28	4,39	4,31	4,46	4,5	4,65	4,38	4,34	4,43	4,56	4,79	4,62	4,69	5,45	5,41	5,42	5,48	5,52							
Cooling capacity	Nom.		kW	169,1	200,9	235,3	268,8	306	351,4	394	454,6	499,1	568,6	610,4	659	699,9	800	895	956	1.013	1.067							
Power input	Cooling	Nom.	kW	56,48	69,9	82,99	89,94	108,6	118	140,2	164,8	175,4	199,1	218,4	240,3	250,3	247,8	294,1	316	335,6	358,9							
Capacity control	Method		Variable																									
	Minimum capacity		%	37	31	34	29	25	24	16	17	16	14	13	12			10										
EER				2,995	2,874	2,835	2,989	2,817	2,954	2,81	2,759	2,846	2,856	2,795	2,742	2,796	3,229	3,043	3,016	3,018	2,973							
IPLV				5,3	5,27	5,04	5,19	5,37	5,53	5,3	5,26	5,43	5,6	5,61	5,6	5,67	5,92	5,74	5,77	5,75	5,86							
Dimensions	Unit	Height	mm	2.540																								
		Width	mm	2.282																								
		Depth	mm	2.331			4.131			5.030		5.887			6.786		7.787		8.687		9.587		10.488					
Weight	Unit	kg		2.121		2.411		2.784		4.044		4.281		4.588		4.907		5.104		6.178		6.310		6.652		6.930		7.258
		Operation weight		2.160		2.454		2.836		4.173		4.444		4.751		5.169		5.359		6.458		6.760		7.102		7.380		7.708
Water heat exchanger	Type		Plate heat exchanger																									
	Water volume		l	2025	26,1	37,35	26,1	37,35	49,5	158	164	158		270	255		283	485			453							
	Water flow rate	Cooling	Nom.	l/s	8,1	9,6	11,2	12,9	14,6	16,8	18,8	21,7	23,9	27,2	29,2	31,5	33,5	38,3	42,8	45,7	48,5	51						
	Water pressure drop	Cooling	Nom.	kPa	25	19,3	15,4	32,6	25,2	25,9	25,8	32,2	43,9	55,5	38,6	32,2	35,9	52,1	36,3	41	45,6	36,3						
Air heat exchanger	Type		Microchannel																									
Compressor	Type		Driven vapour compression																									
	Quantity		1									2																
Fan	Type		Direct propeller																									
	Quantity		4			6			8			10		12			14		16		18		20		22			
	Air flow rate	Nom.	l/s	15.109			22.664			30.219		29.650		36.920			44.475			51.745		59.299		66.570		74.124	81.394	
	Speed	rpm	700																									
Sound power level	Cooling	Nom.	dB(A)	86	87			88			90			91			92		94			95						
Sound pressure level	Cooling	Nom.	dB(A)	67	68			69			70			71			73											
Operation range	Air side	Cooling	Min.~Max.	-18~-47																								
	Water side	Cooling	Min.~Max.	-8~-18																								
Refrigerant	Type/GWP		R-134a/1.430																									
	Charge		kg	27	29	33	38	41	52	58	59	68	75	77	83	90	104	117	130	143								
	Circuits	Quantity	1									2																
Refrigerant charge	Per circuit		TCO <sub>2</sub> Eq	38,6	41,5	47,2	54,3	58,6	74,4	41,5	42,2	48,6	53,6	55,1	59,3	64,4	74,4	83,7	93,0	102,2								
Piping connections	Evaporator water inlet/outlet (OD)		mm	88,9			114,3			139,7			168,3			219,1												
Unit	Running current	Cooling	Nom.	A	102	123	188	177	188	200	247	374	368	363	378	398	416	422	496	530	561	599						
		Max	A	130	149	160	187	220	246	298	320	350	374	439	466	486	523	585	635	688	745							
Power supply	Phase/Frequency/Voltage		Hz/V	3~/50/400																								

# Air cooled screw inverter chiller, high efficiency, standard/low sound

- › High energy efficiency both at full and part load conditions
- › Inverter stepless single-screw compressor with DC electrical motor
- › Advanced compressor technology featuring integrated inverter and variable volume ratio (VVR)
- › Continuous fans speed modulation thanks to inverter driven fans to improve part load efficiency
- › Compact design for small footprint and minimized installation space
- › Low operating sound levels are achieved by the latest compressor and fan design
- › One or two truly independent refrigerant circuits for outstanding reliability

› More information about EWAD-TZXSB



› More information about EWAD-TZXLB



			EWAD-TZXSB/XLB																		
			190	220	240	290	320	360	420	450	540	570	610	660	680	770	850	910	C10	C11	
Cooling Only	Space cooling	A Condition 35°C Pdc	kW																		
		ηs,c	%																		
SEER			4,95	5,04	4,96	5,15	5,14	4,96	5,03	5,07	5,1	5,04	5,17	5,23	5,21	5,79	5,74	5,91	6,15	6	
Cooling capacity	Nom.		kW																		
Power input	Cooling	Nom.	kW																		
Capacity control	Method		Variable																		
		Minimum capacity	%																		
EER			3,46	3,343	3,304	3,3	3,127	3,304	3,156	3,261	3,236	3,111	3,127	3,164	3,085	3,374	3,195	3,306	3,3	3,265	
IPLV			6,26	6,15	6,19	6,17	6,4	6,3	6,22	6,29	6,31	6,25	6,21	6,26	6,08	6,19	6,29	6,24			
Dimensions	Unit	Height	mm																		
		Width	mm																		
		Depth	mm																		
Weight (XSB)	Unit		kg																		
	Operation weight		kg																		
Weight (XLB)	Unit		kg																		
	Operation weight		kg																		
Water heat exchanger	Type		Plate heat exchanger																		
		Water volume	l																		
		Water flow rate	Cooling	Nom.	l/s																
		Water pressure drop	Cooling	Nom.	kPa																
Air heat exchanger	Type		Microchannel																		
		Compressor		Driven vapour compression																	
Fan	Type		Direct propeller																		
		Quantity	1																		
Sound power level (XSB)	Cooling	Nom.	dBA																		
		Sound power level (XLB)	Cooling	Nom.	dBA																
Sound pressure level (XSB)	Cooling	Nom.	dBA																		
		Sound pressure level (XLB)	Cooling	Nom.	dBA																
Operation range	Air side	Cooling	Min.~Max.	°CDB																	
	Water side	Cooling	Min.~Max.	°CDB																	
Refrigerant	Type/GWP		R-134a/1.430																		
		Charge	kg																		
Refrigerant charge	Per circuit		TCO <sub>2</sub> Eq																		
		Circuits	Quantity	1																	
Piping connections	Evaporator water inlet/outlet (OD)mm		mm																		
		Unit	Running	Cooling	Nom.	A															
Power supply	Phase/Frequency/Voltage		Hz/V																		
			3~/50/400																		

# Air cooled screw inverter chiller, high efficiency, reduced sound



> More information about EWAD-TZXR

Cooling Only				EWAD-TZXR																		
				190	220	240	290	320	360	420	450	540	570	610	660	680	770	850	910	C10	C11	
Space cooling	A Condition 35°C	Pdc	kW	180,41	211,34	239,54	276,79	313,2	360,28	416,8	472,11	528,32	562,28	598,77	638,64	677,38	763,85	850,14	911,93	1.001,2	1.045,41	
	ηs,c		%	195	198,6	195,4	203	202,6	194,6	198,2	199	200,2	198,2	202,6	205	204,6	229,8	229,4	233,4	242	237,8	
SEER				4,95	5,04	4,96	5,15	5,14	4,94	5,03	5,05	5,08	5,03	5,14	5,2	5,19	5,82	5,81	5,91	6,18	6,02	
Cooling capacity	Nom.		kW	180,4	211,3	239,5	276,8	313,2	360,3	416,8	472,1	528,3	562,3	598,8	638,6	677,4	764	850	912	1.001	1.045	
Power input	Cooling	Nom.	kW	52,13	63,22	72,5	83,87	100,2	109,5	132,1	145,6	164,3	181,9	192,5	202	220,9	226,5	266,8	275,4	303,1	320,6	
Capacity control	Method			Variable																		
	Minimum capacity		%	34	29	34	29	25	17	16	17	16	15	14	13				10			
EER				3,46	3,343	3,304	3,3	3,127	3,29	3,156	3,243	3,215	3,092	3,111	3,146	3,067	3,373	3,186	3,311	3,302	3,26	
IPLV				6,26	6,15	6,19	6,17	6,37	6,3	6,2	6,26	6,27	6,24	6,18	6,26	6,08	6,19	6,29	6,24			
Dimensions	Unit	Height	mm	2.540																		
		Width	mm	2.282																		
		Depth	mm	3.231		4.131		5.030		5.887		6.786		7.684		7.787		8.687	9.587	10.488		
Weight	Unit		kg	2.411		2.784		4.281	4.588	4.907	5.078	5.434	6.178	6.310	6.652	6.930	7.258					
	Operation weight		kg	2.454		2.836		4.444	4.751	5.169	5.341	5.718	6.458	6.760	7.102	7.380	7.708					
Water heat exchanger	Type			Plate heat exchanger								Shell and tube										
	Water volume		l	26,1	37,35	49,5		158		255		301		485		453						
	Water flow rate	Cooling	Nom.	l/s	8,6	10,1	11,5	13,2	15	17,2	19,9	22,6	25,3	26,9	28,6	30,5	32,4	36,6	40,7	43,6	47,9	50
	Water pressure drop	Cooling	Nom.	kPa	16,4	13,2	16,2	17,1	21	34,2	31,1	39,7	36,6	41	27,1	30,4	33,2	40,3	33,3	37,3	42,3	34,2
Air heat exchanger	Type			Microchannel																		
Compressor	Type			Driven vapour compression																		
	Quantity			1								2										
Fan	Type			Direct propeller																		
	Quantity			6		8		10		12		14		16		18	20	22				
	Air flow rate	Nom.	l/s	22.664		30.219		36.920		44.475		51.745		59.299		66.570	74.124	81.394				
	Speed		rpm	700																		
Sound power level	Cooling	Nom.	dB(A)	88		89		90		91		92		94		95						
Sound pressure level	Cooling	Nom.	dB(A)	68		69		70		71		73										
Operation range	Air side	Cooling	Min.~Max.	-18~50																		
	Water side	Cooling	Min.~Max.	-8~18											-15~20							
Refrigerant	Type/GWP			R-134a/1.430																		
	Charge		kg	36	39	40	51	64	74	80	89	96	104	117	130	143						
	Circuits	Quantity		1								2										
Refrigerant charge	Per circuit	TCO <sub>2</sub> Eq		51,5	55,8	57,2	72,9	45,8	52,9	57,2	63,6	68,6	74,4	83,7	93,0	102,2						
Piping connections	Evaporator water inlet/outlet (OD)	mm		88,9		114,3		139,7		168,3		219,1										
Unit	Running	Cooling	Nom.	A	110	113	186	192	226	231	373,0	385	393	417	389	396	395	453	471	502	539	
	current	Max		A	130	149	166	198	225	256	292	333	358	385	491	450	478	508	562	590	640	694
Power supply	Phase/Frequency/Voltage	Hz/V		3~/50/400																		

# Air cooled screw inverter chiller, premium efficiency, standard/low sound

- › Premium energy efficiency both at full and part load conditions
- › Inverter stepless single-screw compressor with DC electrical motor
- › Advanced compressor technology featuring integrated inverter and variable volume ratio (VVR)
- › Continuous fans speed modulation with EC fans for even higher part load efficiency
- › Compact design for small footprint and minimized installation space
- › Low operating sound levels are achieved by the latest compressor and fan design
- › One or two truly independent refrigerant circuits for outstanding reliability

› More information about EWAD-TZPSB



› More information about EWAD-TZPLB



Cooling Only				EWAD-TZPSB/PLB															
				190	220	240	290	300	350	420	495	550	620	720	820	950			
Space cooling	A Condition 35°C ηs,c	Pdc	kW	183,6	216,12	244,42	281,93	323,37	378,96	437,31	501,15	543,03	620	717	832,86	949,85			
			%	204,6	210,2	208,6	209	217	207	211,4	221,8	219	241,4	245,8	249	249,4			
SEER				5,2	5,33	5,29	5,3	5,5	5,25	5,36	5,62	5,55	6,11	6,22	6,3	6,31			
Cooling capacity	Nom.		kW	183,60	216,1	244,4	281,9	323,4	379	437,3	501,2	543	620	717	833	950			
Power input	Cooling	Nom.	kW	50,5	60,72	68,74	83,43	95,89	104,6	124,9	139,1	151,4	178,8	182,3	220,4	252,5			
				Capacity control	Method	Variable													
			%	34	29	34	29	27	19	20	17	10							
EER				3,637	3,559	3,555	3,379	3,372	3,623	3,502	3,603	3,586	3,468	3,933	3,78	3,763			
IPLV				6,49	6,35	6,41	6,35	6,21	6,52	6,58	6,55	6,51	6,47	6,73	6,6	6,64			
Dimensions	Unit	Height	mm	2.540															
		Width	mm	2.282															
		Depth	mm	4.131			5.030	5.887	6.786	7.684	8.579	9.480	9.587	10.488	11.387				
Weight (PSB)	Unit		kg	2.784			3.055	4.907	5.078	5.434	6.212	6.532	6.930	7.258	7.550				
	Operation weight		kg	2.836			3.106	5.169	5.341	5.718	6.522	6.830	7.380	7.708	8.000				
Weight (PLB)	Unit		kg	2.784			3.055	4.907	5.078	5.434	6.212	6.532	6.930	7.258	7.550				
	Operation weight		kg	2.836			3.106	5.169	5.341	5.718	6.522	6.830	7.380	7.708	8.000				
Water heat exchanger	Type	Plate heat exchanger																	
	Water volume		l	49,50					255					307				485	453
	Water flow rate	Cooling	Nom.	l/s	8,8	10,3	11,7	13,5	15,5	18,1	20,9	24	26	29,6	34,3	39,8	45,4		
	Water pressure drop	Cooling	Nom.	kPa	10,6	11	13,4	17,1	21,5	20,4	26,5	33,3	19,8	25	24,2	31,7	29		
Air heat exchanger	Type	Microchannel																	
Compressor	Type	Driven vapour compression																	
	Quantity			1					2										
Fan	Type	Direct propeller																	
	Quantity			8			10	12	14	16	18	20	22	24					
	Air flow rate	Nom.	l/s	29.610			37.013	44.415	51.818	59.220	66.623	74.025	81.428	88.830					
	Speed		rpm	700															
Sound power level (PSB)	Cooling	Nom.	dBA	97,0			98	99			100	101							
Sound power level (PLB)	Cooling	Nom.	dBA	91,0	92	91	92	94					97						
Sound pressure level (PSB)	Cooling	Nom.	dBA	77,0				78	77	78	79								
Sound pressure level (PLB)	Cooling	Nom.	dBA	71,0	72	71	72	73	72	73	75								
Operation range	Air side	Cooling	Min.~Max.	-18~52										-18~55					
	Water side	Cooling	Min.~Max.	-8~18										-15~20					
Refrigerant	Type/GWP	R-134a/1.430																	
	Charge		kg	49	50	51	58	77	86	94	105	114	130	143	156				
	Circuits	Quantity		1					2										
Refrigerant charge	Per circuit		TCO <sub>2</sub> Eq	70,1	71,5	72,9	82,9	55,1	61,5	67,2	75,1	81,5	93,0	102,2	111,5				
Piping connections	Evaporator water inlet/outlet (OD)		mm	88,9			114,3			168,3						219,1			
Unit	Running	Cooling	Nom.	A	101	104	172	177		208	211	346	258	298	316	375	424		
	current	Max	A	126	144	162	188	218	246	285	324	352	436	437	512	577			
Power supply	Phase/Frequency/Voltage		Hz/V	3~/50/400															

# Air cooled screw inverter chiller, premium efficiency, reduced sound



› More information about EWAD-TZPRB

Cooling Only				EWAD-TZPRB	190	220	240	290	300	350	420	495	550	620	720	820	950
Space cooling	A Condition 35°C	Pdc	kW	187,3	218,24	246,75	279,23	317,21	382,29	436,87	505,48	543,03	620,04	717	832,86	949,86	
	ηs,c			%	208,6	212,2	210,6	207	212,2	208,2	210,2	221	218,2	219,8	248,6	249,4	251
SEER				5,29	5,38	5,34	5,25	5,38	5,28	5,33	5,6	5,53	5,57	6,29	6,31	6,35	
Cooling capacity	Nom.		kW	187,3	218,2	246,8	279,2	317,2	382,3	436,9	505,5	543	620	717	833	950	
Power input	Cooling	Nom.	kW	50,48	60,72	68,74	83,42	95,88	105,1	125,3	139,7	151,3	178,5	182,2	220,2	252,4	
Capacity control	Method			Variable													
	Minimum capacity		%	34	29	34	29	27	19	20	17				10		
EER				3,71	3,594	3,59	3,347	3,308	3,637	3,486	3,618	3,59	3,473	3,935	3,783	3,764	
IPLV				6,49	6,35	6,23	6,07	6,04	6,3	6,27	6,47	6,53	6,47	6,73	6,6	6,64	
Dimensions	Unit	Height	mm	2.540													
		Width	mm	2.282													
		Depth	mm	4.131			5.030		5.887	6.786	7.684	8.579	9.480	9.587	10.488	11.387	
Weight	Unit		kg	2.784			3.055		4.907	5.078	5.434	6.212	6.532	6.930	7.258	7.550	
	Operation weight		kg	2.836			3.106		5.169	5.341	5.718	6.522	6.830	7.380	7.708	8.000	
Water heat exchanger	Type			Plate heat exchanger						Shell and tube							
	Water volume		l	49,5						255			307		485		453
	Water flow rate	Cooling	Nom.	9	10,4	11,8	13,3	15,2	18,3	20,9	24,2	26	29,6	34,3	39,8	45,4	
	Water pressure drop	Cooling	Nom.	kPa	10,6	11	13,4	17,1	21,5	20,4	26,4	33,2	19,8	24,9	24,2	31,7	28,9
Air heat exchanger	Type			Microchannel													
Compressor	Type			Driven vapour compression													
	Quantity			1						2							
Fan	Type			Direct propeller													
	Quantity			8			10		12	14	16	18	20		22	24	
	Air flow rate	Nom.	l/s	29.610			37.013		43.369	50.423	57.826	64.879	72.282		79.336	86.738	
	Speed		rpm	700													
Sound power level	Cooling	Nom.	dB(A)	87	88	87	88		89	90		94	95				
Sound pressure level	Cooling	Nom.	dB(A)	67	68	67	68			69		73					
Operation range	Air side	Cooling	Min.~Max.	-18~52						-18~55							
	Water side	Cooling	Min.~Max.	-8~18						-15~20							
Refrigerant	Type/GWP			R-134a/1.430													
	Charge		kg	49	50	51	58	77	86	94	105	114	130	143	156		
	Circuits	Quantity		1						2							
Refrigerant charge	Per circuit		TCO <sub>2</sub> Eq	70,1	71,5	72,9	82,9	55,1	61,5	67,2	75,1	81,5	93,0	102,2	111,5		
Piping connections	Evaporator water inlet/outlet (OD)		mm	88,9			114,3			168,3			219,1				
Unit	Running	Cooling	Nom.	A	101	104	172	177		209	212	347	259	300	317	377	426
	current	Max		A	126	144	162	188	218	246	285	324	352	436	437	512	577
Power supply	Phase/Frequency/Voltage		Hz/V	3~/50/400													

# Air cooled screw inverter chiller, standard efficiency, standard/low sound

- › Optimized energy efficiency both at full and part load conditions
- › Inverter stepless single-screw compressor
- › Advanced compressor technology featuring integrated inverter and variable volume ratio (VVR)
- › HFO R-1234ze Refrigerant with Ozone Depletion Potential equal to zero and extremely low Global Warming Potential
- › Low operating sound levels are achieved by the latest compressor and fan design
- › One or two truly independent refrigerant circuits for outstanding reliability
- › Compact design for small footprint and minimized installation space



› More info about EWAH-TZSSB



› More information about EWAH-TZSLB



Cooling Only				EWAH-TZSSB/SLB																				
				170	200	240	290	330	390	420	490	530	600	690	750	820	920	980	C10					
Space cooling	A Condition 35°C Pdc			kW			170,68	199,73	240,35	293,87	326,19	393,7	421,46	490,52	528,28	598,77	689,86	746,17	820,93	914,93	982,38	1.063,28		
	ηs,c			%			166,8	169,44	179,68	186,68	180,56	181,08	180,56	187,04	186,72	190,68	195,04	197,24	206,92	208,12	205,24	202,2		
SEER				kW			4,245	4,311	4,567	4,742	4,589	4,602	4,589	4,751	4,743	4,842	4,951	5,006	5,248	5,278	5,206	5,13		
Cooling capacity	Nom.			kW			171	200	240	294	326	394	421	491	528	599	690	746	821	915	982	1.063		
Power input	Cooling	Nom.		kW			55,4	69,4	83,3	97,5	115	131	146	170	188	212	244	259	280	321	341	378		
Capacity control	Method			Variable																				
	Minimum capacity			%			33,4	28,6	23,6	18,7	14,3	13,4	11,8	11,2	10									
EER							3,08	2,88	2,89	3,02	2,82	2,99	2,88	2,8	2,82	2,87	2,93	2,85	2,88	2,81				
IPLV							5,19	5,22	5,5	5,73	5,52	5,18	5,16	5,4	5,31	5,41	5,66	5,62	5,72	5,7	5,81	5,86		
Dimensions	Unit	Height	mm			2.540																		
		Width	mm			2.282																		
		Depth	mm			2.331	3.231			5.030			5.887			6.877	7.787	8.687	9.587					
Weight	Unit	kg			2.160,6	2.170,6	2.449,4	2.559,4			4.170,2			4.634	5.619	6.820,8	6.942,8	7.262,2	7.553					
	Operation weight			kg			2.186,7	2.207,95	2.486,75	2.608,9			4.329,2	4.332,2	4.890	4.867	5.867	5.920	7.316,8	7.438,8	7.758,2	8.038	8.006	
Water heat exchanger	Type			Plate heat exchanger																				
	Water volume			l			26	37			50			159	153	256	233	248	301	496			485	453
	Water flow rate	Cooling	Nom.	l/s			8,2	9,5	11,5	14	15,6	18,8	20,1	23,4	25,2	28,6	33	35,6	39,2	43,7	47	50,8		
	Water pressure drop	Cooling	Nom.	kPa			15,1	12,3	17,1	18,2	22	24,4	31,6	33,8	31,1	27,8	34,4	26,3	31,2	38	45,7	34,7		
Air heat exchanger	Type			Microchannel																				
	Compressor			Driven vapour compression																				
Fan	Quantity			1			2																	
	Type			Direct propeller																				
Fan	Quantity			4			6			10			12			14	16	18	20					
	Air flow rate	Nom.		l/s			17.448	26.172			43.620			52.344			61.068	69.792	78.516	87.240				
	Speed			rpm			760																	
Sound power level (SSB)	Cooling	Nom.		dB(A)			97,07	97,53	100,19	101,14	100,59	101,02	103,19	105,6	104,14	104,17	104,19	105,02	106,46	107,18	107,89			
Sound power level (SLB)				dB(A)			91,73	92,13	94,69	96,44	95,32	97,69	99,9	99,44	99,51	99,57	99,46	100,8	101,49	102,16				
Sound pressure level (SSB)	Cooling	Nom.		dB(A)			78,10	78,60	80,7	81,70	80,2	80,60	82,40	84,8	83,40	83,00	82,7	83,50	84,70	85,1	85,80			
Sound pressure level (SLB)				dB(A)			72,78	73,17	75,2	76,96	74,94	75,31	76,92	79,12	78,67	78,39	78,08	77,97	79,01	79,41	80,08			
Operation range	Air side	Cooling	Min.~Max.	°CDB			-18~50																	
	Water side	Cooling	Min.~Max.	°CDB			-8~18																	
Refrigerant	Type/GWP			R-1234(ze)/7																				
	Charge			kg			27,6	41,4			64,2	78	102	116,8	131,2	146								
	Circuits	Quantity		1			2																	
Piping connections	Evaporator water inlet/outlet (OD)			mm			88,9	114,3			139,7	168,3			219,1									
Unit	Running current	Cooling	Nom.	A			93,0	114,0	137,0	158,0	191,0	217,0	243,0	279,0	307,0	343,0	403,0	426,0	457,0	517,0	546,0	602,0		
	Max	A			132,0	156,0	217,0	236,0	272,0	312,0	348,0	434,0	500,0	522,0	606,0	690,0	589,0	661,0	706,0	754,0				
Power supply	Phase/Frequency/Voltage			Hz/V			3~/50/400																	



# Air cooled screw inverter chiller, standard efficiency, reduced sound



EWAH-TZSSB/SLB/SRB

Microtech III



> More information about EWAH-TZSRB



Cooling Only				EWAH-TZSRB																
				170	200	240	290	330	390	420	490	530	600	690	750	820	920	980	C10	
Space cooling	A Condition 35°C	Pdc	kW	170,68	199,73	240,35	293,87	326,19	393,39	421,08	489,94	527,57	597,68	688,98	744,94	819,15	913,23	980,27	1.060,24	
	ηs,c			%	166,8	169,44	179,68	186,68	180,56	180,04	181,36	187,4	185,56	189,6	194,04	195,92	204	206,92	203,36	201,2
SEER				4,245	4,311	4,567	4,742	4,589	4,576	4,609	4,76	4,714	4,815	4,926	4,973	5,175	5,248	5,159	5,105	
Cooling capacity	Nom.		kW	171	200	240	294	326	393	421	490	528	598	689	745	819	913	980	1.060	
Power input	Cooling	Nom.	kW	55,4	69,4	83,3	97,5	115	132	146	171	189	214	245	261	281	323	343	380	
Capacity control	Method			Variable																
	Minimum capacity		%	33,4	28,6	23,6	18,7	14,3	13,4	11,8	11,2	10			10,8	10				
EER				3,08	2,88	2,89	3,02	2,82	2,98	2,87	2,86	2,78	2,79	2,8	2,85	2,91	2,83	2,86	2,79	
IPLV				5,19	5,22	5,5	5,73	5,52	5,13	5,22	5,38	5,29	5,38	5,62	5,6	5,69	5,66	5,79	5,83	
Dimensions	Unit	Height	mm	2.540																
		Width	mm	2.282																
		Depth	mm	2.331	3.231			5.030			5.887			6.877	7.787	8.687	9.587			
Weight	Unit		kg	2.260,6	2.270,6	2.549,4	2.719,4	4.370,2			4.834	5.939		7.140,8	7.262,8	7.582,2	7.873			
	Operation weight		kg	2.286,7	2.307,95	2.586,75	2.768,9	4.529,2	4.523,2	5.090	5.067	6.187	6.240	7.636,8	7.758,8	8.078,2	8.358	8.326		
Water heat exchanger	Type			Plate heat exchanger						Shell and tube										
	Water volume		l	26	37			50	159	153	256	233	248	301	496			485	453	
	Water flow rate	Cooling	Nom.	l/s	8,2	9,5	11,5	14	15,6	18,8	20,1	23,4	25,2	28,6	32,9	35,6	39,1	43,6	46,9	50,7
	Water pressure drop	Cooling	Nom.	kPa	15,1	12,3	17,1	18,2	22	24,4	31,6	33,7	31	27,7	34,3	26,2	31,1	37,8	45,5	34,5
Air heat exchanger	Type			Microchannel																
Compressor	Type			Driven vapour compression																
	Quantity			1					2											
Fan	Type			Direct propeller																
	Quantity			4	6			10	12			14	16	18	20					
	Air flow rate	Nom.	l/s	17.448	26.172			42.600	51.324			59.709	68.433	76.817	85.541					
	Speed		rpm	760																
Sound power level	Cooling	Nom.	dB(A)	87,67	87,93	90,25	92,27	91,42	91,65	93,25	94,9	95,27	95,46	95,6	94,85	95,96	96,53	97,07		
Sound pressure level	Cooling	Nom.	dB(A)	68,70	69,00	70,80	72,80	71,00	71,30	72,50	74,10	74,5	74,30	74,10	73,40	74,20	74,50	75,00		
Operation range	Air side	Cooling	Min.~Max.	°CDB -18~50																
	Water side	Cooling	Min.~Max.	°CDB -8~18																
Refrigerant	Type/GWP			R-1234(ze)/7																
	Charge		kg	27,6	41,4			64,2	78	102	116,8			131,2	146					
	Circuits	Quantity		1					2											
Piping connections	Evaporator water inlet/outlet (OD)		mm	88,9	114,3			139,7	168,3			219,1								
Unit	Running current	Cooling	Nom.	A	93,0	114,0	137,0	158,0	191,0	218,0	244,0	281,0	309,0	345,0	405,0	429,0	459,0	519,0	549,0	604,0
	Max		A	132,0	156,0	217,0	236,0	272,0	312,0	348,0	434,0	500,0	522,0	606,0	690,0	589,0	661,0	706,0	754,0	
Power supply	Phase/Frequency/Voltage		Hz/V	3~/50/400																

# Air cooled screw inverter chiller, high efficiency, standard/low sound

- › High energy efficiency both at full and part load conditions
- › Inverter stepless single-screw compressor with DC electrical motor (for Gold and Platinum efficiency series)
- › Advanced compressor technology featuring integrated inverter and variable volume ratio (VVR)
- › HFO R-1234zeE Refrigerant with Ozone Depletion Potential equal to zero and extremely low Global Warming Potential
- › Compact design for small footprint and minimized installation space
- › Low operating sound levels are achieved by the latest compressor and fan design
- › One or two truly independent refrigerant circuits for outstanding reliability
- › Continuous fans speed modulation thanks to inverter driven fans to improve part load efficiency



› More information about EWAH-TZXSB



› More information about EWAH-TZXLB



Cooling Only				EWAH-TZXSB/XLB																	
				180	220	270	300	350	390	430	480	580	620	670	710	760	820	930	990		
Space cooling	A Condition 35°C	Pdc	kW	180,38	224,67	270,66	300,22	355	392	427,64	481,86	574,38	619,88	672,62	713,55	759,36	825,01	925,8	988,46		
	ηs,c		%	188,68	195,84	194,04	203,08	196,16	196,4	203,28	206,2	214,96	217,88	216,48	220,72	226,8	227,72	227,88	223,6		
SEER				4,792	4,971	4,926	5,152	4,979	4,985	5,157	5,23	5,449	5,522	5,487	5,593	5,745	5,768	5,772	5,665		
Cooling capacity	Nom.		kW	180	225	271	300	355	392	428	482	574	620	673	714	759	825	926	988		
Power input	Cooling	Nom.	kW	51,8	66,3	79	89,6	103	114	125	144	164	181	194	209	224	243	274	307		
Capacity control	Method			Variable																	
	Minimum capacity		%	33,4	26,7	21,6	18,7	16,7	15,4	14,3	12,5	10,8	10				11,7	10			
EER				3,49	3,39	3,43	3,35	3,44	3,42		3,33	3,5	3,41	3,45	3,4	3,38	3,39	3,37	3,22		
IPLV				6,05	6,09	5,92	6,2	5,8	5,81	5,9	6	6,01	6,2	5,99	6,21	6,43	6,32	6,37	6,27		
Dimensions	Unit	Height	mm	2.540																	
		Width	mm	2.282																	
		Depth	mm	3.231	4.131	3.231	4.131	5.887		6.786	7.684	6.877	7.787		8.687	9.587	9.587	11.387			
Weight	Unit		kg	2.447	2.813	2.557	2.923	4.445,2	4.629,2	5.004,6	5.748,6	5.720		6.364,8	7.140,2	7.431	7.879	8.178,2			
	Operation weight		kg	2.484,35	2.862,5	2.606,5	2.972,5	4.598,2	4.870,2	5.237,6	5.981,6	6.021	6.656,8	6.647,8	7.625,2	7.884	8.343	8.631,2			
Water heat exchanger	Type			Plate heat exchanger								Shell and tube									
	Water volume		l	37	50				153	241	233		301	292	283	485	453	464	453		
	Water flow rate	Cooling	Nom.	l/s	8,6	10,7	12,9	14,3	17	18,7	20,4	23	27,4	29,6	32,2	34,1	36,3	39,4	44,2	47,3	
	Water pressure drop	Cooling	Nom.	kPa	10,2	11,2	15,7	18,9	23,2	16,7	34,2	26,3	24,7	31,1	39,8	25,6	57	40,5	27	56,2	
Air heat exchanger	Type			Microchannel																	
Compressor	Type			Driven vapour compressor																	
	Quantity			1								2									
Fan	Type			Direct propeller																	
	Quantity			6	8	6	8	12		14	16	14	16		18	20	22	24			
	Air flow rate	Nom.	l/s	26.172	34.896	26.172	34.896	52.344		61.068	69.792	61.068	69.792		78.516	87.240	95.964	104.688			
	Speed		rpm	760																	
Sound power level (XSB)	Cooling	Nom.	dB(A)	97,19	98,16	101,14	96,57	100,19	100,4	100,7	101,94	99,44	104,19		104,21	104,22	104,34	105,79	106,49		
Sound power level (XLB)			dB(A)	92,14	93,15	96,44	96,57	95,14	95,3	95,68	96,78	99,44	99,57		99,63	99,65	98,92	100,3	100,93		
Sound pressure level (XSB)	Cooling	Nom.	dB(A)	77,7	78,20	81,70	76,60	79,40	79,60		80,40	78,70	82,70		82,40	82,20	82,3	83,20	83,90		
Sound pressure level (XLB)			dB(A)	72,65	73,19	76,96	76,62	74,36	74,53	74,55	75,29		78,67	78,12		77,86	77,6	76,87	77,73	78,36	
Operation range	Air side	Cooling	Min.~Max.	°CDB																	
	Water side	Cooling	Min.~Max.	°CDB																	
Refrigerant	Type/GWP			R-1234(ze)/7																	
	Charge		kg	39	52	39	52	73,2		84,6	97,6	102	116,8		131,2	146	160	175,2			
	Circuits	Quantity		1								2									
Piping connections	Evaporator water inlet/outlet (OD)		mm	88,9	114,3			139,7		168,3								219,1			
Unit	Running current	Cooling	Nom.	A	88,5	113,05	131,55	147,5	176,4	193,47	208,66	243,65	272,5	298,67	327,94	351,57	371,7	400,97	448,69	494,78	
	Max		A	134	173	190	233	266	286	311	372	403	465	483	534	597	568	619	670		
Power supply	Phase/Frequency/Voltage		Hz/V	3~/50/400																	

# Air cooled screw inverter chiller, high efficiency, reduced sound



> More information about EWAH-TZXRB

Cooling Only				EWAH-TZXRB																	
				180	220	270	300	350	390	430	480	580	620	670	710	760	820	930	990		
Space cooling	A Condition 35°C	Pdc	kW	180,38	224,67	270,66	300,22	354,75	391,7	427,42	481,53	573,98	619,32	671,95	712,95	758,61	824,24	924,69	987,05		
			ηs,c	188,68	195,84	194,04	203,08	195,44	195,76	202,72	205,68	213,64	217,16	215,52	219,4	226,04	226,28	227,08	222,8		
SEER				4,792	4,971	4,926	5,152	4,961	4,969	5,143	5,217	5,416	5,504	5,463	5,56	5,726	5,732	5,752	5,645		
Cooling capacity	Nom.		kW	180	225	271	300	355	392	427	482	574	619	672	713	759	824	925	987		
Power input	Cooling	Nom.	kW	51,8	66,3	79	89,6	103	115	125	145	164	182	195	210	225	244	275	308		
Capacity control	Method			Variable																	
	Minimum capacity			%	33,4	26,7	21,6	18,7	16,7	15,4	14,3	12,5	10,8	10			11,7	10			
EER				3,49	3,39	3,43	3,35	3,42	3,41	3,32	3,48	3,39	3,44	3,39	3,36	3,38	3,36	3,2			
IPLV				6,05	6,09	5,92	6,2	5,78	5,77	5,88	5,97	5,98	6,17	5,96	6,16	6,41	6,33	6,34	6,24		
Dimensions	Unit	Height	mm	2.540																	
		Width	mm	2.282																	
		Depth	mm	3.231	4.131	3.231	4.131	5.887		6.786	7.684	6.877	7.787		8.687	9.587		11.387			
Weight	Unit		kg	2.547	2.913	2.717	3.083	4.645,2	4.829,2	5.204,6	5.948,6	6.040	6.684,8		7.460,2	7.751	8.199	8.498,2			
	Operation weight		kg	2.584,35	2.962,5	2.766,5	3.132,5	4.798,2	5.070,2	5.437,6	6.181,6	6.341	6.976,8	6.967,8	7.945,2	8.204	8.663	8.951,2			
Water heat exchanger	Type			Plate heat exchanger																	
	Water volume			l	37	50					153	241	233		301	292	283	485	453	464	453
	Water flow rate	Cooling	Nom.	l/s	8,6	10,7	12,9	14,3	16,9	18,7	20,4	23	27,4	29,6	32,1	34,1	36,3	39,4	44,2	47,2	
Air heat exchanger	Type			Microchannel																	
	Water pressure drop	Cooling	Nom.	kPa	10,2	11,2	15,7	18,9	23,2	16,6	34,1	26,3	24,7	31,1	39,7	25,6	56,9	40,4	26,9	56	
Compressor	Type			Driven vapour compressor																	
	Quantity			1				2													
Fan	Type			Direct propeller																	
	Quantity			6	8	6	8	12		14	16	14	16		18	20	22	24			
	Air flow rate	Nom.	l/s	26.172	34.896	26.172	34.896	51.324		59.709	68.433	59.709	68.433		76.817	85.541	93.925	102.649			
Sound power level	Speed			rpm	760																
	Cooling	Nom.	dB(A)	88,63	89,73	92,27	92,6	91,63	91,73	92,25	93,09	95,27	95,6		95,73	95,8	94,66	95,89	96,34		
Sound pressure level	Cooling	Nom.	dB(A)	69,20	69,80	72,80	72,60	70,90	71,00	71,10	71,6	74,5	74,20		74,00	73,80	72,60	73,30	73,80		
Operation range	Air side	Cooling	Min.~Max.	-18~55																	
	Water side	Cooling	Min.~Max.	-8~18																	
Refrigerant	Type/GWP			R-1234(ze)/7																	
	Charge			kg	39	52	39	52	73,2		84,6	97,6	102	116,8		131,2	146	160	175,2		
Piping connections	Circuits			1				2													
	Quantity																				
Unit	Evaporator water inlet/outlet (OD)			mm	88,9	114,3					139,7	168,3					219,1				
	Running current	Cooling	Nom.	A	88,5	113,05	131,55	147,5	176,9	194,09	209,13	244,1	273,41	299,81	329,23	352,76	373,1	402,29	450,27	496,57	
Power supply	Phase/Frequency/Voltage			Hz/V	3~/50/400																

# Air cooled screw inverter chiller, premium efficiency, standard/low sound

- › Premium energy efficiency both at full and part load conditions
- › Inverter stepless single-screw compressor with DC electrical motor
- › Advanced compressor technology featuring integrated inverter and variable volume ratio (VVR)
- › HFO R-1234zeE Refrigerant with Ozone Depletion Potential equal to zero and extremely low Global Warming Potential
- › Compact design for small footprint and minimized installation space
- › Low operating sound levels are achieved by the latest compressor and fan design
- › One or two truly independent refrigerant circuits for outstanding reliability
- › Continuous fans speed modulation with EC fans for even higher part load efficiency



› More information about EWAH-TZPSB



› More information about EWAH-TZPLB

Cooling Only				EWAH-TZPSB/PLB	370	440	530	610	690	770
Space cooling	A Condition 35°C Pdc			kW	371,15	435,24	532,06	606,43	692,3	778,66
	ηs,c			%	206,56	213,68	220,48	224,96	231,2	232,04
SEER					5,239	5,417	5,587	5,699	5,855	5,876
Cooling capacity	Nom.			kW	371	435	532	606	692	779
Power input	Cooling	Nom.		kW	102	121	137	163	186	217
Capacity control	Method			Variable						
	Minimum capacity			%	16,7	14,3	11,7	10		12,8
EER					3,62	3,58	3,86	3,7	3,72	3,58
IPLV					6,15	6,35	6,36	6,35	6,48	6,63
Dimensions	Unit	Height			mm	2.540				
		Width			mm	2.282				
		Depth			mm	7.684	9.480	7.787	8.687	10.488
Weight	Unit			kg	5.741,4	6.722	6.364,8	7.140,2	7.804,4	8.208,2
	Operation weight			kg	5.982,4	7.023	6.656,8	7.636,2	8.289,4	8.661,2
Water heat exchanger	Type			Shell and tube						
	Water volume			l	241	301	292	496	485	453
	Water flow rate	Cooling	Nom.	l/s	17,7	20,8	25,4	29	33,1	37,2
Air heat exchanger	Type			Microchannel						
	Water pressure drop	Cooling	Nom.	kPa	24,4	15	15,3	18	24,3	19,7
Compressor	Type			Driven vapour compression						
	Quantity			2						
Fan	Type			Direct propeller						
	Quantity				16	20	16	18	22	24
	Air flow rate	Nom.		l/s	69.792	87.240	69.792	78.516	95.964	104.688
Sound power level (PSB)	Speed			rpm	760					
	Cooling	Nom.		dB(A)	100,3	100,8	103,24	104,21	104,24	103,7
	Cooling	Nom.		dB(A)	95,48	96	98,71	99,63	99,73	98,5
Sound pressure level (PSB)	Cooling	Nom.		dB(A)	78,80		81,80	82,40	82,2	81,10
Sound pressure level (PLB)	Cooling	Nom.		dB(A)	74,03	73,96	77,25	77,86	77,68	75,93
Operation range	Air side	Cooling	Min.~Max.	°CDB	-18~-55					
	Water side	Cooling	Min.~Max.	°CDB	-8~-18					
Refrigerant	Type/GWP			R-1234(ze)/7						
	Circuits	Quantity		2						
Refrigerant circuit	Charge			kg	90,4	113	116,8	131,2	160,4	175,2
Piping connections	Evaporator water inlet/outlet (OD)			mm	168,3					
Unit	Running current	Cooling	Nom.	A	175,85	205,4	233,82	272,98	316,97	364,19
	Max			A	272	319	350	424	491	536
Power supply	Phase/Frequency/Voltage			Hz/V	3~/50/400					

# Air cooled screw inverter chiller, premium efficiency, reduced sound



EWAH-TZPSB/PLB/PRB

Microtech III



> More information about EWAH-TZPRB



Cooling Only				EWAH-TZPRB	370	440	530	610	690	770
Space cooling	A Condition 35°C	Pdc	kW	370,96	435,06	531,76	606,09	691,95	778,03	
	ηs,c		%	206,04	213,28	219,28	223,8	229,96	231,24	
SEER				5,226	5,407	5,557	5,67	5,824	5,856	
Cooling capacity	Nom.		kW	371	435	532	606	692	778	
Power input	Cooling	Nom.	kW	102	122	138	164	186	218	
Capacity control	Method			Variable						
	Minimum capacity		%	16,7	14,3	11,7	10		12,8	
EER				3,61	3,57	3,84	3,69	3,7	3,57	
IPLV				6,12		6,32		6,42	6,59	
Dimensions	Unit	Height	mm	2.540						
		Width	mm	2.282						
		Depth	mm	7.684	9.480	7.787	8.687	10.488	11.387	
Weight	Unit		kg	5.941,4	6.922	6.684,8	7.460,2	8.124,4	8.528,2	
	Operation weight		kg	6.182,4	7.223	6.976,8	7.956,2	8.609,4	8.981,2	
Water heat exchanger	Type			Shell and tube						
	Water volume		l	241	301	292	496	485	453	
	Water flow rate	Cooling	Nom.	l/s	17,7	20,8	25,4	28,9	33	37,1
Air heat exchanger	Water pressure drop	Cooling	Nom.	kPa	24,4	14,9	15,3	18	24,2	19,7
	Type			Microchannel						
Compressor	Type			Driven vapour compression						
	Quantity			2						
Fan	Type			Direct propeller						
	Quantity			16	20	16	18	22	24	
	Air flow rate	Nom.	l/s	68.433	85.541	68.433	76.817	93.925	102.649	
	Speed			rpm	760					
Sound power level	Cooling	Nom.	dBA	92,37	92,94	94,94	95,73	95,97	94,72	
Sound pressure level	Cooling	Nom.	dBA	70,90		73,50	74,00	73,90	72,20	
Operation range	Air side	Cooling	Min.~Max.	°CDB		-18~55				
	Water side	Cooling	Min.~Max.	°CDB		-8~18				
Refrigerant	Type/GWP			R-1234(ze)/7						
	Circuits		Quantity	2						
Refrigerant circuit	Charge		kg	90,4	113	116,8	131,2	160,4	175,2	
Piping connections	Evaporator water inlet/outlet (OD)		mm	168,3				219,1		
Unit	Running	Cooling	Nom.	A	176,22	205,83	234,54	273,8	317,85	365,38
	current		Max	A	272	319	350	424	491	536
Power supply	Phase/Frequency/Voltage		Hz/V	3~/50/400						

# Air cooled screw chiller, standard efficiency, standard/low sound

- › Low operating cost and extended operating life thanks to the careful design aimed to optimize the energy efficiency of the chillers and to improve installation profitability, effectiveness and economical management
- › Advanced compressor and fans design that operate at very low sound levels
- › 2 or 3 independent refrigerant circuits for outstanding reliability and maximum safety for maintenance
- › Extremely wide range from 290kW to over 2 MW
- › Optimised for use with R-134a
- › Large operation range (ambient temperature down to -18°C)
- › Units with stepless regulation offer the benefit of following the system energy demand at any time with high efficiency if compared to the units with step regulation. Each unit has infinitely variable capacity control from 100% down to 12,5%
- › The Microchannel technology maximizes the heat exchange ensuring the highest performance with the minimum surface for the exchanger and a reduced quantity of refrigerant compared to Cu/Al condenser.
- › MicroTech III controller with superior control logic and easy interface

› More information about EWAD-T-SSB



› More information about EWAD-T-SLB



Cooling Only				EWAD-T-SSB/SLB		290	330	370	510	520	580	700	800	940	C10	H10	C11	H12	H13	H14	H15	H16	C17	H18	C19	C20	C21																			
Space cooling	A Condition 35°C	Pdc		kW	290,7	334,5	373,4	505,8	522,7	575,8	701,3	809,9	936,3	999,7	1.051	1.135	1.268	1.352	1.456	1.579	1.684	1.762	1.871	1.967	2.065	2.148																				
	η <sub>s,c</sub>			%	149,5	149,6	161,6	161,1	164,6	161,9	161,7	161,3	161,6	162,1	161,9	161,5	162,1	161,7	161,9	162,7	162,1	161,7	161,5	161,6	161,7	161,7																				
SEER					3,8		4,1		4,2		4,1		4,1		4,12		4,14		4,13		4,12		4,11		4,12																					
Cooling capacity	Nom.			kW	290,7	334,5	373,4	505,8	522,7	575,8	701,3	809,9	936,3	999,7	1.051	1.135	1.268	1.352	1.456	1.579	1.684	1.762	1.871	1.967	2.065	2.148																				
Power input	Cooling	Nom.		kW	92,73	111,6	120,8	166,6	171	189,6	234,1	266,1	308,3	340,7	362,4	387,9	438,8	464,4	490,7	534	563	605,3	654,1	682,5	710	735,3																				
Capacity control	Method				Fixed												Stepless																													
	Minimum capacity			%	12,5												8,3																													
EER					3,135	2,996	3,09	3,037	3,057	3,036	2,996	3,043	3,037	2,934	2,903	2,928	2,89	2,913	2,969	2,956	2,992	2,912	2,861	2,882	2,908	2,922																				
IPLV					4,48	4,38	4,37	4,83	5,38	5,49	4,93	4,55	4,69	4,61	4,41	4,46	4,5	4,53	4,58	4,61	4,54	4,45	4,46	4,4	4,53																					
Dimensions	Unit	Height		mm	2.537																																									
		Width		mm	2.258												2.282																													
		Depth		mm	3.230	4.130	5.030	5.976	6.876	7.776	8.676	9.576	10.509	11.409	12.309	13.209	14.109																													
Weight	Unit			kg	3.061	4.104	4.724	4.860	5.527	5.525	5.858	6.229	6.520	6.780	8.084	8.426	9.938	10.575	10.636	10.902	11.202	11.422																								
	Operation weight			kg	3.161	4.274	4.894	5.030	5.825	6.188	6.710	6.981	7.272	8.554	8.887	10.460	11.446	11.589	11.855	12.237	12.457																									
Water heat exchanger	Type				Shell and tube																																									
	Water volume			l	89	181	164	170	164	298	300	330	481	461	492	470	461	522	871	953	1.035																									
	Water flow rate	Cooling	Nom.	l/s	13,9	16	17,9	24,2	25	27,6	33,6	38,7	44,8	47,8	50,3	54,3	60,7	64,7	69,8	75,5	80,6	84,4	89,6	94,2	98,9	102,9																				
	Water pressure drop	Cooling	Nom.	kPa	28,5	31,1	42	30,5	43,6	60,4	51,4	32,4	39,5	44,7	41,6	32,7	34,2	44,5	61,3	43,8	49,3	53,5	56,4	64,5	64,8	69,6																				
Air heat exchanger	Type				Microchannel																																									
Compressor	Type				Driven vapour compression																																									
	Quantity				2												3																													
Fan	Type				Direct propeller, on/off fans																																									
	Quantity				6	8	10	12	14	16	18	20	22	24	26	28	30																													
	Air flow rate	Nom.		l/s	33.129	44.172	55.214	66.257	77.300	88.343	99.386	110.429	121.472	132.515	143.557	154.600	165.643																													
	Speed			rpm	900																																									
Sound power level (SSB)	Cooling	Nom.		dBA	98	101				102				103				100																												
Sound power level (SLB)	Cooling	Nom.		dBA	94	95	97	96	97	98	97	98				80																														
Sound pressure level (SSB)	Cooling	Nom.		dBA	78	81				83				84				80																												
Sound pressure level (SLB)	Cooling	Nom.		dBA	74	75	77	79	80				79				77																													
Operation range	Air side	Cooling	Min.~Max.	°CDB	-18~50																																									
	Water side	Cooling	Min.~Max.	°CDB	-8~18																																									
Refrigerant	Type/GWP				R-134a/1.430																																									
	Charge			kg	50	55	58	66	67	93,6	109,2				124,8				140,4				156				172				187				203				218				234			
	Circuits	Quantity			2																																									
					3																																									
Refrigerant charge	Per circuit			TCO <sub>2</sub> Eq	35,75	39,32	41,47	47,19	47,90	66,92	78,08				89,23				100,39				111,54				81,99				88,14				96,76				103,91				111,54			
Piping connections	Evaporator water inlet/outlet (OD)			mm	114,3	139,7				168,3				219,1				273																												
Unit	Starting current	Max		A	253	264	306	470	493	574	645	697	705	773	797	877	925	933	1.161	1.217	1.270	1.324																								
	Running current	Cooling	Nom.	A	76,76	94,25	195,63	144,71	148,11	171,97	370,76	422,34	486,54	534,13	572,46	610	692,46	727,9	763,34	839	885	951	1.029	1.073	1.118	1.158																				
	current	Max		A	211	242	272	345,00	373	395	492	536	621	675	709	768	838	897	956	986	1.118	1.188	1.257	1.323	1.389	1.455																				
Power supply	Phase/Frequency/Voltage			Hz/V	3~/50/400																																									

# Air cooled screw chiller, standard efficiency, reduced sound



› More information about EWAD-T-SRB



Cooling Only				EWAD-T-SRB																	
				700	800	940	C10	H10	C11	H12	H13	H14	H15	H16	C17	H18	C19	C20	C21		
Space cooling	A Condition 35°C	PdC	kW	684,7	786,9	909	967,5	1.014	1.099	1.216	1.302	1.408	1.525	1.632	1.702	1.798	1.894	1.992	2.077		
	η <sub>s,c</sub>		%	161,3	161,1	161,0	161,2	161,3	161,1	161,2	161,0	161,9	161,3	161,3	4,12	4,11	161,1	160,9	161,1	161,2	
SEER				4,1												4,1					
Cooling capacity	Nom.			kW	684,7	786,9	909	967,5	1.014	1.099	1.216	1.302	1.408	1.525	1.632	1.702	1.798	1.894	1.992	2.077	
Power input	Cooling	Nom.			kW	236,6	270,7	314,8	351,1	373	398	453,8	478,7	504,2	547,5	575,4	622,1	675,9	703,7	730,9	755,5
Capacity control	Method			Fixed												Stepless					
	Minimum capacity			12,5												8,3					
EER				2,894	2,907	2,89	2,755	2,719	2,762	2,681	2,722	2,793	2,785	2,837	2,736	2,66	2,691	2,725	2,75		
IPLV				4,9	4,56	4,57	4,45	4,39	4,44	4,43	4,49	4,6	4,62	4,54	4,44	4,46	4,4	4,53			
Dimensions	Unit	Height	mm	2.537																	
		Width	mm	2.282																	
		Depth	mm	5.976	6.876			7.776			8.676	9.576	10.509	11.409		12.309	13.209	14.109			
Weight	Unit			kg	5.527	5.525	5.858	6.229	6.520	6.780	8.084	8.426	10.588	11.225		11.286	11.552	11.852	12.072		
	Operation weight			kg	5.825		6.188	6.710	6.981	7.272	8.554	8.887	11.110	12.096		12.239	12.505	12.887	13.107		
Water heat exchanger	Type			Shell and tube																	
	Water volume			l	298	300	330	481	461	492	470	461	522	871		953		1.035			
	Water flow rate	Cooling	Nom.	l/s	32,8	37,6	43,5	46,3	48,5	52,6	58,2	62,3	67,4	73	78,1	81,5	86,1	90,7	95,4	99,5	
Air heat exchanger	Water pressure drop	Cooling	Nom.	kPa	49,2	30,7	37,5	42,2	39	30,8	31,7	41,6	57,7	41,1	46,5	50,2	52,5	60,2	60,7	65,5	
	Type			Microchannel																	
Compressor	Type			Driven vapour compression																	
	Quantity			2												3					
Fan	Type			Direct propeller, on/off fans																	
	Quantity			12	14			16	18	20	22	24		26	28	30					
	Air flow rate	Nom.	l/s	52.172	60.868			69.563	78.258	86.954	95.649	104.344		113.040	121.735	130.431					
	Speed			760												700					
Sound power level	Cooling	Nom.	dB(A)	91			92			93		95		96							
Sound pressure level	Cooling	Nom.	dB(A)	73	74	73	74			72		73									
Operation range	Air side	Cooling	Min.~Max.	°CDB	-18~46												-18~50				
	Water side	Cooling	Min.~Max.	°CDB	-8~18																
Refrigerant	Type/GWP			R-134a/1.430																	
	Charge			kg	93,6	109,2			124,8		140,4	156	172	187		203	218	234			
	Circuits	Quantity			2												3				
Refrigerant charge	Per circuit			TCO <sub>Eq</sub>	66,92	78,08			89,23		100,39	111,54	81,99	89,14		96,76	103,91	111,54			
Piping connections	Evaporator water inlet/outlet (OD)			mm	168,3			219,1			273										
Unit	Starting current	Max	A	567	638	693	701	766	786	868	914	922	1.057	1.143	1.199	1.250	1.301				
	Running current	Cooling	Nom.	A	376,73	431,76	499,71	554,32	592,7	629,99	720,93	755,84	790,74	864	909	984	1.070	1.115	1.161	1.201	
	current	Max	A	478	523	605	659	693	750	820	876	933	961	1.091	1.160	1.230	1.293	1.357	1.420		
Power supply	Phase/Frequency/Voltage			Hz/V	3~/50/400																

# Air cooled screw chiller, high efficiency, standard/low sound

- › Low operating cost and extended operating life thanks to the careful design aimed to optimize the energy efficiency of the chillers and to improve installation profitability, effectiveness and economical management
- › Advanced compressor and fans design that operate at very low sound levels
- › 2 or 3 independent refrigerant circuits for outstanding reliability and maximum safety for maintenance
- › Extremely wide range from 290kW to over 2 MW
- › Optimised for use with R-134a
- › Large operation range (ambient temperature down to -18°C)
- › Units with stepless regulation offer the benefit of following the system energy demand at any time with high efficiency if compared to the units with step regulation. Each unit has infinitely variable capacity control from 100% down to 12,5%
- › The Microchannel technology maximizes the heat exchange ensuring the highest performance with the minimum surface for the exchanger and a reduced quantity of refrigerant compared to Cu/Al condenser.
- › MicroTech III controller with superior control logic and easy interface

› More information about EWAD-T-XSB



› More information about EWAD-T-XLB



Cooling Only				EWAD-T-XSB/XLB																							
				350	380	400	420	440	490	540	570	730	820	950	C10	H10	H11	C13	H13	C14	H15	H16	C17	18	C19	C20	
Space cooling	A Condition 35°C	PdC	kW	351,5	376,9	398,3	415,2	437,9	491,7	541,2	564,8	725,4	831,9	943,5	1.008	1.077	1.164	1.308	1.390	1.454	1.606	1.705	1.836	1.952	2.027	2.088	
	ηs,c			%	154,6	155,1	162,1	161,2	161,1	168,0	171,7	168,0	167,1	164,5	169,6	166,3	166,7	167,1	166,7	164,7	164,8	164,8	163,7	164,9	168,1	166,8	167,0
SEER				3,9	4,0	4,1	4,1	4,3	4,4	4,3	4,2	4,3	4,2	4,3	4,2	4,3	4,2	4,3	4,2	4,1,9	4,1,7	4,2,0	4,2,8	4,2,4	4,2,5		
Cooling capacity	Nom.		kW	351,5	376,9	398,3	415,2	437,9	491,7	541,2	564,8	725,4	831,9	943,5	1.008	1.077	1.164	1.308	1.390	1.454	1.606	1.705	1.836	1.952	2.027	2.088	
Power input	Cooling	Nom.	kW	106,1	114,9	121,4	128,8	138,5	159,1	166,6	177,8	234,6	267,5	299,3	333,1	347,2	374,7	421,1	447,1	481,7	520,7	552,3	589,3	624,4	662,6	699	
Capacity control	Method			Fixed																Stepless							
	Minimum capacity		%	12,5																8,3							
EER				3,314	3,28	3,224	3,163	3,091	3,248	3,177	3,092	3,11	3,152	3,027	3,103	3,108	3,107	3,109	3,019	3,085	3,088	3,115	3,126	3,059	2,987		
IPLV				4,6	4,55	4,76	4,61	4,57	5,46	5,49	5,3	4,93	4,65	5,17	4,69	4,63	4,66	4,64	4,68	4,63	4,5	4,51	4,55	4,56	4,53	4,48	
Dimensions	Unit	Height	mm	2.537																							
		Width	mm	2.258						2.282																	
		Depth	mm	4.130	5.030				5.878	5.976	7.776	8.676	9.576	10.476	11.409	12.309	13.209	14.109									
Weight	Unit		kg	4.054	4.064	4.360		4.860	5.397	5.387	5.315	5.525	6.121		7.798	8.126	8.386	8.751	8.765	10.575	10.841	10.711	10.931	11.451			
		Operation weight	kg	4.224	4.234	4.530		5.030	5.567	5.557	5.604	5.825	6.451		8.259	8.587	8.878	9.232	9.235	11.446	11.712	11.233	11.453	12.461			
Water heat exchanger	Type			Shell and tube																							
		Water volume	l	134	129			170			164	170	289	300	330		461	492	481	470	871	522		1.010			
		Water flow rate	l/s	16,8	18	19	19,8	20,9	23,5	25,9	27	34,7	39,8	45,1		48,3	51,6	55,8	62,6	66,5	69,6	76,9	81,6	87,9	93,5	97,1	100
			kPa	20,1	26,3	25,1	19,3	21,1	42,7	34,1	33,4	33	36,8	40,8	46	51,9	60,5	36,2	40,4	50,8	45,2	50,4	54,5	63,6	62,7	66,1	
Air heat exchanger	Type			Microchannel																							
Compressor	Type			Driven vapour compression																							
	Quantity			2																3							
Fan	Type			Direct propeller, on/off fans																							
	Quantity			8				10				12				16		18	20	22		24	26	28	30		
	Air flow rate	Nom.	l/s	44.172				55.214				66.257				88.343		99.386	110.429		121.472		132.515	143.557	154.600	165.643	
	Speed	rpm	900																								
Sound power level (XSB)	Cooling	Nom.	dBA	98				101				99				100		101		103							
Sound power level (XLB)				95				97				98				99				100				98	99		
Sound pressure level(XSB)	Cooling	Nom.	dBA	78				81				82				81	82	81	82		80		79		80		
Sound pressure level(XLB)				75				77				79	80	79	80	79	80	79	77								
Operation range	Air side	Cooling	Min.~Max.	-18~53																							
	Water side	Cooling	Min.~Max.	-8~-18																							
Refrigerant	Type/GWP			R-134a/1.430																							
	Charge		kg	52	54	65	66				72	93,6	124,8		140,4	156	171,6		187	203	218	234					
	Circuits	Quantity		2																3							
Refrigerant charge	Per circuit		TCO,Eq	37,18	38,61	46,48	47,19				51,48	66,92	89,23		100,39	111,54	122,69		89,14	96,76	103,91	111,54					
Piping connections	Evaporator water inlet/outlet (OD)		mm	139,7								168,3								219,1				273			
Unit	Starting current	Max	A	253	296	311	399	422	475	493	574	645	703	705	778	802	883	931	939	1.075	1.166	1.227		1.276	1.324		
	Running current	Cooling	Nom.	A	174,38	97,83	114,97	114,79	129,16	147,79	141,98	158,14	372,87	424,09	471,71	521	546,1	584,5	662,5	699,2	749,6	818	867	924	978	1.040	1.099
		Max	A	248	260	277	299	322,00	351	378	401	492	536	626	680	719	778	848	907	961	991	1.123	1.198	1.273	1.333	1.394	
Power supply	Phase/Frequency/Voltage		Hz/V	3~/50/400																							



# Air cooled screw chiller, high efficiency, reduced sound



› More information about EWAD-T-XRB

Cooling Only				EWAD-T-XRB	730	820	950	C10	H10	H11	C13	H13	C14	H15	H16	C17	H18	C19	C20																		
Space cooling	A Condition 35°C	Pdc	kW	707,6	807,8	922,1	982,4	1.053	1.164,0	1.273	1.355	1.412,0	1.563	1.661	1.789	1.903	1.970	2.024																			
	ηs,c			%	165,4	163,9	167,5	165,1	165,4	166,3	165,9	165,5	163,8	164,3	163,3	164,5	166,488	165,13	165,732																		
SEER				4,2		4,3		4,2				4,18		4,16		4,19		4,24		4,22																	
Cooling capacity	Nom.		kW	707,6	807,8	922,1	982,4	1.053	1.164	1.273	1.355	1.412	1.563	1.661	1.789	1.903	1.970	2.024																			
Power input	Cooling	Nom.	kW	237,3	272,1	301,1	338,9	348	374,7	426,4	452	490,7	528,7	559,8	596,8	631,7	674,4	714,9																			
Capacity control	Method			Fixed								Stepless																									
	Minimum capacity		%	12,5								8,3																									
EER				2,982	2,968	3,063	2,898	3,018	3,108	2,986	2,998	2,879	2,956	2,968	2,997	3,013	2,921	2,831																			
IPLV				4,92	4,56	5,1	4,57	4,65	4,67	4,65	4,69	4,62	4,51	4,53	4,56	4,57	4,54	4,48																			
Dimensions	Unit	Height	mm	2.537																																	
		Width	mm	2.282																																	
		Depth	mm	5.976				7.776				8.676				9.576				10.476				11.409				12.309				13.209				14.109	
Weight	Unit		kg	5.315	5.525	6.121	7.798	8.126	8.386	8.751	8.765	11.225	11.491	11.361	11.581	12.101																					
	Operation weight		kg	5.604	5.825	6.451	8.259	8.587	8.878	9.232	9.235	12.096	12.362	11.883	12.103	13.111																					
Water heat exchanger	Type			Shell and tube																																	
	Water volume		l	289	300	330	461	470	871	522	1.010																										
	Water flow rate	Cooling	Nom.	l/s	33,8	38,6	44,1	47	50,4	55,8	60,9	64,8	67,6	74,8	79,5	85,6	91,1	94,3	96,9																		
	Water pressure drop	Cooling	Nom.	kPa	31,6	34,9	39,2	43,9	49,8	60,5	34,4	38,5	48,2	43	48,1	52	60,8	59,5	62,5																		
Air heat exchanger	Type			Microchannel																																	
Compressor	Type			Driven vapour compression																																	
	Quantity			2								3																									
Fan	Type			Direct propeller, on/off fans																																	
	Quantity			12	16	18	20	22	24	26	28	30																									
	Air flow rate	Nom.	l/s	52.172	69.563	78.258	110.429	86.954	95.649	104.344	113.040	121.735	130.431																								
	Speed		rpm	760				900				760				700																					
Sound power level	Cooling	Nom.	dB(A)	91				92				93				97				98																	
Sound pressure level	Cooling	Nom.	dB(A)	73	74	73	74	73				74				75				74																	
Operation range	Air side	Cooling	Min.~Max.	°CDB																																	
	Water side	Cooling	Min.~Max.	°CDB																																	
Refrigerant	Type/GWP			R-134a/1.430																																	
	Charge		kg	93,6	124,8	140,4	156	171,6	187	203	218	234																									
	Circuits	Quantity		2								3																									
Refrigerant charge	Per circuit		TCO <sub>2</sub> Eq	66,92	89,23	100,39	111,54	122,69	89,14	96,76	103,91	111,54																									
Piping connections	Evaporator water inlet/outlet (OD)		mm	168,3								219,1								273																	
Unit	Starting current	Max	A	567	638	696	701	769	802	871	917	925	1.057	1.146	1.204	1.253	1.301																				
	Running current	Cooling	Nom.	A	379,04	433,58	477,39	533,75	552,3	584,5	675,01	711,6	769,5	834	883	941	995	1.067	1.134																		
		Max	A	478	523	608	662	699	778	826	882	936	964	1.093	1.166	1.239	1.299	1.360																			
Power supply	Phase/Frequency/Voltage		Hz/V	3~/50/400																																	

# Why choose EWAT-B- chiller series?



## **R-32**

- ✓ Top class efficiency, SEER up to 4,7.  
Overcoming 2021 Eco-design requirements!
- ✓ Environmental friendly refrigerant  
→ First in the market
- ✓ New R-32 optimized scroll compressors and heat exchangers
- ✓ The Global Warming Potential (GWP) of R-32 refrigerant is 675, which is only one third compared to commonly used refrigerant R-410
- ✓ The low GWP R-32 refrigerant falls into category class A2L in ISO817 and it can be safely used in many applications including chilled water systems
- ✓ As a single component refrigerant, R-32 is also easier to recycle and reuse another environmental plus in its favour
- ✓ Wide capacity range: 80 – 700 kW
- ✓ Microchannel condensing coil, for reduced refrigerant charge
- ✓ Silver and Gold efficiency versions
- ✓ 3 sound configurations
- ✓ Full compatibility with Daikin on Site
- ✓ New Hydronic Kit configurations (single and twin pump, inertial tank, VFD)
- ✓ Single and dual circuit version overlapping between 150 kW and 350 kW
  - › Single circuit units fits 2 or 3 compressors
  - › Dual circuit units fits 4 or 5 or 6 compressors
- ✓ Extensive option lists
- ✓ Fan speed modulation option (VFD)

# Two different layouts



## Single-V Layout

- > Slim layout
- > Higher flexibility: new intermediate sound configuration for both Silver and Gold versions



## Modular-V Layout:

- > Brand new layout
- > Better part load efficiency (SEER) vs previous generation:
  - > +4% with standard arrangement
  - > +7% with VFD fan option

# Extensive option lists

# Including new options:

## **NEW** Partial heat recovery

Introduction of condensation control allowing to maintain heat recovery capacity at lower ambient temperatures with unit operating at full capacity

	HR @ 35°C ambient	HR @ 20°C ambient
Current	~ 15%	~ 3%
New	~ 15%	~ 15%

## **NEW** Buffer tank

Unit mounted buffer tank available all across the range for plug and play solution.

## **NEW** VFD pumps and variable flow control

- > Variable pump speed control via external 0-10 volt signal
- > "Thermostat on" and "thermostat off" pump speed management
- > Variable primary flow control

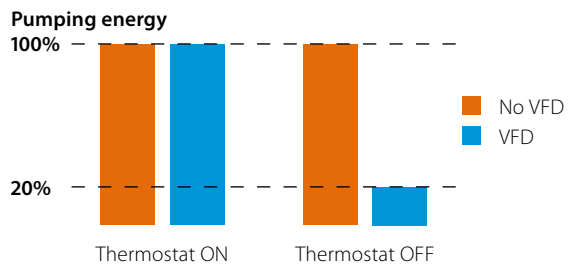

## Master/Slave supplied as standard

Master/Slave functionality allowing to manage up to 4 units on the same system without the need of external control devices.

## Fan Silent Mode

The single V units and units with VFD option are standardly equipped with Fan Silent Mode, which reduces fan velocity and therefore unit sound emission on scheduled time bands, enhancing comfort during night operation

# New free-cooling options

## What is free-cooling?

It's the capability of a system/equipment to cool air or water by taking advantage of the **favourable outdoor conditions** when ambient temperature is reducing, for example during winter or intermediate seasons or even during night time operation

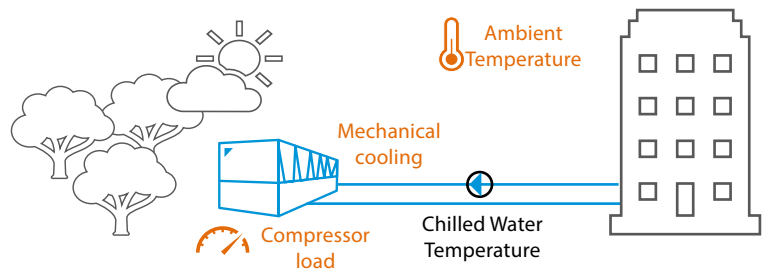

Free-cooling operation allows to **reduce the power consumption** generated by traditional mechanical cooling (e.g. Compressors).

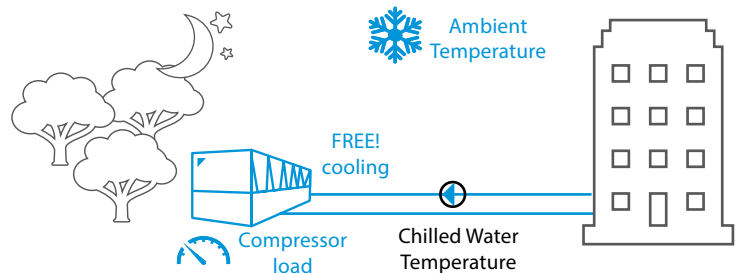

## Why free-cooling?

The use of the outdoor ambient as a source for cooling is the perfect way to answer to the new "**EPBD Directive**" (Energy Performance of Buildings Directive):

All new buildings in the European Union shall be **nZEB (nearly Zero Energy Buildings)** from 31/12/2020 and public buildings shall lead the way and be nZEB compliant **from 31/12/2018**. From **2021** this will apply also to private buildings.

# BLUEEVOLUTION +



The new Daikin R-32 chiller series can be offered with innovative free-cooling options to further improve energy efficiency and reduce running costs.



## Free-cooling - Light (glycol free)

Refrigerant migration system allowing to recover up to 25% of nominal unit capacity

### Benefits

- › Glycol free solution
- › No refrigerant pump required
- › No extra footprint vs standard unit
- › No extra pressure drops on water side

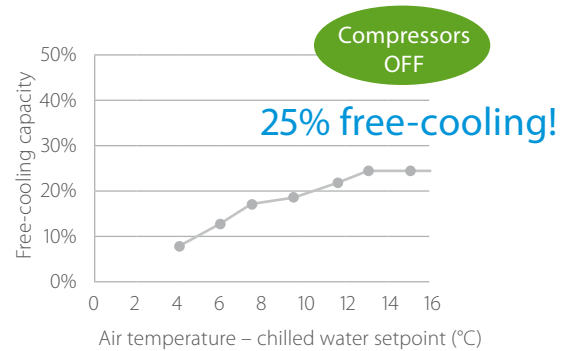

## Free-cooling - Full (glycol free)



Refrigerant migration system allowing to recover up to 75% of nominal unit capacity.

### Benefits

- › 75% free-cooling due to additional "Shell & Tube" refrigerant to water exchanger (compared to Light version)
- › Glycol free solution
- › No refrigerant pump required
- › No extra footprint vs standard unit\*
- › No extra pressure drops on water side

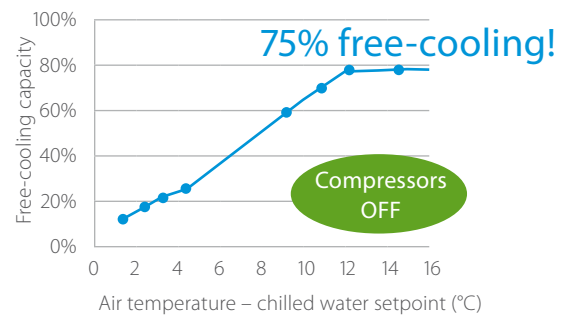

(\*) except 4 fans models

# Connectivity

## mAP

- › Android app
- › Replicate the controller of the unit
- › Operate on the unit by remote smart device (tablet, smartphone, PC)
- › Soon available on PlayStore



## Portable touch screen option

- › Display 10"
- › Touch screen
- › Network: Wireless, Bluetooth, GPS, GSM, ecc...
- › Interface: SIM card, RJ45, RS232, USB, HDMI, audio

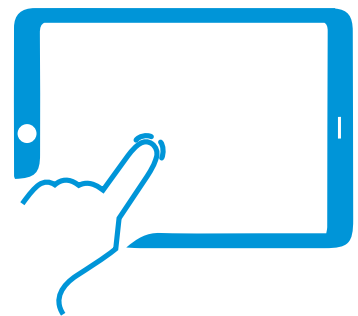

## Daikin on Site

Fully compatible with Daikin on Site cloud based platform that allows a number of advanced functionalities including:

- › Remote monitoring,
- › System optimization
- › Preventive maintenance

Remote access with one click via LAN or GSM modem



## Connection to Intelligent Chiller Manager

In case of more complex installations Daikin can offer the Intelligent Chiller Manager option, allowing energy optimisation of the system and, when necessary, full customization of the control solutions to the specific installation's needs

- › High number of units
- › Peripheral controls



# Air cooled scroll chiller, standard efficiency, standard/low sound

- › First R-32 air cooled chiller with Scroll compressors in the market
- › Choosing for an R-32 product, reduces the environmental impact with 68% compared to R-410A and leads directly to lower energy consumption thanks to its high energy efficiency
- › One or two truly independent refrigerant circuits for outstanding reliability
- › MicroTech III controller with superior control logic and easy interface
- › Low operating cost and extended operating life thanks to the careful design aimed to optimize the energy efficiency of the chillers and to improve installation profitability, effectiveness and economical management

- › Fan speed modulation to ensure precise airflow control and optimized condensing temperature
- › Possible to set up detailed time bands to reduce fan rotation speed and therefore sound emission
- › Thanks to the Dynamic Condensing Pressure Management, the chiller controller adjusts the condensing pressure set-point to minimize the overall chiller power input

› More information about EWAT-B-SS



› More information about EWAT-B-SL

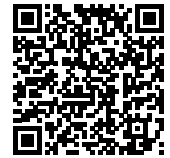

Cooling Only				EWAT-B-SS/SL																										
				085	115	135	155	175	195	205	215	240	260	290	310	330	340	350	420	460	510	570	610	670						
Space cooling	A Condition 35°C Pdc			kW																										
	ηs,c			%																										
	ηs,c + VFDFAN			%																										
SEER				3,8	4,12	3,8	3,8	4,15	4,02	4,07	3,85	4,21	3,96	4,28	4,23	4,26	4,32	4,11	4,44	4,35	4,38	4,32	4,36	4,36						
SEER + VFDFAN				-																										
Cooling capacity				kW																										
Power input				kW																										
Capacity control				%																										
EER				-																										
IPLV				-																										
EER + VFDFAN				-																										
IPLV + VFDFAN				-																										
Dimensions				mm																										
Weight (SS)				kg																										
Water heat exchanger				kPa																										
Air heat exchanger				°CDB																										
Compressor				-																										
Fan				rpm																										
Sound power level (SS)				dB(A)																										
Sound power level (SL)				dB(A)																										
Sound pressure level (SS)				dB(A)																										
Sound Pressure (SL)				dB(A)																										
Operation range				°CDB																										
Refrigerant				kg																										
Piping connections				mm																										
Unit				A																										
Power supply				Hz/V																										



# Air cooled scroll chiller, standard efficiency, reduced sound



Single V

EWAT-B-SS/SL/SR Modular V

Microtech III



> More information about EWAT-B-SR

Cooling Only				EWAT-B-SR																																									
Space cooling				kW																																									
ηs,c				%																																									
SEER				3,8 4,11 3,8 3,8 4,17 3,9 3,92 3,82 4,29 4,01 4,26 4,2 4,26 4,4 4,04 4,42 4,35 4,41 4,3 4,37 4,41																																									
Cooling capacity				kW																																									
Power input				kW																																									
Capacity control				Variable																																									
EER				2,26 2,6 2,33 2,27 2,26 2,47 2,36 2,21 2,59 2,48 2,3 2,44 2,41 2,69 2,35 2,7 2,43 2,46 2,31 2,35 2,53																																									
IPLV				4,67 4,97 4,5 4,63 4,74 4,62 4,72 4,36 4,88 4,63 4,84 4,83 4,72 5,01 4,7 4,81 4,86 4,75 4,84 4,84 4,89																																									
Dimensions				mm																																									
Weight				kg																																									
Water heat exchanger				Brazed plate																																									
Air heat exchanger				Microchannel																																									
Compressor				Driven vapour compression																																									
Fan				Direct propeller																																									
Sound power level				dB(A)																																									
Sound pressure level				dB(A)																																									
Operation range				°CDB																																									
Refrigerant				R-32/675																																									
Piping connections				mm																																									
Unit				A																																									
Power supply				Hz/V																																									
A Condition 35°C Pdc				76,32	104,78	123,67	149,61	164,58	180,89	199,92	203,05	230,33	247,63	265,52	289,52	310,75	328,17	329,79	397,33	441,96	486,05	532,44	576,51	634,99	149	161,4	149	149	163,8	153	153,8	149,8	168,6	157,4	167,4	165	167,4	173	158,6	173,8	171	173,4	169	171,8	173,4
Nom.				3,8	4,11	3,8	3,8	4,17	3,9	3,92	3,82	4,29	4,01	4,26	4,2	4,26	4,4	4,04	4,42	4,35	4,41	4,3	4,37	4,41	50	38	50	25	38	21	19	50	17	25	24	14	13	33	19	17	15	14	12	11	17
Cooling				33,8	40,3	53,1	65,9	72,8	73,2	84,7	91,9	89,1	100	115	118	129	122	140	147	181	197	230	244	251	Variable																				
Method				Staged			Variable			Staged			Variable			Staged			Variable																										
Minimum capacity				%																																									
Unit				mm																																									
Height				1.801																																									
Width				1.822																																									
Depth				1.204																																									
Unit				kg																																									
Operation weight				kg																																									
Type				Brazed plate																																									
Water volume				l																																									
Water flow rate				l/s																																									
Water pressure drop				kPa																																									
Type				Microchannel																																									
Type				Driven vapour compression																																									
Quantity				2 4 2 4 2 4 3 4 3 4 5 6																																									
Type				Direct propeller																																									
Quantity				4 6 8 10 4 5 6 5 7 8 9 11																																									
Air flow rate				l/s																																									
Speed				rpm																																									
Cooling				dB(A)																																									
Cooling				dB(A)																																									
Air side				°CDB																																									
Water side				°CDB																																									
Type/GWP				R-32/675																																									
Charge				kg																																									
Circuits				Quantity																																									
Evaporator water inlet/outlet (OD)				mm																																									
Starting current				A																																									
Running current				A																																									
Phase/Frequency/Voltage				Hz/V																																									

# Air cooled scroll chiller, high efficiency, standard/low sound

- › First R-32 air cooled chiller with Scroll compressors in the market
- › Choosing for an R-32 product, reduces the environmental impact with 68% compared to R-410A and leads directly to lower energy consumption thanks to its high energy efficiency
- › One or two truly independent refrigerant circuits for outstanding reliability
- › MicroTech III controller with superior control logic and easy interface
- › Low operating cost and extended operating life thanks to the careful design aimed to optimize the energy efficiency of the chillers and to improve installation profitability, effectiveness and economical management

- › Fan speed modulation to ensure precise airflow control and optimized condensing temperature
- › Possible to set up detailed time bands to reduce fan rotation speed and therefore sound emission
- › Thanks to the Dynamic Condensing Pressure Management, the chiller controller adjusts the condensing pressure set-point to minimize the overall chiller power input

› More information about EWAT-B-XS



› More information about EWAT-B-XL



Cooling Only				EWAT-B-XS/XL																											
				085	115	145	180	185	200	220	230	250	280	300	310	320	360	370	430	470	540	600	660	700							
Space cooling	A Condition 35°C Pdc			kW																											
	ηs,c			%																											
	ηs,c + VFDFAN			%																											
SEER				3,96 4,37 4,21 4,11 4,31 4,18 4,25 4,21 4,27 4,4 4,34 4,42 4,36 4,37 4,35 4,47 4,36 4,42 4,42 4,47 4,36 4,42 4,42 4,47 4,46																											
SEER + VFDFAN				- 4,29 - 4,35 4,4 4,33 4,44 4,58 4,68 4,56 4,42 4,6 4,45 4,58 4,45 4,67 4,68 4,72 4,74																											
Cooling capacity				Nom. kW																											
Power input				Cooling Nom. kW																											
Capacity control				Method Staged Variable Staged Variable Staged Variable																											
EER				Minimum capacity %																											
IPLV				3,04 3,11 3,22 3,12 2,86 3,05 3,01 3,19 3,11 3,19 3,11 3,12 3,05 3,1 3,05 3,11 3,08 3,06 3,1 3,12 3,08																											
EER + VFDFAN				- 3,11 - 3,04 3,01 3,18 3,1 3,17 3,1 3,12 3,04 3,1 3,04 3,1 3,07 3,05 3,1 3,11 3,07																											
IPLV + VFDFAN				- 5,11 - 5,05 5,01 4,92 4,97 5,12 5,09 4,92 4,86 4,94 4,96 4,94 4,99 5,01 4,99 5,12 5,08																											
Dimensions				Unit Height mm Width mm Depth mm																											
Weight (XS)				Unit Operation weight kg																											
Water heat exchanger				Type Brazed plate																											
Air heat exchanger				Type Microchannel																											
Compressor				Type Driven vapour compression																											
Fan				Type Direct propeller																											
Sound power level (XS)				Cooling Nom. dBA																											
Sound power level (XL)				Cooling Nom. dBA																											
Sound Pressure (XL)				Cooling Nom. dBA																											
Operation range				Air side Cooling Min.~Max. °CDB Water side Cooling Min.~Max. °CDB																											
Refrigerant				Type/GWP R-32/675																											
Piping connections				Evaporator water inlet/outlet (OD) mm																											
Unit				Starting current Max Running Cooling Nom. current Max																											
Power supply				Phase/Frequency/Voltage Hz/V																											

# Air cooled scroll chiller, high efficiency, reduced sound



Single V

EWAT-B-XS/XL/XR Modular V

Microtech III



> More information about EWAT-B-XR

Cooling Only				EWAT-B-XR																				
Space cooling				085	115	145	180	185	200	220	230	250	280	300	310	320	360	370	430	470	540	600	660	700
A Condition 35°C Pdc				kW																				
ηs,c				%																				
SEER				3,84 4,24 4,08 4,17 4,08 4,24 4,24 4,2 4,36 4,49 4,59 4,44 4,24 4,45 4,32 4,47 4,26 4,54 4,61 4,6 4,58																				
Cooling capacity				kW																				
Power input				kW																				
Capacity control				Staged Variable Staged Variable Staged Variable																				
Minimum capacity				%																				
EER				50 38 50 25 38 21 19 50 17 16 24 14 22 33 19 17 25 14 12 11 17																				
IPLV				4,74 5,1 4,76 5 4,78 5 5,05 4,82 4,93 5,09 5,15 5,02 4,72 5,05 4,9 4,86 4,82 4,91 5,07 4,99 4,99																				
Dimensions				mm																				
Unit				1.801 1.822 2.540 1.822																				
Height				2.236 1.204																				
Width				2.660 3.180 3.780 2.326 3.780 2.326 3.226 4.126 5.025 5.874 6.774																				
Depth				2.660 3.180 3.780 2.326 3.780 2.326 3.226 4.126 5.025 5.874 6.774																				
Weight				kg																				
Unit				744 837 961 1.732 1.072 1.763 1.790 1.977 2.054 2.192 2.212 2.220 2.247 2.590 2.627 2.811 3.237 3.458 3.873 4.248 4.396																				
Operation weight				kg																				
Water heat exchanger				Type																				
Water volume				l																				
Water flow rate				l/s																				
Water pressure drop				kPa																				
Air heat exchanger				Type																				
Compressor				Type																				
Quantity				2 4 2 4 2 4 3 4 3 4 5 6																				
Fan				Type																				
Quantity				6 8 10 4 10 4 5 6 7 8 9 10 12 13 14																				
Air flow rate				l/s																				
Speed				rpm																				
Sound power level				dB(A)																				
Sound pressure level				dB(A)																				
Operation range				°CDB																				
Refrigerant				Type/GWP																				
Charge				kg																				
Circuits				Quantity																				
Piping connections				mm																				
Unit				Starting current																				
Running current				A																				
Power supply				Phase/Frequency/Voltage																				



DATA CENTER APPLICATION



PROCESS COOLING APPLICATION



# Air cooled mini inverter heat pump

- › Top product in terms of energy efficiency and operation range
- › All capacities available in 2 versions: standard version and version with OP10 option (no freeze up of water when not in operation thanks to the water piping heater tape)
- › Easy ‚plug and play‘ installation
- › Amongst the most quiet units in the market (63dBA - sound power)
- › Single phase power supply and low starting currents make the unit ideal for residential applications
- › Weight reduced with 20% compared with the previous models.
- › Built-in Hydraulic kit: no buffer tank required, standard inverter driven pump, main flow sensor and switch included.
- › Standard wired remote control enables setting of different set points (cooling, heating, water leaving temperature) or based on outdoor conditions (weather dependent control). It has an alarm history, night time noise reduction function and is language based.



› More information about EWYQ-BVP

Heating & Cooling					EWYQ-BVP	004	005	006	008	
Cooling capacity	Nom.			kW	4,00 / 4,01	4,93 / 5,07	5,88 / 6,07	7,95 / 8,23		
Heating capacity	Nom.			kW	4,11 / 3,96	4,99 / 4,99	6,14 / 6,12	8,08 / 8,44		
	Max.			kW	5,1	6,0	-	-		
Power input	Cooling	Nom.		kW	1,27 / 0,840	1,61 / 1,12	1,87 / 1,13	2,57 / 1,65		
	Heating	Nom.		kW	1,19 / 0,860	1,46 / 1,09	1,75 / 1,28	2,31 / 1,84		
Capacity control	Method				Variable (inverter)					
EER					3,14 / 4,80	3,06 / 4,51	3,15 / 5,35	3,10 / 4,99		
COP					3,44 / 4,61	3,41 / 4,58	3,51 / 4,77	3,49 / 4,59		
Space heating	Average climate water outlet 35°C	General	ηs (Seasonal space heating efficiency)	%	155					
					159					
SCOP					4,03			4,21		
	Seasonal space heating eff. class				A++					
Dimensions	Unit	HeightxWidthxDepth			735x1.090x350			997x1.160x380		
Weight	Unit				83			106		
Water heat exchanger	Type				Braze plate					
	Water flow rate	Cooling	Nom.	l/min	11,5 / 11,5		14,1 / 14,5		16,9 / 17,4	
		Heating	Nom.	l/min	11,8 / 11,4		14,3 / 14,3		17,6 / 17,5	
Water volume				l	1			2		
Air heat exchanger	Type				Cross fin coil/Hi-X tubes and chromate coated waffle louvre fins			Cross fin coil/Hi-X tubes and PE coated waffle louvre fins		
					Hermetically sealed swing compressor					
Compressor	Quantity				1					
Fan	Type				Propeller fan					
	Quantity				1					
Air flow rate	Cooling	Nom.	Nom.	m <sup>3</sup> /min	53		72			
				m <sup>3</sup> /min	47,0		46,6			
Sound power level	Cooling	Nom.	Nom.	dBA	63		64			
				dBA	65		69			
Sound pressure level	Cooling	Nom.	Nom.	dBA	48		49			
				dBA	49		52			
Operation range	Air side	Cooling	Min.~Max.	°CDB	10~43		10~46			
			Heating	Min.~Max.	°CDB	-20~-25		-15~-25		
	Water side	Cooling	Min.~Max.	°CDB	5~22					
			Heating	Min.~Max.	°CDB	15 ~55				
Refrigerant	Type/GWP				R-410A/2.088			R-410A/2.087,5		
	Control				Electronic expansion valve					
Refrigerant charge	Circuits				1					
	Per circuit	Quantity			kg		2,10		2,70	
	Per circuit				TCO <sub>2</sub> Eq		4,4		5,6	
Water circuit	Piping connections diameter				1" MBSP					
Unit	Starting current		Max	A	15,7		19,9			
	Running current		Max	A	15,7		19,9			
Power supply	Phase/Frequency/Voltage				Hz/V 1N~/50/230					

# Air cooled mini inverter heat pump

- › Inverter technology to ensure low sound values and leader-of-class ESEER
- › Wide operating range
- › Built-in hydronic module: no buffer tank required and a standard pump and main switch are included
- › Easy 'plug and play' installation
- › Single phase power supply for residential applications, three phase power supply model available for light commercial applications

› More information about EWYQ-ACV3

› More information about EWYQ-ACW1



EWYQ-ACV3/ACW1

Digital controller

Heating & Cooling		EWYQ-ACV3/ACW1			009	010	011	009	011	013		
Cooling capacity	Nom.				kW	12,2 (1) / 8,60	13,6 (1) / 9,60	11,1 / 15,7 (1)	12,9 (1) / 9,10	15,7 (1) / 11,1	17,0 (1) / 13,3	
Heating capacity	Nom.				kW	9,90 / 10,2 (1)	11,7 (1) / 11,4	13,8 (1) / 12,9	10,90 / 11,20 (1)	13,2 (1) / 12,4	14,8 (1) / 13,9	
Power input	Cooling	Nom.				kW	2,83 / 2,85 (1)	3,28 / 3,41 (1)	3,90 / 4,13 (1)	3,05 / 3,08 (1)	4,13 (1) / 3,90	5,18 / 5,52 (1)
	Heating	Nom.				kW	2,43 (1) / 2,99	2,81 (1) / 3,46	3,20 (1) / 3,94	2,69 (1) / 3,31	3,07 (1) / 3,78	3,47 (1) / 4,27
Capacity control	Method				Inverter controlled							
EER						3,05 / 4,27 (1)	2,93 / 4,00 (1)	2,85 / 3,79 (1)	2,99 / 4,19 (1)	3,79 (1) / 2,85	2,57 / 3,08 (1)	
COP						3,30 / 4,19 (1)	3,29 / 4,17 (1)	3,27 / 4,30 (1)	3,28 / 4,17 (1)	3,27 / 4,31 (1)	3,25 / 4,28 (1)	
Space heating	Average climate water outlet 35°C	General	$\eta_{s}$ (Seasonal space heating efficiency) %	SCOP	Seasonal space heating eff. class	126	131	134	126	134	130	
						3,22	3,34	3,41	3,22	3,41	3,30	
Dimensions	Unit	Height	mm			1.435						
			Width	mm			1.420					
				Depth	mm			382				
Weight	Unit				kg							
Water heat exchanger	Type				Brazed plate							
	Water flow rate	Heating	Nom.	l/min	28,3	32,6	36,9	31,2	35,5	39,8		
					Water volume				l			
Air heat exchanger				Type								
Pump Standard	Nominal ESP unit	Cooling	Heating	kPa	60,5	57,8	53,2	59,2	53,2	40,9 / 45,6		
					57,1	52,5	47,3	54,1	49,1	36,6 / 43,5		
Hydraulic components	Expansion vessel				Volume							
					l							
Compressor	Type				Hermetically sealed scroll compressor							
	Quantity				1							
Fan	Type				Propeller fan							
	Quantity				2							
	Air flow rate	Cooling	Nom.	m <sup>3</sup> /min	96,0	100	97,0					
Heating					Nom.	m <sup>3</sup> /min	90,0					
	Fan motor	Speed	Cooling	Nom.			rpm					780
Heating					Nom.	rpm					760	
						Steps					8	
Sound power level	Cooling	Nom.	dBA			64,0				66,0		
			Heating	Nom.	dBA			60	64	60		
Sound pressure level	Cooling	Nom.			dBA			50				
			Heating	Nom.	dBA			50				
	Night quiet mode	Cooling			Nom.	dBA			45			
Heating			Nom.	dBA			42				43	
	Operation range	Air side		Cooling	Min.~Max.	°CDB	10~46					
Heating			Min.~Max.				°CDB	-15~35				
		Water side		Cooling	Min.~Max.	°CDB		5~20				
Heating			Min.~Max.				°CDB	30~50				
	Refrigerant	Type				R-410A						
Circuits				Quantity								
Control				Electronic expansion valve								
GWP				2,087,5								
Refrigerant charge	Per circuit				kg							
					TCO <sub>2,eq</sub>							
					6,16							
Water circuit	Piping				inch							
	Piping connections diameter				inch							
Power supply	Phase/Frequency/Voltage				Hz/V				1~/50/230			
									3N~/50/400			

(1) Underfloor program: cooling Ta 35°C - LWE 18°C (Dt: 5°C); heating Ta DB/WB 7°C/6°C - LWC 35°C (Dt: 5°C)

# Air cooled scroll inverter heat pump

- › Inverter chiller
- › High part load efficiency for low running cost
- › Minimal starting currents
- › No buffertank required for standard applications
- › Daikin scroll compressor
- › Wide operation range
- › Integrated hydronic module on request



› More information about EWYQ-CWN



› More information about EWYQ-CWP

Heating & Cooling		EWYQ-CWN/CWP		016	021	025	032	040	050	064					
Cooling capacity	Nom.		kW	16,8(1)/17,0(2)	21,0(1)/21,2(2)	25,3(1)/25,5(2)	31,6(1)/31,8(2)	42,1(1)/42,3(2)	50,5(1)/50,7(2)	63,2(1)/63,3(2)					
	Max.		kW	20,0(1)/20,2(2)	25,0(1)/25,2(2)	30,1(1)/30,3(2)	37,6(1)/37,8(2)	50,1(1)/50,3(2)	60,1(1)/60,3(2)	75,2(1)/75,3(2)					
Heating capacity	Nom.		kW	16,8(1)/16,6(2)	21,0(1)/20,8(2)	25,1(1)/24,9(2)	31,4(1)/31,2(2)	41,9(1)/41,7(2)	50,3(1)/50,1(2)	62,9(1)/62,7(2)					
	Power input	Cooling	Nom.	kW	5,93(1)/5,81(2)	7,61(1)/7,47(2)	9,60(1)/9,45(2)	12,9(1)/12,7(2)	15,1	19,2(1)/19,0(2)	25,7(1)/25,5(2)				
Capacity control	Method			5,60(1)/5,49(2)	6,89(1)/6,76(2)	8,74(1)/8,58(2)	10,8(1)/10,6(2)	13,7	17,5(1)/17,4(2)	21,6(1)/21,4(2)					
	Minimum capacity		%	Inverter controlled											
EER				2,84(1)/2,93(2)	2,77(1)/2,84(2)	2,63(1)/2,70(2)	2,45(1)/2,50(2)	2,79(1)/2,80(2)	2,63(1)/2,67(2)	2,46(1)/2,48(2)					
COP				3,00(1)/3,02(2)	3,05(1)/3,07(2)	2,87(1)/2,91(2)	2,91(1)/2,93(2)	3,06(1)/3,03(2)	2,87(1)/2,88(2)	2,91(1)/2,93(2)					
Space heating	Average climate water outlet 35°C	General	η <sub>sp</sub> (Seasonal space heating efficiency)	%	147(1)/144(2)					148(1)/154(2)		138(1)/139(2)		135(1)/138(2)	
					SCOP	3,75(1)/3,68(2)					3,78(1)/3,93(2)		3,53(1)/3,55(2)		3,45(1)/3,53(2)
Dimensions	Unit	HeightxWidthxDepth	mm	A+		A++		A+							
				1,684x1,370x774		1,684x1,680x774		1,684x2,360x780		1,684x2,980x780					
Weight	Unit		kg	268(1)/280(2)	321(1)/332(2)	321(1)/332(2)	403(1)/414(2)	579(1)/604(2)	579(1)/604(2)	741(1)/765(2)					
Water heat exchanger	Type			Braze plate											
	Water flow rate	Cooling	Nom.	l/min	48	60	72	90	120	145	181				
		Water pressure drop	Cooling	Total	kPa	8	10	14	8	10	14	8			
	Water volume			l	3		5		6		9				
Air heat exchanger	Type			Air cooled coil											
Compressor	Type			Hermetically sealed scroll compressor											
	Quantity			1	2		3		4		6				
Fan	Type			Axial											
	Quantity			1		2		2		4					
Air flow rate	Cooling	Nom.	m <sup>3</sup> /min	171		185		233		370		466			
				Heating	171		185		233		370		466		
Sound power level	Cooling	Nom.	dBA	78		80		81		83					
				Heating	78		80		81		83				
Operation range	Air side	Cooling	Min.~Max.	°CDB	-5~-43		-15~-35		-10~-20		25~50				
					Heating	-15~-35		-10~-20		25~50					
	Water side	Cooling	Min.~Max.	°CDB	-10~-20		25~50								
					Heating	25~50									
Refrigerant	Type/GWP			R-410A/2.087,5											
	Control			Electronic expansion valve											
Refrigerant charge	Circuits	Quantity	kg/TCO,Eq	1		2									
				7,60/15,9		9,60/20,0		7,60/15,9		9,60/20,0					
Water circuit	Piping connections diameter		inch	1-1/4" (female)				2" (female)							
	Piping		inch	1-1/4"				1-1/2"							
Unit	Starting current	Max	A	-		77,7		78,7		88,7		99,8			
				Running current	Max	A	22,2	25,3	26,4	35,2	47,4	49,6	67,2		
Power supply	Phase/Frequency/Voltage		Hz/V	3N~/50/400											

(1) EWAQ-CWN: Version without pump. (2) EWAQ-CWP: Version with pump. (3) VRV chiller uses only inverter compressors. Starting current is always less or equal to the maximum running current.



# Air cooled scroll inverter heat pump, split version

- › **Hydronic module for indoor installation** eliminating the need for glycol
- › **Ideal for colder climates** as the lack of glycol will allow for high efficiencies
- › Compact dimensions and limited pipework allow for **installation in very restricted spaces**
- › Easy transportation as separate units will fit in an elevator



SEHVX-BW

SERHQ-BW1

BRC21A53/54 (Optional)



› More information about SEHVX-BW



› More information about SERHQ-BW1

Heating & Cooling					SEHVX20BW/ SERHQ020BW1	SEHVX32BW/ SERHQ032BW1	SEHVX40BW/ SERHQ020BW1+SERHQ020BW1	SEHVX64BW/ SERHQ032BW1+SERHQ032BW1	
Cooling capacity	Nom.				21,2 (1)	31,8 (1)	42,3 (1)	63,3 (1)	
Heating capacity	Nom.				20,8 (2)	31,2 (2)	41,7 (2)	62,7 (2)	
Power input	Cooling	Nom.			7,47 (1)	12,7 (1)	15,1 (1)	25,5 (1)	
	Heating	Nom.			6,76 (2)	10,6 (2)	13,7 (2)	21,4 (2)	
EER					2,84	2,5	2,8	2,48	
COP					3,07	2,93	3,03	2,93	
Space heating	Average climate water outlet 35°C	General	SCOP ns (Seasonal space heating efficiency)	%		3,93	3,53	3,80	3,53
						154	138	149	138
						A++		A+	
Seasonal space heating eff. class									
Unit for indoor installation					SEHVX20BW	SEHVX32BW	SEHVX40BW	SEHVX64BW	
Dimensions	Unit	Height	mm		1.573				
		Width	mm		766				
		Depth	mm		396				
Weight	Unit	kg		97,0	105	137	153		
	Packed unit	kg		109	117	149	165		
Water side Heat exchanger	Type	Braze plate							
	Water volume	l		3	5	6	9		
	Water flow rate	Cooling	Nom.	l/min	60 (3)	90 (3)	120 (3)	181 (3)	
Heating		Nom.	l/min	60 (2)	90 (2)	120 (2)	181 (2)		
Sound power level	Nom.	dB(A)		63		66			
Operation range	Cooling	Ambient	Min.~Max.	°CDB	-5~43				
		Water side	Min.~Max.	°CDB	5 (4)~20				
	Heating	Ambient	Min.~Max.	°CDB	-15~35				
		Water side	Min.~Max.	°CDB	25~50				
Refrigerant	Type / GWP	R-410A / 2.087,5							
	Circuits	Quantity		1		2			
	Control	Electronic expansion valve							
Water circuit	Piping connections diameter	inch		1-1/4" (female)		2" (female)			
	Piping	inch		1-1/4"					
	Water pressure drop	Cooling	Nom.	kPa	17 (7)	24 (7)	19 (7)	29 (7)	
		Total water volume	l		4,2 (8)	5,8 (8)	7,9 (8)	11,0 (8)	
Power supply	Phase/Frequency/Voltage		Hz/V		3N~/50/400				
Outdoor Unit					SERHQ020BW1	SERHQ032BW1			
Dimensions	Unit	Height	mm		1.680				
		Width	mm		765				
		Depth	mm		930	1.240			
Weight	Unit	kg		240	316				
	Packed unit	kg		273	356				
Compressor	Quantity			2	3				
Fan	Type	Hermetically sealed scroll compressor							
	Type	Axial							
	Quantity			1	2				
	Air flow rate	Cooling	Nom.	m³/min	185	233			
Heating		Nom.	m³/min	185	233				

(1) Cooling: entering evaporator water temp. 12°C; leaving evaporator water temp. 7°C; ambient air temp. 35°C (2) Condition: Ta DB/WB 7°C/6°C - LWC 45°C (Dt=5°C) (3) Condition: Ta DB/WB 7°C - LWE 7°C (DT = 5°C) (4) Water can be used above 5°C. Between 0°C and 5°C a 30% glycol solution (propylene or ethylene) has to be used. Between 0°C and -10°C a 40% glycol solution (propylene or ethylene) has to be used (see installation manual and information related to OPZL option) (5) Excluding water volume in the unit. In most applications this minimum water volume will have a satisfying result. In critical processes or in rooms with a high heat load though, extra water volume might be required. Refer to operation range for more info. (6) Excluding the water volume in the unit. This volume will guarantee sufficient defrost energy for all applications, however, this volume can be multiplied by 0,66 if the heating setpoint is ≥ 45°C (eg. Fan coils) (7) This is PD between inlet & outlet connections of unit. It includes the water side heat exchanger pressure drop. (8) Including piping + PHE; excluding expansion vessel

# Air cooled multi-scroll heat pump, high efficiency, standard sound

- › Single refrigerant circuit (2 scroll compressors) with single evaporator
- › Compact design
- › Partial and total heat recovery option available
- › Stainless steel plate heat exchanger
- › MicroTech III controller with superior control logic and easy interface



› More information about EWYQ-G-XS

Heating & Cooling					EWYQ-G-XS		075	085	100	110	120	140	160
Cooling capacity	Nom.			kW	77,8	88,1	101	117	127	147	165		
Heating capacity	Nom.			kW	82,2	91,2	110	127	138	156	170		
Power input	Cooling	Nom.			kW	27,0	31,5	36,0	39,5	44,7	50,2	57,8	
		Heating			kW	26	29	34	39	43	50	54	
Capacity control	Method			Step									
	Minimum capacity			%	50	44	50	44	50	43	50		
EER					2,88	2,80	2,81	2,97	2,84	2,92	2,85		
COP					3,14	3,12	3,24	3,25	3,20	3,11	3,13		
IPLV					4,40	4,47	4,40	4,49	4,40	4,50			
Space heating	Average climate water outlet 35°C	General	ηs (Seasonal space heating efficiency)	%	131	129	142	140	142	138	140		
					SCOP	3,35	3,31	3,62	3,58	3,63	3,53	3,58	
Dimensions	Unit	Height		mm	1.800								
		Width		mm	1.195								
		Depth		mm	2.826		3.426		4.026				
Weight	Unit			kg	850	912	1.077	1.183	1.213	1.333	1.394		
		Operation weight		kg	858	921	1.088	1.194	1.224	1.344	1.411		
Water heat exchanger	Type			Braze plate									
	Water flow rate	Cooling	Nom.	l/s	3,7	4,2	4,8	5,6	6,1	7,0	7,9		
			Heating	Nom.	l/s	4,0	4,4	5,3	6,1	6,7	7,5	8,2	
	Water pressure drop	Cooling	Nom.	kPa	8,40	8,30	8,70	11,6	13,7	18,2	19,9		
Heating			Nom.	kPa	9,50	9,10	11,20	14,40	17,20	21,70	22,50		
Water volume				l	8,10	9,40	10,8				16,7		
Air heat exchanger	Type			High efficiency fin and tube type with integral subcooler									
Compressor	Type			Driven vapour compression									
	Quantity			2									
Fan	Type			Direct propeller									
	Quantity			6		8		10					
	Air flow rate	Nom.		l/s	10.042		9.861		13.148		16.435		
Speed				rpm	1.360								
Sound power level	Cooling	Nom.		dB(A)	84	85	87	89					
Sound pressure level	Cooling	Nom.		dB(A)	66	68	70	71					
Operation range	Air side	Cooling	Min.-Max.	°CDB	-10~45								
		Heating	Min.-Max.	°CDB	-10~45								
	Water side	Cooling	Min.-Max.	°CDB	-10~15								
		Heating	Min.-Max.	°CDB	-10~15								
Refrigerant	Type / GWP			R-410A / 2.087,5									
	Circuits			1									
Refrigerant charge	Per circuit			kg	15,0		18,0		23,0		30,0		
	TCO <sub>eq</sub>				31,3		37,6		48,0		62,6		
Piping connections	Evaporator water inlet/outlet (OD)			2" 1/2									
Unit	Starting current			Max	A	210	261	267	316	323	363	377	
	Running current	Cooling	Nom.	A	52	56	60	69	76	88	95		
			Max	A	66	72	78	87	95	111	125		
Power supply	Phase/Frequency/Voltage			Hz/V	3~/50/400								

# Air cooled multi-scroll heat pump, high efficiency, reduced sound



> More information about EWYQ-G-XR

Heating & Cooling					EWYQ-G-XR	075	085	100	110	120	140	160						
Cooling capacity	Nom.			kW	75,2	84,5	95,0	111	120	139	155							
Heating capacity	Nom.			kW	82,2	91,2	110	127	138	156	170							
Power input	Cooling	Nom.			kW	27,7	32,7	38,6	41,5	47,4	52,8	61,5						
		Heating			kW	26	29	34	39	43	50	54						
Capacity control	Method			Step														
	Minimum capacity			%	50	44	50	44	50	43	50							
EER					2,71	2,59	2,46	2,68	2,52	2,64	2,51							
COP					3,14	3,12	3,24	3,25	3,20	3,11	3,13							
IPLV					4,35	4,41	4,29	4,42	4,27	4,40	4,35							
Space heating	Average climate water outlet 35°C	General	ηs (Seasonal space heating efficiency)	%	131	129	142	140	142	138	140							
					SCOP	3,35	3,31	3,62	3,58	3,63	3,53	3,58						
Dimensions	Unit	Height			1.800													
		Width			1.195													
		Depth			2.826		3.426		4.026									
Weight	Unit			kg	880	942	1.107	1.213	1.243	1.363	1.424							
		Operation weight		kg	888	951	1.118	1.224	1.254	1.374	1.441							
Water heat exchanger	Type			Braze plate														
	Water flow rate	Cooling	Nom.			l/s	3,6	4,0	4,5	5,3	5,7	6,7	7,4					
			Heating			l/s	4,0	4,4	5,3	6,1	6,7	7,5	8,2					
	Water pressure drop	Cooling	Nom.			kPa	7,90	7,70	7,60	10,5	12,1	16,4	17,5					
			Heating			kPa	9,50	9,10	11,2	14,4	17,2	21,7	22,5					
Water volume					l	8,10	9,40	10,8			16,7							
Air heat exchanger	Type			High efficiency fin and tube type														
Compressor	Type			Driven vapour compression														
	Quantity			2														
Fan	Type			Direct propeller														
	Quantity			6		8		10		-								
	Air flow rate	Nom.		l/s		7.859	7.101	9.468	11.835									
	Speed					rpm					1.108							
Sound power level	Cooling	Nom.				80	82	84	86									
Sound pressure level	Cooling	Nom.				62	65	66	68		67							
Operation range	Air side	Cooling	Min.-Max.			°CDB					-10~45							
			Heating			°CDB					-17~20							
	Water side	Cooling	Min.-Max.			°CDB					-10~15							
			Heating			°CDB					25~50							
Refrigerant	Type / GWP			R-410A / 2.087,5														
	Circuits			Quantity								1						
Refrigerant charge	Per circuit					kg	17,0	17,7	23,5	29,4	28,3	32,0	34,9					
						TCO <sub>eq</sub>	35,5	36,9	49,1	61,4	59,1	66,8	72,9					
Piping connections	Evaporator water inlet/outlet (OD)			2" 1/2														
Unit	Starting current					A						213	264	270	319	327	367	381
	Running current	Cooling	Nom.			A						54	60	65	71	80	90	103
			Max			A						70	75	81	91	99	116	131
Power supply	Phase/Frequency/Voltage					Hz/V						3~/50/400						

# Air cooled multi-scroll heat pump, high efficiency, standard/low sound

- › **Class A efficiency in heating mode**
- › Extended operation range: ambient temperatures from -10°C up to +46°C in cooling mode and down to -17°C in heating mode
- › 2 truly independent refrigerant circuits
- › Reduced footprint thanks to the **V-shaped frame** (EWYQ160-230F-XS/XL & EWYQ160-220F-XR)
- › Reliable and efficient scroll compressors with **high EER values**
- › Chiller series design entirely based on new European directives (EN14511, EN14825)
- › Top serviceability level thanks to reduced weight, compact footprint and optimized components accessibility

- › The unit can be equipped with a hydraulic module optimizing installation time, space and cost
- › Wide range of available options and accessories
- › Inverter fans management for enhanced part load efficiencies
- › Nordic kit option to improve the chiller working conditions in heating mode
- › MicroTech III controller with superior control logic and easy interface

› More information about EWYQ-F-XS



› More information about EWYQ-F-XL



Heating & Cooling				EWYQ-F-XS/XL													
				160	190	210	230	310	340	380	400	430	510	570	630		
Cooling capacity	Nom.			kW	164	184	205	231	304	335	376	401	427	502	565	624	
Heating capacity	Nom.			kW	173	197	227	254	329	362	404	429	463	535	607	674	
Power input	Cooling	Nom.			kW	57,6	63,3	70,3	79,3	102	114	129	138	145	172	195	214
		Nom.			kW	54,0	61,6	70,5	79,2	101	113	126	133	140	167	190	210
Capacity control	Method			Step													
	Minimum capacity			%	25,0									17,0			
EER					2,84	2,91	2,92		2,99	2,93	2,91	2,90	2,94	2,92	2,90	2,91	
COP					3,20		3,22	3,21	3,24	3,21		3,23	3,30	3,21	3,20	3,21	
IPLV					4,45	4,47	4,55	4,38	4,56	4,61	4,38	4,50	4,70	4,71	4,56	4,74	
Space heating	Average climate water outlet 35°C	General	ηs (Seasonal space heating efficiency)	%	128	134	129		143	147							
					SCOP	3,28	3,42	3,31	3,30	3,64	3,75						
Dimensions	Unit	Height		mm	2.270				2.220								
		Width		mm	1.200				2.258								
		Depth		mm	4.370		5.270		4.125		5.025		5.925		6.825		
Weight (XS)	Unit			kg	1.430	1.850	2.300	2.350	2.900	2.910	2.920	3.730	3.750	4.250	4.280	4.670	
		Operation weight		kg	1.470	1.890	2.340	2.390	2.980	2.990	3.000	3.840	3.850	4.370	4.400	4.780	
Weight (XL)	Unit			kg	1.520	1.940	2.400	2.440	3.060	3.070	3.080	3.890	3.900	4.400	4.440	4.820	
		Operation weight		kg	1.570	1.980	2.440	2.480	3.130	3.150	3.160	3.990	4.010	4.520	4.550	4.940	
Water heat exchanger	Type			Plate heat exchanger													
	Water flow rate	Cooling	Nom.	l/s	7,8	8,8	9,8	11,1	14,6	16,0	18,0	19,2	20,4	24,0	27,1	29,9	
			Nom.	l/s	8,3	9,5	10,9	12,2	15,9	17,5	19,5	20,7	22,3	25,8	29,3	32,5	
	Water pressure drop	Cooling	Nom.	kPa	22	28	36	40	21	27	30	29	34	37	42	56	
			Nom.	kPa	25	32	43	50	25	31	37	33	40	43	50	66	
Water volume				l	18				44		60		70				
Air heat exchanger	Type			High efficiency fin and tube type with integral subcooler													
Compressor	Type			Driven vapour compression													
	Quantity			4													
Fan	Type			Direct propeller													
	Quantity			4		5		8			10		12		14		
	Air flow rate	Nom.	l/s		22.577	21.593	26.992		43.187			55.213	53.983	64.780		75.577	
			rpm		900												
Sound power level (XS)	Cooling	Nom.	dBA	92	94	95		97	98	99			100				
Sound power level (XL)	Cooling	Nom.	dBA	89	92	93			95		96		97		98		
Sound pressure level (XS)	Cooling	Nom.	dBA	72	74	75	76	77	78		79			80			
Sound pressure level (XL)	Cooling	Nom.	dBA	70	73		74	75			76	77					
Operation range	Air side	Cooling	Min.-Max.	°CDB	-10~46												
			Min.-Max.	°CDB	-17~20												
	Water side	Cooling	Min.-Max.	°CDB	-13~15												
			Min.-Max.	°CDB	25~50												
Refrigerant	Type / GWP			R-410A / 2.087,5													
	Circuits			2													
Refrigerant charge	Per circuit			kg	16,0	20,0		24,0	35,0	36,0	35,0	46,0		55,0	52,5	68,0	
	TCO <sub>eq</sub>				33,4	41,8		50,1	73,1	75,2	73,1	96,0		114,8	109,6	142,0	
Piping connections	Evaporator water inlet/outlet (OD)			2,5"													
	Unit	Starting current		Max	A	282	536	353	560	600	516	637	659	666	648	787	827
		Running current	Cooling	Nom.	A	115	140	128	162	193	205	235	251	257	307	353	384
Max	A			138	165	164	196	246	264	295	316	330	396	442	491		
Power supply	Phase/Frequency/Voltage			Hz/V	3~/50/400												

# Air cooled multi-scroll heat pump, high efficiency, reduced sound



> More information about EWYQ-F-XR

Heating & Cooling					EWYQ-F-XR												
					160	180	200	220	300	330	360	390	420	490	550	610	
Space cooling	A Condition 35°C	Pdc	kW												606,1		
	η <sub>s,c</sub>		%												171,8		
SEER															4,371		
Cooling capacity	Nom.	kW		158	178	199	223	296	326	363	389	415	487	546	606		
Heating capacity	Nom.	kW		173	197	227	254	329	362	404	429	463	535	607	674		
Power input	Cooling	Nom.	kW		56,2	62,3	68,4	77,9	97,4	111	127	134	141	167	191	210	
	Heating		kW		54,0	61,6	70,5	79,2	101	113	126	133	140	167	190	210	
Capacity control	Method	Step										Staged					
	Minimum capacity	%		25,0										17,0			
EER					2,81	2,86	2,92	2,87	3,04	2,93	2,86	2,90	2,93	2,91	2,85	2,89	
COP					3,20		3,22	3,21	3,24	3,21		3,23	3,30	3,21	3,20	3,21	
IPLV					5,11	5,18	5,22	4,96	5,25	5,35	4,97	5,08	5,25	5,54	5,13	5,36	
Space heating	Average climate water outlet 35°C	General	η <sub>s</sub> (Seasonal space heating efficiency)	%		128	134	129		143	147						
			SCOP	%		3,28	3,42	3,31	3,30	3,64	3,75						
Dimensions	Unit	Height	mm		2.270					2.220							
		Width	mm		1.200					2.258							
		Depth	mm		4.370		5.270		4.125		5.025		5.925		6.825		
Weight	Unit	kg		1.520	1.940	2.400	2.440	3.060	3.070	3.080	3.890	3.900	4.400	4.440	4.820		
		Operation weight		kg	1.570	1.980	2.440	2.480	3.130	3.150	3.160	3.990	4.010	4.520	4.550	4.940	
Water heat exchanger	Type				Plate heat exchanger												
	Water flow rate	Cooling	Nom.	l/s	7,5	8,5	9,6	10,7	14,2	15,6	17,4	18,6	19,8	23,3	26,1	29,0	
		Heating	Nom.	l/s	8,3	9,5	10,9	12,2	15,9	17,5	19,5	20,7	22,3	25,8	29,3	32,5	
	Water pressure drop	Cooling	Nom.	kPa	20	26	34	38	20	25	28	27	32	35	39	53	
		Heating	Nom.	kPa	25	32	43	50	25	31	37	33	40	43	50	66	
Water volume			l	18				44			60		70				
Air heat exchanger	Type				High efficiency fin and tube type with integral subcooler												
Compressor	Type				Driven vapour compression												
	Quantity				4					6							
Fan	Type				Direct propeller												
	Quantity				4		5		8		10		12		14		
	Air flow rate	Nom.	l/s		17.380	16.564	20.706		33.129		42.431	41.411	49.693		57.975		
Speed	rpm				700												
Sound power level	Cooling	Nom.	dBA		83	84	86		88		89		90		92		
Sound pressure level	Cooling	Nom.	dBA		64	65	66	67	69		70		71				
Operation range	Air side	Cooling	Min.~Max.	°CDB	-10~46												
		Heating	Min.~Max.	°CDB	-17~20												
	Water side	Cooling	Min.~Max.	°CDB	-13~15												
		Heating	Min.~Max.	°CDB	25~50												
Refrigerant	Type / GWP				R-410A / 2.087,5												
	Circuits				Quantity				2								
Refrigerant charge	Per circuit				kg	16,0	18,0	20,0	24,0	35,0	36,0	35,0	46,0		55,0		68,0
					TCO <sub>2</sub> eq	33,4	37,6	41,8	50,1	73,1	75,2	73,1	96,0		114,8		142,0
Piping connections	Evaporator water inlet/outlet (OD)				2,5"					3"							
Unit	Starting current	Max		A	276	530	346	553	589	505	626	645	652	631	770	807	
	Running current	Cooling	Nom.	A	114	138	126	160	187	201	232	245	252	301	350	379	
		Max		A	133	160	157	189	235	253	283	302	316	379	425	471	
Power supply	Phase/Frequency/Voltage				Hz/V										3~/50/400		

# Air cooled screw inverter heat pump, standard efficiency, standard sound

- › Ideal solution for **commercial comfort cooling and/or heating applications**
- › 2-3 truly independent refrigerant circuits
- › Low starting current
- › DX shell and tube evaporator – one pass refrigerant side to minimize pressure drops
- › Standard electronic expansion valve
- › Optimised defrost cycles
- › Partial and total heat recovery option available
- › Power factor up to 0.95
- › PID microprocessor control



› More information about EWYD-BZSS

Heating & Cooling		EWYD-BZSS		250	270	290	320	340	370	380	410	440	460	510	520	580		
Cooling capacity	Nom.	kW		253	272	291	323	337	363	380	411	433	455	502	519	580		
Heating capacity	Nom.	kW		271	298	325	334	350	380	412	445	465	477	533	561	618		
Power input	Cooling	Nom.	kW		91,3	101	110	117	125	135	144	154	165	163	182	189	218	
	Heating	Nom.	kW		91,4	100	108	118	126	133	143	157	167	165	178	186	208	
Capacity control	Method		Stepless															
	Minimum capacity		%		13,0							9,0						
EER					2,77	2,70	2,65	2,75	2,69	2,68	2,63	2,66	2,62	2,79	2,76	2,74	2,67	
COP					2,96	2,97	3,00	2,82	2,78	2,85	2,88	2,83	2,79	2,88	2,99	3,01	2,97	
IPLV					4,58	4,62		4,75	4,64	4,71	4,67	4,73	4,69	4,85	4,89	4,85	4,78	
Space heating	Average climate water outlet 35°C	General	ηs (Seasonal space heating efficiency)	%	125							-						
					SCOP		3,21		3,20		3,21			-				
Dimensions	Unit	Height	mm		2.335							2.280						
		Width	mm		2.254													
		Depth	mm		3.547			4.428				5.329			6.659			
Weight	Unit	kg		3.410	3.455	3.500	3.870		3.940	4.010	4.390		5.015	5.495	5.735			
		Operation weight		kg	3.550	3.595	3.640	4.010		4.068	4.138	4.518		5.255	5.724	5.964	5.953	
Water heat exchanger	Type		Single pass shell & tube															
	Water flow rate	Cooling	Nom.	l/s		12,1	13,0	13,9	15,5	16,2	17,4	18,2	19,7	20,8	21,8	24,1	24,9	27,8
		Heating	Nom.	l/s		13,1	14,4	15,7	16,1	16,9	18,3	19,8	21,4	22,4	23,0	25,6	27,0	29,7
	Water pressure drop	Cooling	Nom.	kPa		40	46	44	50	55	60	65	74	80	47	85	91	61
Heating		Nom.	kPa		30	35	52	37	40	45	51	59	64	42	63	69	59	
Water volume		l		138			133			128			240		218			
Air heat exchanger	Type		High efficiency fin and tube type with integral subcooler															
Compressor	Type		Driven vapour compression															
	Quantity		2							3								
Fan	Type		Direct propeller															
	Quantity		6			8				10			12					
	Air flow rate	Nom.	l/s		31.729	31.422	31.115	42.306		42.337	41.487	52.882		63.458	62.640	61.652	62.231	
Speed		rpm		900														
Sound power level	Cooling	Nom.	dBA		101							102			104			
Sound pressure level	Cooling	Nom.	dBA		82							83			84			
Operation range	Air side	Cooling	Min.-Max.	°CDB		-10~45												
		Heating	Min.-Max.	°CDB		-10~20												
	Water side	Cooling	Min.-Max.	°CDB		-8~15												
		Heating	Min.-Max.	°CDB		35~55												
Refrigerant	Type / GWP		R-134a / 1.430															
Refrigerant charge	Per circuit	kg		43,0	44,0	43,0	46,0	46,5		47,0	50,0		47,0		49,0			
		TCO <sub>eq</sub>		61,5	62,9	61,5	65,8	66,5		67,2	71,5		67,2		70,1			
Piping connections	Evaporator water inlet/outlet (OD)		mm		139,7							219,1						
Unit	Starting current	Max		A		150			181		204		224	238	245	300	323	
	Running current	Cooling	Nom.	A		137	150	164	176	188	202	214	229	244	246	270	281	322
		Max		A		211		212		254		288		316	336	329	398	432
Power supply	Phase/Frequency/Voltage		Hz/V		3~/50/400													

# Air cooled screw inverter heat pump, standard efficiency, low sound



EWYD-BZSS/SL

MicroTech II

› More information about EWYD-BZSL



Heating & Cooling					EWYD-BZSL										250	270	290	320	330	360	370	400	430	450	490	510	570
Cooling capacity	Nom.			kW	247	265	290	315	330	353	370	401	423	446	490	507	565										
Heating capacity	Nom.			kW	271	298	325	334	350	380	412	445	465	477	533	561	618										
Power input	Cooling	Nom.			kW	89,5	99,5	110	115	123	134	144	151	163	158	177	186	216									
			Heating	Nom.			kW	91,4	100	108	118	126	133	143	157	167	165	178	186	208							
Capacity control	Method				Stepless																						
	Minimum capacity				%	13,0									9,0												
EER						2,76	2,66	2,62	2,75	2,68	2,64	2,57	2,66	2,59	2,83	2,77	2,73	2,61									
COP						2,96	2,97	3,00	2,82	2,78	2,85	2,88	2,83	2,79	2,88	2,99	3,01	2,97									
IPLV						4,90	4,96	4,91	5,17	5,08	5,12	5,06	5,22	5,13	5,07	5,03	4,99	4,90									
Space heating	Average climate water outlet 35°C	General	ηs (Seasonal space heating efficiency)	SCOP	%	125						-															
						3,21		3,20		3,21		-		-		-											
Dimensions	Unit	Height		mm		2.335						2.280															
		Width		mm		2.254																					
		Depth		mm		3.547		4.428		5.329		6.659															
Weight	Unit				kg		3.750	3.795	3.840	4.210	4.280	4.350	4.730	5.525	6.005	6.245											
	Operation weight				kg		3.888	3.933	3.978	4.343	4.408	4.478	4.858	5.765	6.234	6.474	6.463										
Water heat exchanger	Type				Single pass shell & tube																						
	Water flow rate	Cooling	Nom.	l/s		11,8	12,7	13,9	15,1	15,8	16,9	17,7	19,2	20,3	21,4	23,5	24,3	27,1									
				Heating	Nom.	l/s		13,1	14,4	15,7	16,1	16,9	18,3	19,8	21,4	22,4	23,0	25,6	27,0	29,7							
	Water pressure drop	Cooling	Nom.			kPa		38	44	42	48	53	57	62	71	77	45	82	87	58							
Heating				Nom.	kPa		30	35	52	37	40	45	51	59	64	42	63	69	59								
	Water volume				l		138			133			128			240		229		218							
Air heat exchanger	Type				High efficiency fin and tube type with integral subcooler																						
Compressor	Type				Driven vapour compression																						
	Quantity				2						3																
Fan	Type				Direct propeller																						
	Quantity				6				8				10				12										
	Air flow rate	Cooling	Nom.	l/s		24.432	24.264	24.095	32.576	32.628	32.127	40.720	48.863	48.415	47.732	48.191											
Speed				rpm		700																					
Sound power level	Cooling	Nom.		dB(A)		94						95						97									
Sound pressure level	Cooling	Nom.		dB(A)		76						77															
Operation range	Air side	Cooling	Min.~Max.	°CDB		-10~45																					
				Heating	Min.~Max.	°CDB		-10~20																			
	Water side	Cooling	Min.~Max.			°CDB		-8~15																			
				Heating	Min.~Max.	°CDB		35~55																			
Refrigerant	Type / GWP					R-134a / 1.430																					
Refrigerant charge	Per circuit	Quantity		kg		2						3															
		TCO <sub>eq</sub>		kg		43,0	44,0	43,0	46,0	46,5	47,0	50,0	47,0	49,0													
Piping connections	Evaporator water inlet/outlet (OD)		mm		139,7						219,1																
Unit	Starting current	Max		A		145	146	176	199	217	231	234	288	311	305												
		Running current	Cooling	Nom.	A		134	148	163	171	184	199	212	224	240	238	263	275	319								
	Max				A		202	203	243	277	302	322	313	381	415	406											
Power supply	Phase/Frequency/Voltage		Hz/V		3~/50/400																						



# EWYD-4Z

Air to water  
Multipurpose unit

4-pipe system solution with full inverter technology  
For independent and simultaneous cooling and heating all year round

## 1

### Top class efficiency

Total Energy Ratio up to 8.8

Full inverter technology:  
the best choice for  
every application

#### **Daikin single screw compressor with integrated inverter and Variable Volume Ratio Technology**

The inverter integrated in the compressor is refrigerant cooled:

- > Safe and robust cooling system, totally independent from outdoor ambient conditions and air quality.
- > Suitable even for aggressive installation such as industrial or desert application.

The volume ratio will change by moving the sliding valves.

**VVR** changes the point at which the gas leaves the compressor, and therefore changes the pressures at discharge which will be optimal at any condition.

## 2

### Application flexibility

Wide operating envelope for cooling and heating

#### **Rapid Restart functionality**

In case of power failure DAIKIN 4Z is able to restart in less than 30 sec. The UPS installed in electrical box keeps the unit controller always powered. Is also possible to give, if needed, priority to restore the cooling or the heating load.

## 3

### Best solution for simultaneous cooling and heating

Big multipurpose buildings, hotels, hospital are just a few examples of application for multipurpose units

> Daikin EWYD-4Z Multipurpose Unit

> Daikin EWYD-4Z Multipurpose Unit – Behind the scenes

Check on  
**YouTube**

[www.youtube.com/DaikinEurope](http://www.youtube.com/DaikinEurope)

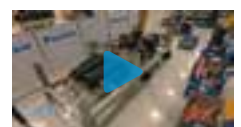



# Air to Water Multipurpose unit

- › Best solution for independent and simultaneous cooling and heating all year round
- › Top class efficiency due to Full inverter technology
- › Daikin single screw compressor with integrated inverter and Variable Volume Ratio Technology
- › High Efficiency Inverter fans with optimized geometry ensures the best ratio between airflow and power input.
- › Wide operating envelope for cooling and heating with extra capacity in Boosted operation and Rapid Restart functionality



› More information about EWYD-4ZXS



EWYD-4ZXS

Multipurpose		EWYD-4ZXS	400	450	500	550	600	650	700	800	
SEER			4,77	5,02	5,11	5,14	5,17	5,21	5,25	5,28	
ηsc			187,8	197,8	201,4	202,6	203,8	205,4	207,0	208,2	
SCOP			3,68	3,84	3,82	3,80	3,80	-	-	-	
ηs			144,2	150,4	149,6	149,0	148,8	-	-	-	
Air to water – cooling only (1)	Nominal Rated Capacity – Gross	kW	403	453	504	552	604	655	705	804	
	EER – Gross		3,19	3,28	3,27	3,28	3,27	3,23	3,41	3,40	
	Nominal Rated Capacity – Net	kW	402	452	503	551	602	654	703	802	
	EER – Net		3,17	3,25	3,25	3,25	3,24	3,19	3,37	3,36	
Air to water – heating only (2)	Nominal Rated Capacity – Gross	kW	402	453	502	549	599	653	701	800	
	COP – Gross		3,34	3,53	3,47	3,49	3,47	3,40	3,58	3,57	
	Nom. Rated Capacity – Net	kW	403	453	504	551	601	655	702	803	
	COP – Net		3,33	3,52	3,45	3,47	3,45	3,38	3,55	3,54	
Water to water – Cooling + heating (3)	Nom. Rated Capacity COOLING – Gross	kW	314	356	395	432	476	513	551	632	
	Nom. Rated Capacity HEATING – Gross	kW	402	454	502	548	602	651	702	801	
	TER – Gross		8,14	8,32	8,35	8,43	8,57	8,44	8,30	8,47	
	Nom. Rated Capacity COOLING – Net	kW	313	356	394	430	475	511	549	630	
	Nom. Rated Capacity HEATING – Net	kW	402	455	503	549	603	653	704	803	
	TER – Net		8,03	8,19	8,20	8,24	8,38	8,23	8,10	8,26	
Dimensions	Height	mm	2.455								
	Width	mm	2.240								
	Length	mm	5.775		6.675		7.575		8.475		
Weight	Unit Weight	kg	6.600	6.710	7.480	7.480	8.250	9.020	9.020	9.020	
	Operating Weight	kg	6.898	7.008	7.982	7.960	8.828	9.598	9.607	9.598	
Sound level	Cold/Hot side water connections	mm	139,7			168,3					
	Sound Power – Cooling (4)	dB(A)	99		99		100		102		
	Sound Pressure – Cooling at 1 m (5)	dB(A)	78	77		78	79	80			
	Sound Power – Heating (4)	dB(A)	98			99		100	101	102	
	Sound Pressure – Heating at 1 m (5)	dB(A)	78	77		78		79	80		
Water heat exchangers	Cold Side	Water Volume	149		262	240	298		307	280	
		Water flow rate (1)	19,2	21,6	24,0	26,3	28,8	31,3	33,6	38,3	
		Water pressure drop (1)	13,7	16,9	20,5	31,4	28,0	32,7	33,9	31,5	
	Hot Side	Water Volume	149		240		280		298		
		Water flow rate (2)	19,4	21,9	24,3	26,6	29,0	31,6	33,9	38,7	
		Water pressure drop (2)	13,0	16,1	23,9	27,6	30,0	35,3	32,8	42,5	
Fan	Quantity	n	10		12		14	16			
	Nominal air flow (1)	l/s	38.889		46.667		54.444	62.222			
Compressor	Type		Driven vapour compression								
	Oil charge	l	26							36	
	Quantity	n.	2								
Refrigerant circuit	Refrigerant type		R-134a								
	Refrigerant charge	kg	170	175	190	210	235	255	265	285	
	Circuits	n.	2								
Power Supply	Phase/Frequency/Voltage	Hz/V	3~/50/400								

Fluid: Water; Fouling factor = 0

(1) Operation in Air to water "Cooling only" mode rated at 35°C ambient temperature, 50% R.H.; Entering water temperature 12°C, Outlet water temperature 7°C.

(2) Operation in Air to water "Heating only" mode rated at 7°C ambient temperature, 85% R.H.; Entering water temperature 40°C, Outlet water temperature 45°C.

(3) Operation in Water to water "Cooling + Heating" mode rated with water flowing on cold and hot heat exchangers determined respectively at conditions (1) and (2) - Chilled water outlet temperature 7°C, Hot water outlet temperature 45°C.

(4) Sound power level are referred to condition (1) for Cooling and (2) for Heating. The data are measured in accordance with ISO 9614 and Eurovent 8/1 for Eurovent certified units.

The certification refers only to the overall sound power level.

(5) Sound pressure is calculated from the sound power level and it is for information only and not considered binding.

All the above data are referred to standard units without options and are subject to change without notice.

# Air to Water Multipurpose unit

- › Best solution for independent and simultaneous cooling and heating all year round
- › Top class efficiency due to Full inverter technology
- › Daikin single screw compressor with integrated inverter and Variable Volume Ratio Technology
- › High Efficiency Inverter fans with optimized geometry ensures the best ratio between airflow and power input.
- › Wide operating envelope for cooling and heating with extra capacity in Boosted operation and Rapid Restart functionality

› More information  
about EWYD-4ZXL



Multipurpose		EWYD-4ZXL	400	450	500	550	600	650	700	800	
SEER			4,91	5,14	5,20	5,31	5,34	5,36	5,44	5,52	
η <sub>sc</sub>			193,4	202,6	205,0	209,4	210,6	211,4	214,6	217,8	
SCOP			4,08	4,35	4,25	4,33	4,23	-	-	-	
η <sub>s</sub>			160,2	171,2	166,9	170,3	166,0	-	-	-	
Air to water – cooling only (1)	Nominal Rated Capacity – Gross	kW	399	449	500	548	599	650	697	794	
	EER – Gross		3,30	3,35	3,38	3,35	3,36	3,34	3,51	3,44	
	Nominal Rated Capacity – Net	kW	399	448	499	546	598	649	696	792	
	EER – Net		3,28	3,33	3,35	3,32	3,33	3,30	3,47	3,40	
Air to water – heating only (2)	Nominal Rated Capacity – Gross	kW	398	448	498	544	594	647	694	795	
	COP – Gross		3,61	3,80	3,75	3,75	3,75	3,68	3,87	3,88	
	Nom. Rated Capacity – Net	kW	398	449	499	545	595	649	696	798	
	COP – Net		3,59	3,78	3,73	3,73	3,72	3,66	3,84	3,85	
Water to water – Cooling + heating (3)	Nom. Rated Capacity COOLING – Gross	kW	311	352	395	432	470	513	545	632	
	Nom. Rated Capacity HEATING – Gross	kW	398	448	502	548	593	651	694	801	
	TER – Gross		8,13	8,30	8,35	8,44	8,61	8,45	8,30	8,48	
	Nom. Rated Capacity COOLING – Net	kW	310	351	394	431	468	512	543	630	
	Nom. Rated Capacity HEATING – Net	kW	398	449	503	550	595	653	696	804	
	TER – Net		8,02	8,17	8,20	8,25	8,42	8,24	8,10	8,26	
Dimensions	Height	mm	2.455								
	Width	mm	2.240								
	Length	mm	5.775		6.675		7.575		8.475		
Weight	Unit Weight	kg	6.600	6.710	7.480		8.250		9.020		
	Operating Weight	kg	6.898	7.008	7.982	7.960	8.828	9.598	9.607	9.598	
	Cold/Hot side water connections	mm	139,7			168,3					
Sound level	Sound Power – Cooling (4)	dB(A)	93	92	93		94		96		
	Sound Pressure – Cooling at 1 m (5)	dB(A)	72	71	72		73	74	75		
	Sound Power – Heating (4)	dB(A)	92			93	93	94	95	96	
	Sound Pressure – Heating at 1 m (5)	dB(A)	72	71		72			74	75	
	Water heat exchangers	Cold Side	Water Volume	149		262	240	298		307	280
Water flow rate (1)			19,0		21,4	23,9	26,1	28,6	31,0	33,3	37,9
Water pressure drop (1)			13,5		16,7	20,2	30,9	27,6	32,3	33,2	30,8
Hot Side		Water Volume	149		240		280		298		
		Water flow rate (2)	19,2		21,7	24,1	26,3	28,7	31,3	33,6	38,5
		Water pressure drop (2)	12,8		15,8	23,5	27,1	29,5	34,7	32,3	41,9
Fan	Quantity	n	10	10	12	12	14	16	16	16	
	Nominal air flow (1)	l/s	34.722		41.667		48.611	55.556			
Compressor	Type		Driven vapour compression								
	Oil charge	l	26							36	
	Quantity	n.	2								
Refrigerant circuit	Refrigerant type		R-134a								
	Refrigerant charge	kg	170	175	190	210	235	255	265	285	
	Circuits	n.	2								
Power Supply	Phase/Frequency/Voltage	Hz/V	3~/50/400								

Fluid: Water; Fouling factor = 0

(1) Operation in Air to water "Cooling only" mode rated at 35°C ambient temperature, 50% R.H.; Entering water temperature 12°C, Outlet water temperature 7°C.

(2) Operation in Air to water "Heating only" mode rated at 7°C ambient temperature, 85% R.H.; Entering water temperature 40°C, Outlet water temperature 45°C.

(3) Operation in Water to water "Cooling + Heating" mode rated with water flowing on cold and hot heat exchangers determined respectively at conditions (1) and (2) - Chilled water outlet temperature 7°C, Hot water outlet temperature 45°C.

(4) Sound power level are referred to condition (1) for Cooling and (2) for Heating. The data are measured in accordance with ISO 9614 and Eurovent 8/1 for Eurovent certified units. The certification refers only to the overall sound power level.

(5) Sound pressure is calculated from the sound power level and it is for information only and not considered binding. All the above data are referred to standard units without options and are subject to change without notice.

# Air to Water Multipurpose unit



› More information about EWYD-4ZXR

Multipurpose		EWYD-4ZXR	400	450	500	550	600	650	700	800	
SEER			4,76	5,01	5,19	5,23	5,30	5,30	4,87	5,28	
η <sub>sc</sub>			187,4	197,4	204,6	206,2	209,0	209,0	191,8	208,2	
SCOP			3,90	4,12	4,07	4,13	4,03	3,98	3,92	-	
η <sub>s</sub>			152,9	161,9	159,8	162,2	158,1	156,3	153,7	-	
Air to water – cooling only (1)	Nominal Rated Capacity – Gross	kW	358	401	453	497	549	598	620	691	
	EER – Gross		3,07	3,08	3,15	3,09	3,13	3,10	3,22	3,10	
	Nominal Rated Capacity – Net	kW	358	400	452	496	548	597	619	690	
Air to water – heating only (2)	EER – Net		3,05	3,06	3,12	3,06	3,11	3,07	3,19	3,08	
	Nominal Rated Capacity – Gross	kW	358	398	451	492	549	599	620	689	
	COP – Gross		3,49	3,66	3,66	3,65	3,61	3,58	3,70	3,74	
Water to water – Cooling + heating (3)	Nom. Rated Capacity – Net	kW	358	399	452	493	551	601	621	691	
	COP – Net		3,48	3,65	3,65	3,63	3,59	3,55	3,67	3,71	
	Nom. Rated Capacity COOLING – Gross	kW	280	313	356	389	436	474	488	545	
Dimensions	Nom. Rated Capacity HEATING – Gross	kW	359	399	452	493	549	599	623	692	
	TER – Gross		8,10	8,28	8,34	8,46	8,69	8,58	8,22	8,41	
	Nom. Rated Capacity COOLING – Net	kW	280	313	355	388	435	473	486	544	
	Nom. Rated Capacity HEATING – Net	kW	360	400	453	494	551	601	624	694	
	TER – Net		7,99	8,17	8,20	8,29	8,51	8,38	8,05	8,23	
Weight	Height	mm	2.455								
	Width	mm	2.240								
	Length	mm	5.775		6.675		7.575	8.475			
Sound level	Unit Weight	kg	7.100	7.210	7.980	7.980	8.750	9.520	9.720	9.720	
	Operating Weight	kg	7.398	7.508	8.482	8.460	9.328	10.098	10.307	10.298	
	Cold/Hot side water connections	mm	139,7	139,7	168,3	168,3	168,3	168,3	168,3	168,3	
	Sound Power – Cooling (4)	dB(A)	87	86	87		88		90		
Water heat exchangers	Sound Pressure – Cooling at 1 m (5)	dB(A)	66							68	69
	Sound Power – Heating (4)	dB(A)	88		89			90	91	92	
	Sound Pressure – Heating at 1 m (5)	dB(A)	68	67	68				69	70	
	Fan	Water Volume	l	149		262	240	298		307	280
Water flow rate (1)		l/s	17,1	19,1	21,6	23,7	26,2	28,5	29,6	33,0	
Water pressure drop (1)		kPa	11,1	13,6	16,9	25,8	23,4	27,7	26,7	24,0	
Compressor		Water Volume	l	149		240		280		298	
		Water flow rate (2)	l/s	17,3	19,3	21,8	23,8	26,6	29,0	30,0	33,3
		Water pressure drop (2)	kPa	11,1	13,5	20,3	23,7	27,0	31,6	27,5	33,3
Refrigerant circuit	Quantity	n	10			12		14		16	
	Nominal air flow (1)	l/s	19.444		23.333		27.222		31.111		
Power Supply	Type		Driven vapour compression								
	Oil charge	l	26							36	
Refrigerant circuit	Quantity	n.	2								
	Refrigerant type		R-134a								
	Refrigerant charge	kg	170	175	190	210	235	255	265	285	
Power Supply	Circuits	n.	2								
	Phase/Frequency/Voltage	Hz/V	3~/50/400								

Fluid: Water; Fouling factor = 0

(1) Operation in Air to water "Cooling only" mode rated at 35°C ambient temperature, 50% R.H.; Entering water temperature 12°C, Outlet water temperature 7°C.

(2) Operation in Air to water "Heating only" mode rated at 7°C ambient temperature, 85% R.H.; Entering water temperature 40°C, Outlet water temperature 45°C.

(3) Operation in Water to water "Cooling + Heating" mode rated with water flowing on cold and hot heat exchangers determined respectively at conditions (1) and (2) - Chilled water outlet temperature 7°C, Hot water outlet temperature 45°C.

(4) Sound power level are referred to condition (1) for Cooling and (2) for Heating. The data are measured in accordance with ISO 9614 and Eurovent 8/1 for Eurovent certified units.

The certification refers only to the overall sound power level.

(5) Sound pressure is calculated from the sound power level and it is for information only and not considered binding.

All the above data are referred to standard units without options and are subject to change without notice.



# Table of content

# Condensing Unit

ERAD-E-SS	94
ERAD-E-SL	95
Options	96
<u>Accessories</u>	<u>100</u>

# Air cooled screw condensing unit, standard efficiency, standard sound

- › One refrigerant circuit with single screw compressor
- › Compact design
- › Large operation range (ambient temperature down to -18°C)
- › Extensive option list (heat recovery option available)

› More information  
about ERAD-E-SS



Cooling only		ERAD-E-SS	120	140	170	200	220	250	310	370	440	490	
Cooling capacity	Nom.	kW	121	144	165	196	219	251	309	370	435	488	
Power input	Cooling	Nom. kW	42,1	51,2	57,7	65,6	74,2	77,0	93,8	123	148	161	
Capacity control	Method		Stepless										
	Minimum capacity	%	25,0										
EER			2,88	2,82	2,86	2,99	2,95	3,27	3,30	3,02	2,95	3,02	
Dimensions	Unit	Height	2.273						2.223				
		Width	1.292						2.236				
		Depth	2.165		3.065		3.965		3.070				
Weight	Unit	kg	1.584		1.741		1.936		2.679				
	Operation weight	kg	1.617		1.781		1.981		2.756				
Air heat exchanger	Type		High efficiency fin and tube type with integral subcooler										
Compressor	Type		Driven vapour compression										
	Quantity		1										
Fan	Type		Direct propeller										
	Air flow rate	Nom.	l/s	10.924	10.576	16.386	15.865	21.848	21.153	32.772	31.729		
	Quantity		2		3		4		6				
Sound power level	Cooling	Nom.	rpm	92				93		94		95	
				74				75		76			
Sound pressure level	Cooling	Nom.	dBA	74				75		76			
				-9~12				-18~48					
Operation range	Saturated suction temp.	Condenser inlet temp.	°C	-9~12				-18~48					
				R-134a / 1.430									
Refrigerant	Type / GWP		R-134a / 1.430										
	Circuits	Quantity	1										
Piping connections	Evaporator water inlet/outlet (OD)	mm	76						139,7				
Unit	Maximum starting current	A	151		195		288		330		410		
	Nominal running current (RLA)	Cooling	A	72	88	98	110	125	129	158	204	244	266
	Maximum running current	A	86	103	119	132	157	164	198	242	284	298	
Power supply	Phase/Frequency/Voltage	Hz/V	3~/50/400										

# Air cooled screw condensing unit, standard efficiency, low sound



ERAD-E-SS/SL

MicroTech III



› More information  
about ERAD-E-SL

<b>Cooling only</b>				<b>ERAD-E-SL</b>	<b>120</b>	<b>140</b>	<b>160</b>	<b>190</b>	<b>210</b>	<b>240</b>	<b>300</b>	<b>350</b>	<b>410</b>	<b>460</b>	
Cooling capacity	Nom.			kW	116	137	159	187	209	243	298	352	409	462	
Power input	Cooling	Nom.		kW	42,4	52,5	57,7	66,3	73,9	78,1	91,9	122	150	167	
Capacity control	Method	Stepless													
	Minimum capacity	25,0													
EER					2,74	2,61	2,75	2,83		3,11	3,24	2,88	2,73	2,76	
Dimensions	Unit	Height			2.273							2.223			
		Width			1.292							2.236			
		Depth			2.165			3.065			3.965			3.070	
					1.684		1.841		2.036		2.789				
Weight	Unit			1.717				1.881		2.081		2.886			
	Operation weight			1.717				1.881		2.081		2.886			
Air heat exchanger	Type	High efficiency fin and tube type with integral subcooler													
Compressor	Type	Driven vapour compression													
	Quantity	1													
Fan	Type	Direct propeller													
	Air flow rate	Nom.			8.373	8.144	12.560	12.216	16.747	16.288	25.120		24.432		
	Quantity			2		3		4		6					
	Speed	Cooling	Nom.	700											
Sound power level	Cooling	Nom.		89		90		91		92		93			
Sound pressure level	Cooling	Nom.		71				73				74			
Operation range	Saturated suction temp				-9~12										
	Condenser inlet temp				-18~48										
Refrigerant	Type / GWP	R-134a / 1.430													
	Circuits	Quantity		1											
Piping connections	Evaporator water inlet/outlet (OD)					76						139,7			
Unit	Maximum starting current			151		195		288		330		410			
	Nominal running current (RLA)	Cooling		73		90		98		112		125		131	
	Maximum running current			83		100		115		128		151		158	
	Phase/Frequency/Voltage			3~/50/400											

## Options - Air cooled chillers

### Options - Small chillers

Chiller series	Integrated hydronics		LWE		Electrical
	Single pump	High Glycol	Low Glycol	Evaporator heater tape	
	OPSP	OPZH	OPZL	OP10	
EWAQ-BVP	STD				OPTION
EWYQ-BVP	STD				OPTION
EWAQ-ACV3	STD				OPTION
EWAQ-ACW1	STD				OPTION
EWYQ-ACV3	STD				OPTION
EWYQ-ACW1	STD				OPTION
EWWQ-KBW1N		Option		Option	
EWLQ-KBW1N		Option		Option	

(1) Impossible option combination: OPZH+OPZL

### Options - Medium and large chillers (Part 1)

Description	Code	EWAQ--CAW EWYQ--CAW	EWAD-CF	EWAQ-G-	EWAD-CZ	EWAD-TZ B
Total heat recovery	01			Option	Option	Option
Total heat recovery (1 circuit)	02			Option		
Partial heat recovery	03				Option	Option
Evaporator 1 Pass	03b					
Direct on line starter (DOL)	04			STD		
WyeDelta compressor starter (YD)	05		STD			
Soft starter	06		Option	Option		
Heat pump version	07					
Heat pump version (including pursuit mode)	07a					
Brine version	08 (1)	Option	Option	Option	Option	
Low temperature brine	08d (1)					
Brine version (on-off fans)	08e (1)					Option
Brine version (inverter fans)	08f (1)					Option
Brine version (brushless fans)	08g (1)					
Double setpoint	10		STD	STD	Option	STD
Compressor thermal overload relays	11		Option		STD	STD
Fans thermal relays	12					
Phase monitor	13		STD		STD	STD
Inverter compressor starter	14				STD	STD
Under / Over voltage control	15		Option		Option	STD
Control expansion pack ( including under/ ver voltage control, setpoint reset, demand limit, alarm from external device, expansion card POL965)	15a			Option		
Energy meter	16		Option		Option	
Energy meter (including current limit)	16a					Option
Capacitors for power factor correction	17		Option	Option		
Capacitors for power factor correction (single-V)	17b					
Current limit	19		Option		Option	
Evaporator viciaulic kit	20			STD	STD	STD
Evaporator flange kit	21		STD		Option	Option
Condenser double flanges kit	26					
20mm evaporator insulation	29		STD	STD	STD	STD
20mm condenser insulation	33					
Condenser viciaulic kit	36					
Speedtrol (fan speed control device ON/OFF up to -18°C)	42				Option	Option
Condenser coil guards	43		Option		Option	
Evaporator area guards	44		Option		Option	
CuCu condenser coil	45		Option		Option	
CuCuSn condenser coil	46		Option		Option	
Alucoat fins coil	49		Option		Option	
Evaporator electric heater	57	Option	STD	STD	STD	STD
Evaporator flow switch	58		Option	Option	Option	Option
Flow switch	58a					
Electronic expansion valve	60		STD		STD	STD
Discharge line shutoff valve	61		STD		STD	STD
Suction line shutoff valve	62		Option		Option	STD

CF = Contact the Factory - NA = Not available - STD = Standard - SO = Specify at Order entry

Please check with the price list the option availability for each size and efficiency/sound version

(1) Option 08 includes option 29

(2) Option 99(a) includes 'Fan overload protection'

(3) Piping between the inertial tank and the unit is not included. Electric heater power supply has to be provided from external source

(4) Inverter kit can not be ordered without selecting the correspondent water pump option

(5) Option 143 can not be ordered without selecting the correspondent Inverter pump kit

(6) Operation starting from 46°C

(7) Option will have impact on unit performance; contact factory for more information

(8) Option 171 includes 61; 62; 99; 99a

(9) Option 172 includes 61; 99; 99a

(10) Option 173 includes 61; 99; 99a

(11) EWYQ-F: Includes Setpoint reset, Demand limit, Alarm from external device and Pump control contacts - Opt. 90a is already included ordering option: 13 or 15 or 42 or 78 or 80 or 102



## Options - Medium and large chillers (Part 1)

	<b>EWAH-TZ B</b>	<b>EWAD-T</b>	<b>EWAT-B</b>	<b>EWYQ-G-</b>	<b>EWYQ-F</b>	<b>EWYD-BZ</b>	<b>EWYD-4Z</b>	<b>ERAD-E</b>
	Option	Option	Option					Option
	Option	Option	Option	Option	Option	Option	Option	Option
			STD	STD	STD			
		STD Option	Option	Option	Option			STD Option
		Option	Option	Option	Option	Option	Option	
	Option							
	STD STD	STD Option	STD Option	STD	STD Option	STD	STD STD	STD Option
	STD STD STD	STD Option	Option		Option Option	STD STD Option	STD STD STD	STD Option
				Option				
		Option	Option		Option	Option		Option
	Option	Option	Option Option	Option	Option		Option	Option
		Option STD Option	STD Option	STD	STD	Option STD	STD Option Option STD STD STD	Option
		STD	Option	STD	STD	Option		
	Option	Option	Option		Option			Option Option
					Option Option Option	Option Option	Option Option	Option Option
	STD Option	Option Option	STD Option	STD Option	STD STD STD	Option STD Option	STD STD	Option
							Option	
	STD STD STD	STD STD Option	STD Option Option	STD	STD Option	STD STD STD	STD STD Option	STD STD

Options - Medium and large chillers (Part 2)

Description	Code	EWAQ~CAW EWYQ~CAW	EWAD-CF	EWAQ-G-	EWAD-CZ	EWAD-TZ B	EWAH-TZ B
High pressure side manometers	63		Option		Option	Option	Option
Low pressure side manometers	64		Option		Option	Option	Option
Ambient outside temperature sensor and setpoint reset	67		STD	STD	STD	STD	Option
Hour run meter	68		STD	STD	STD	STD	Option
General fault contactor	69		STD	STD	STD	STD	Option
Alarm from external device	70						
Container Kit	71			Option	Option	Option	Option
Rubber anti vibration mounts	75		Option	Option	Option	Option	Option
Sound proof system	76						
Sound proof system (integral)	76-a						
Sound proof system (compressor)	76-b						
Spring anti vibration mounts	77		Option	Option	Option	Option	Option
One centrifugal pump (low lift)	78	Option		Option	Option	Option	Option
One centrifugal pump --- SPK1	78-a		Option		Option		
One centrifugal pump --- SPK2	78-b		Option		Option		
One centrifugal pump --- SPK3	78-c				Option		
One centrifugal pump --- SPK4	78-d						
One centrifugal pump --- SPK5	78-e						
One centrifugal pump --- SPK8	78-h						
One centrifugal pump --- SPK9	78-i						
One centrifugal pump (high lift)	79	Option		Option		Option	Option
Two centrifugal pump (low lift)	80			Option		Option	Option
Two centrifugal pump --- DPK2	80-b				Option		
Two centrifugal pump --- DPK3	80-c				Option		
Two centrifugal pump --- DPK4	80-d				Option		
Two centrifugal pump --- DPK5	80-e						
Two centrifugal pump (high lift)	81			Option		Option	Option
External tank without cabinet (500 L)	83 (3)			Option		Option	Option
External tank without cabinet (1000 L)	84 (3)			Option		Option	Option
External tank with cabinet (500 L)	87 (3)			Option		Option	Option
External tank with cabinet (1000 L)	88 (3)			Option		Option	Option
Setpoint reset, Demand limit and Alarm from external device	90		STD		STD	STD	STD
Control expansion pack POL965	90a (11)						
Double pressure relief valve with diverter	91		Option	Option	Option	Option	Option
Compressors circuit breakers	95		Option	Option	Option	Option	Option
Fans circuit breakers	96		STD	Option	STD	STD	STD
Main switch interlock door	97		STD	STD	STD	STD	STD
Emergency stop	98		STD		STD		
Fans speed regulation (+ fan silent mode)	99 (2)		STD		Option		
Fans speed regulation (inverter)	99a (2)						
Refrigerant recovery unit	100				CF	Option	Option
Evaporator right water connections	101		SO		SO	SO	SO
Ground fault relay	102		Option		Option	Option	Option
Rapid restart	110		Option		Option		Option
High temperature kit	111						
Transport kit	112			Option	Option	Option	Option
Optimized free cooling (VFD fans regulation)	113-a		Option				
Optimized free cooling (On/Off fans)	113-b		Option				
Nordic kit	114						
Water filter	115			Option		STD	STD
Condenser coil protection panels	116		Option		Option		
Blygold coil treatment	117		Option		Option		
Inverter kit for 1 centr pump low lift	120e (4)			Option		Option	Option
Inverter kit for 1 centr pump high lift	120f (4)			Option		Option	Option
Inverter kit for 2 centr pumps low lift	120g (4)					Option	Option
Inverter kit for 2 centr pumps high lift	120h (4)					Option	Option
Inverter kit for 1 centr pump low lift (FC)	120E-FC						
Inverter kit for 1 centr pump high lift (FC)	120F-FC						
Inverter kit for 2 centr pump low lift (FC)	120G-FC						
Inverter kit for 2 centr pump high lif (FC)	120H-FC						
Refrigerant leak detection	121						
Discharge and suction line shut-off valve	126			Option			
High and low pressure side manometers	127			Option			
Master/slave	128			STD		STD	STD
One centrifugal pump (low lift) + tank	134			Option			
One centrifugal pump (high lift) + tank	135			Option			
Two centrifugal pump (low lift) + tank	136			Option			
Two centrifugal pump (high lift) + tank	137			Option			
Coil guard	138			Option			
E-coating microchannel coils	139			Option			
Unit guards (to cover unit access)	140					Option	Option
Side panels on coil ends	141					Option	Option
High ambient kit (operating 46°C)	142 (6)						
High ambient kit	142a (6)						
High ambient kit (operation above 46°C on-off fans)	142b (6)						
High ambient kit (operation above 46°C Brushless fans)	142c (6)					Option	Option
Variable primary flow	143 (5)					Option	Option
Diff pressure transd (shipped loose)	144					Option	Option
Blue coat	153					Option	Option
Evaporator Optimized for high delta T	154 (7)					Option	Option
Daikin on site modem (with antenna)	155				Option	Option	Option
AC 9000 rpm fans	156					STD	
AC 700 rpm fans	157					STD	STD
Brushless fans up to 900 rpm	158 (7)					Option	
Brushless fans up to 700 rpm	159 (7)					Option	Option
100 PA ESP fans	160			Option			
100 Pa ESP (on-off fans)	160a (7)					Option	Option
100 Pa ESP (on-off high power fans)	160d (7)					Option	
200 PA ESP fans	161						
200 Pa ESP (on-off high power fans)	161a (7)					Option	Option
200 Pa ESP (brushless fans)	161b (7)					Option	
Cu-Ni Evaporator tubes	164					CF	CF
120 Pa ESP fans	168						
Free cooling migration - Light	171 (8)						
Free cooling migration - Full	172 (9)						
Free cooling migration - Full with hydro kit	173 (10)						



## Accessories - Air cooled chillers

Panels	Air-cooled chillers							
	EWAQ~BVP EWYQ~BVP	EWAQ~AC EWYQ~AC	EWAQ~CAW EWYQ~CAW	EWAD-CF	EWAQ-G-	EWAD-CZ	EWAD-TZ B	
EKDICMPAB (a) (b) iCM Primary Basic					•	•	•	
EKDICMPAL (a) (b) iCM Primary for evaporator peripherals Light				•(c)	•	•	•	
EKDICMPAF (a) (b) iCM Primary for evaporator peripherals Full				•(c)	•	•	•	
EKTSMS Temperature sensor for master/slave configuration				•(c)	•			
EKRUMCL1 User Interface	•							

Serial Cards & Communication Modules	Air-cooled chillers							
	EWAQ~BVP EWYQ~BVP	EWAQ~AC EWYQ~AC	EWAQ~CAW EWYQ~CAW	EWAD-CF	EWAQ-G-	EWAD-CZ	EWAD-TZ B	
EKAC200J Serial Card RS485/Modbus								
EKACBAC Ethernet Card BACnet								
EKACLONP Serial Card LON FTT10								
EKACRS232 Serial Card RS232 Modem Interface (single unit only)								
EKACWEB Web Server Card								
EKACBACMSTP Serial Card BACnet MSTP								
EKACBACCERT Serial Card BACnet pre-loaded (centrifugal chillers)								
EKACMSTPCERT Serial Card BACnet pre-loaded MSTP (centrifugal chillers)								
EKCM200J ModBus RTU communication module				•	•	•	•	
EKCMLON LON communication module				•	•	•	•	
EKCBACMSTP BACnet/MSTP communication module				•	•	•	•	
EKCBACIP BACnet/IP communication module				•	•	•	•	

Other Systems & Accessories	Air-cooled chillers							
	EWAQ~BVP EWYQ~BVP	EWAQ~AC EWYQ~AC	EWAQ~CAW EWYQ~CAW	EWAD-CF	EWAQ-G-	EWAD-CZ	EWAD-TZ B	
EKCON Converter RS485 to RS232								
EKCONUSB Converter RS485 to USB								
EKMODEM Fixed modem								
EKGSMOD GSM modem								
EKRUPCJ Remote display kit								
EKRUPCS Local/remote display HMI				•	•	•	•	
EKPWPROEXT PlantWatchPro I/O extension module for hardwiring and retrofit								
EKGWWEB Gateway web (Ethernet LAN SNMP)								
EKGWMODEM Gateway for modem								
EKAC10C Address card for connection to BMS or Remote user interface								
EKRUMCA Remote installed user interface								
EKLS2 (d) Low noise kit 22/28/35/45/55/65 Hp-units								
ECB2MUBW (e) Controller kit								
ECB2MUBW (e) Controller kit								
EKRP1AHT (g) Digital input/output PCB			•					
EKRUAHTB (g) Remote user interface			•					
DTA104A62 (f) External control adapter			•					
BHGP26A1 (f) Digital pressure gauge kit			•					
EKQDP2M016 (g) Differential Pressure Sensor 4-20 mA 0-160 kPa				•	•	•	•	
EKQDP2M020 (g) Differential Pressure Sensor 4-20 mA 0-250 kPa				•	•	•	•	
EKQDP2M040 (g) Differential Pressure Sensor 4-20 mA 0-400 kPa				•	•	•	•	
EKQDP2M060 (g) Differential Pressure Sensor 4-20 mA 0-600 kPa				•	•	•	•	
EKDAPCONT Containerization of one unit				•	•	•	•	
EKDAPSTF Containerization of additional units in the same container				•	•	•	•	

Notes:

- (a) Price **does not** include commissioning of panel; if commissioning is required please refer to RN17-041
- (b) iCM panels work in **cooling mode only**; heat pump versions and total heat recovery options on A/C and W/C chillers **are not compatible**
- (c) in case you are ordering iCM panels please **contact factory**
- (d) For 45/55/65 Hp-units 2 pieces are needed
- (e) Only available for modulare units (EWWQ~KAW1M)
- (f) Price available in SAP system
- (g) Differential pressure sensor are specific for iCM panels in variable primary flow management

	EWAH-TZ B	EWAD-T	EWAT-B	EWYQ-G-	EWYQ-F	EWYD-BZ	EWYD-4Z	ERAD-E
	•	•	•					
	•	•	•					
	•	•	•					
			•	•	•			

	EWAH-TZ B	EWAD-T	EWAT-B	EWYQ-G-	EWYQ-F	EWYD-BZ	EWYD-4Z	ERAD-E
						•		
						•		
						•		
						•		
						•		
						•		
						•		
						•		
	•	•	•	•	•		•	•
	•	•	•	•	•		•	•
	•	•	•	•	•		•	•
	•	•	•	•	•		•	•

	EWAH-TZ B	EWAD-T	EWAT-B	EWYQ-G-	EWYQ-F	EWYD-BZ	EWYD-4Z	ERAD-E
						•		
						•		
						•		
						•		
						•		
						•		
						•		
						•		
						•		
	•	•	•	•	•		•	•
	•	•	•	•	•		•	•
	•	•	•	•	•		•	•
	•	•	•	•	•		•	•
	•	•	•	•	•		•	•
	•	•	•	•	•		•	•
	•	•	•	•	•		•	•





## Why choose for a water cooled chiller?

Daikin's efficient, profitable and maintenance-friendly water cooled chillers are especially suitable for critical industrial applications where a temperature control accuracy of  $\pm 0.5^{\circ}\text{C}$  is required. Water cooled chillers are typically intended for indoor installation and operation. Water cooled chillers are available with different compressor types:

### Water cooled scroll chillers

These units are among the most efficient, quiet and reliable chillers available today. Units can be easily integrated with the HVAC system of your choice.

### Water cooled screw chillers

The Daikin water cooled screw chillers provide the ideal solution for sound sensitive environments. Applications range from comfort cooling to ice making.

### Water cooled centrifugal chillers

Small footprint, quiet compressor, easy integration with existing HVAC system... This chiller offers you a return on investment throughout its life cycle. Ideal solution for large cooling requirements (e.g. district cooling).

### Large product line-up

Thanks to an extensive product line-up in medium- to large-scale facilities (from 13 kW up to 10,900 kW), you can select the optimum model for your application.

### Application versatility

Daikin delivers energy efficiency to a wide range of process and comfort climate applications, for all conditions and cooling or heating requirements. These chillers generate cold and hot water, which can be used for chilling, heating or even both at the same time.

### Outstanding durability

The latest technology for magnetic bearings is used in the compressor, the heart of the centrifugal chiller. Result? Outstanding durability for lower maintenance costs.

### Installation flexibility

Water cooled chillers can be installed indoors and require only very limited space in a machine room.

# Table of content

# Water cooled

## Cooling & Heating only

---

EWQW-KBW1N	104
EWQW-G-SS	106
EWQW-G-SS	107
EWQW-L-SS	108
EWQW-J-SS	109

## Cooling only

---

EWQW-VZSS	112
EWQW-VZXS	113
EWQW-VZPS	114
<b>NEW</b> EWQW-VZSS	117
EWQW-VZXS	118
EWQW-VZPS	119

## Centrifugal chillers

---

<b>NEW</b> EWQW-DZXS	124
EWQW-DZXE	125
EWQW-DZXS	126
EWQW-DZXE	127
DWDC/DWSC	128

Options	130
Accessories	132

---

# Water cooled scroll heat pump

- › One of the most compact units on the market: 600mm x 600mm x 600mm
- › Low energy consumption
- › Low operating sound level
- › Low refrigerant volume
- › Stainless steel plate heat exchanger
- › Extension possible to 183kW
- › Easy installation and maintenance
- › Remote cooling or heating selection
- › Water/water heat pump, with water reversibility
- › Standard integrated: water filter, flow switch, air purge, pressure ports
- › Advanced  $\mu\text{C}^2\text{SE}$  controller for direct connection to a Modbus based BMS or to a remote user interface



› More information about EWWQ-KBW1N

Cooling only/Heating only				EWWQ-KBW1N	014	025	033	049	064	098	113	128	147	162	177	192	
Cooling capacity	Nom.			kW	13,25	23,9	30,4	47,15	60,98	94	108	122	142	155	169	183	
Power input	Cooling	Nom.		kW	3,15	5,72	7,3	11,42	14,58	22,7	25,8	28,9	33,9	37	40,1	43,2	
Capacity control	Minimum capacity			%	100			50			25			16			
EER					4,209	4,177	4,164	4,127	4,182	4,17	4,19	4,22	4,18	4,2	4,22	4,24	
IPLV					5,13	5,27	5,41	5,36	5,47	5,36	5,42	5,47	5,36	5,4	5,44	5,47	
Dimensions	Unit	Height	mm	600			600			1.200			1.800				
		Width	mm				600										
		Depth	mm	600						1.200							
Weight	Unit			kg	120	170	175	310	340	620	650	680	930	960	990	1.020	
		Operation weight		kg	123	175	182	320	353	640	673	707	960	993	1.026	1.060	
Water heat exchanger - evaporator	Type				Braze plate												
	Water volume			l	1,23	1,93	2,68	4,5	5,93	9	10	12	14	15	16	18	
	Water flow rate	Nom.		l/s	0,64	1,15	1,46	2,26	2,92	4,5	5,2	5,8	6,8	7,4	8,1	8,8	
	Water pressure drop	Cooling	Nom.		kPa	19,6	28,5	25,7	24,3	25,3	24,3	25,2	24,3	24,3	25,2		
Water heat exchanger - condenser	Type				Braze plate												
	Water volume			l	1,83	2,93	4,03	5,45	7,35	10,9	12,8	14,69	16,35	18,25	20,15	22,04	
	Water flow rate	Nom.		l/s	0,78	1,41	1,83	2,78	3,61	5,57	6,39	7,21	8,35	9,17	10	10,8	
	Water pressure drop	Cooling	Nom.		kPa	13,2	18,3	18,5	26,9	28,5	26,9	28,5	26,9	26,9	28,5		
Compressor	Type				Driven vapour compression												
	Quantity				1			2			4			6			
Sound power level	Cooling	Nom.		dBA	64		71	67	74	71	75	77	73	77	78	79	
Sound pressure level	Cooling	Nom.		dBA	50		57	53	60	55,70	59,70	61,70	56,9	60,9	61,9	62,9	
Operation range	Evaporator	Cooling	Min.~Max.		-10~20												
	Condenser	Cooling	Min.~Max.		20~55												
Refrigerant	Type				R-410A												
	Charge			kg	1,2	2	3,1	4,6	5,6	9,4	10,2	11,2	13,8	14,8	15,8	16,8	
	Circuits	Quantity			1			2			4			6			
Piping connections	Evaporator water inlet/outlet (OD)				G1"			G1" 1/2			2 x 2x G1" 1/2			3 x 3x G1" 1/2			
	Condenser water inlet/outlet (OD)				G1"			G1" 1/2			2 x 2x G1" 1/2			3 x 3x G1" 1/2			
Unit	Starting current	Max		A	61,8	101,9	137,9	117,55	158,63	148,86	189,93	200,09	180,16	221,24	231,39	241,54	
	Running current	Cooling	Nom.		A	5,99	9,29	12,98	18,69	26,08	37,37	44,75	52,12	56,06	63,44	70,81	78,18
		Max			A	9,47	15,65	20,73	31,31	41,46	62,61	72,76	82,91	93,92	104,07	114,22	124,37
Power supply	Phase/Frequency/Voltage			Hz/V	3~/50/400												



# Water cooled scroll chiller

## Combination table

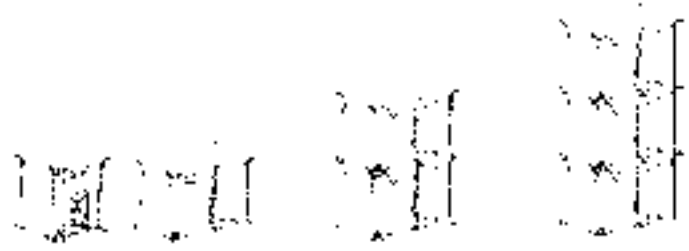

		Single Module					2 x Modules			3 x Modules			
Unit Index		014	025	033	049	064	098	113	128	147	162	177	192
Capacity (kW)		13	24	31	49	64	98	113	128	147	162	177	192
Unit + control factory mounted	EWQ014KBW1N	1	-	-	-	-	-	-	-	-	-	-	-
	EWQ025KBW1N	-	1	-	-	-	-	-	-	-	-	-	-
	EWQ033KBW1N	-	-	1	-	-	-	-	-	-	-	-	-
	EWQ049KBW1N	-	-	-	1	-	-	-	-	-	-	-	-
	EWQ064KBW1N	-	-	-	-	1	-	-	-	-	-	-	-
Modular unit (controller available as accessory)	EWQ049KAW1M	-	-	-	-	-	2	1	-	3	2	1	-
	EWQ064KAW1M	-	-	-	-	-	-	1	2	-	1	2	3
Controller for modular unit	ECB2MUAW	-	-	-	-	-	1	1	1	-	-	-	-
	ECB3MUAW	-	-	-	-	-	-	-	-	1	1	1	1

Note 1: the above combination table is also valid for standard models with OPZL or OPZH.

Note 2: condenserless versions are only available as single modules only.



# Water cooled multi-scroll chiller reversing on refrigerant side, standard efficiency, standard sound

- › Single refrigerant circuit (2 scroll compressors) with single evaporator
- › Heat pump version with reversibility on refrigerant side available, ideal for geothermal applications
- › Compact design to allow easy indoor installation or retrofit operations
- › Conceived for stacked installation of two single circuit units to reduce the footprint
- › High efficiency and reliable scroll compressor
- › High flexibility for a wide variety of applications
- › Allows sequencing control (up to 4 units) without any external device
- › Stainless steel plate heat exchanger
- › Pump (low 100 kPa and high 200 kPa lift) available for evaporator and condenser
- › MicroTech III controller with superior control logic and easy interface



› More information about EWHQ-G-SS

Heating & Cooling				EWHQ-G-SS															
				100	120	130	150	160	190	210	240	270	340	400					
Cooling capacity	Nom.	kW		87,3	100,0	111	127	141	160	181	208	232	291	352					
Heating capacity	Nom.	kW		112	128	144	162	179	205	233	266	299	375	454					
Capacity control	Method			Step															
	Minimum capacity			%	50,0	43,0	50,0	44,0	50,0	45,0	50,0	43,0	50,0	40,0	50,0				
Power input	Cooling	Nom.	kW	22,4	25,3	28,5	32,0	35,6	41,1	46,0	53,3	59,1	73,7	88,4					
	Heating	Nom.	kW	27,0	30,9	35,2	39,3	43,6	50,4	56,6	64,7	72,2	90,3	109					
EER				3,90	3,95	3,91	3,96	3,95	3,90	3,93	3,90	3,92	3,95	3,98					
COP				4,15	4,16	4,09	4,12	4,11	4,07	4,11	4,10	4,14	4,16	4,18					
IPLV				6,02	6,14	5,66	5,84	5,73	5,84	5,81	5,87	5,71	5,86	5,79					
Dimensions	Unit	HeightxWidthxDepth		mm				1.066x928x2.432				1.186x928x2.432							
Weight	Unit			kg				808				941							
	Operation weight				kg				908				1.031						
Water heat exchanger - evaporator	Type			Plate heat exchanger															
	Water volume			l		6	8	10	12	13	15	17	27	34					
	Water flow rate	Cooling	Nom.	l/s	4,2	4,8	5,3	6,1	6,7	7,7	8,7	10,0	11,1	13,9	16,9				
		Heating	Nom.	l/s	4,1	4,7	5,2	5,9	6,5	7,4	8,5	9,6	10,9	13,7	16,6				
	Water pressure drop	Cooling	Nom.	kPa	44		35	30	29	31	33	31	38	42	43				
Heating		Nom.	kPa	42		33	28	27	29	32	29	37	41	42					
Water heat exchanger - condenser	Type			Plate heat exchanger															
	Water volume			l		6	8	10	12	13	15	17	27	34					
	Water flow rate	Cooling	Nom.	l/s	5,2	6,0	6,7	7,7	8,5	9,7	10,9	13,7	13,9	17,4	21,1				
		Heating	Nom.	l/s	5,4	6,2	7,0	7,8	8,7	9,9	11,2	12,5	14,3	18,0	21,8				
	Water pressure drop	Cooling	Nom.	kPa	69		55	49	48	51	54	32	39	66	69				
Heating		Nom.	kPa	73		59	51	50	53	57	33	42	70	73					
Compressor	Type			Driven vapour compression															
	Quantity			2															
Sound power level	Cooling	Nom.	dB(A)	80	83	85	87	88				90	92	93					
	Heating	Nom.	dB(A)	64	67	69	70	72				74	76	77					
Operation range	Evaporator	Cooling	Min.~Max.	°CDB		-8~-15													
		Heating	Min.~Max.	°CDB		-8~-15													
	Condenser	Cooling	Min.~Max.	°CDB		25~55													
		Heating	Min.~Max.	°CDB		25~55													
Refrigerant	Type/GWP			R-410A/2.087,5															
	Circuits			Quantity		1													
Refrigerant charge				kg/TCO,Eq		9,0/18,8		10,0/20,9		13,0/27,1		11,0/23,0		13,0/27,1		15,0/31,3		19,0/39,7	
Piping connections	Evaporator water inlet/outlet (OD)			1" 1/2						2" 1/2						3"			
	Condenser water inlet/outlet (OD)			1" 1/2						2" 1/2						3"			
Power supply	Phase/Frequency/Voltage			Hz/V		3~/50/400													
Unit	Starting current	Max		A		204	255	261	308	316	354	368	466	481	640	677			
		Running current	Cooling	Nom.	A	43	46	50	56	63	71	78	88	97	123	148			
	Max		A		59	66	72	80	88	102	116	131	145	183	221				

# Water cooled multi-scroll chiller, standard efficiency, standard sound

- › Single refrigerant circuit (2 scroll compressors) with single evaporator
- › Heat pump version available
- › Compact design to allow easy indoor installation or retrofit operations
- › Conceived for stacked installation of two single circuit units to reduce the footprint
- › High efficiency and reliable scroll compressor
- › High flexibility for a wide variety of applications
- › Allows sequencing control (up to 4 units) without any external device
- › Stainless steel plate heat exchanger
- › Pump (low 100 kPa and high 200 kPa lift) available for evaporator and condenser
- › MicroTech III controller with superior control logic and easy interface



EWVQ-G-SS

MicroTech III



› More information about EVVQ-G-SS

Cooling Only				EWVQ-G-SS	090	100	120	130	150	170	190	210	240	300	360	
Space cooling	A Condition 35°C Pdc			kW	93,7	105,6	119	135,9	150	172,1	193,8	220,7	246,1	314,3	370,4	
	ηs,c			%	209,08	215,32	233,52	227,68	233,04	233,36	220,32	235,56	231,84	236,64	211,36	
SEER					5,427	5,583	6,038	5,892	6,026	6,034	5,708	6,089	5,996	6,116	5,484	
Cooling capacity	Nom.			kW	93,7	105,6	119	135,9	150	172,1	193,8	220,7	246,1	314,3	370,4	
Power input	Cooling	Nom.		kW	21,3	24	26,9	30,5	33,9	38,9	43,8	50,74	56,1	70,2	84	
Capacity control	Method			Fixed												
	Minimum capacity			%	50	43	50	44	50	45	50	43	50	40	50	
EER					4,399	4,4	4,424	4,456	4,425	4,424	4,425	4,349	4,387	4,477	4,41	
IPLV					6,71	6,79	6,22	6,36	6,22	6,32	6,3	6,31	6,1	6,28	6,16	
Dimensions	Unit	Height	mm	1.066												
		Width	mm	928												
		Depth	mm	2.432				2.264				2.432				
Weight	Unit			kg	516	606	728	762	795	832	871	921	934	1.083	1.181	
	Operation weight			kg	554,9	652,4	781,6	821,4	859	901,4	945,9	1.009,6	1.023,2	1.194,7	1.311,1	
Water heat exchanger - evaporator	Type			Plate heat exchanger												
	Water volume			l	6	8		10	12	13	15	17		27	34	
	Water flow rate	Nom.		l/s	4,5	5,07	5,7	6,51	7,18	8,24	9,28	10,57	11,79	15,06	17,74	
Water heat exchanger - condenser	Type			Plate heat exchanger												
	Water volume			l	6	8		10	12	13	15	17		27	34	
Compressor	Type			Driven vapour compression												
	Quantity				2											
Sound power level	Cooling	Nom.		dB(A)	80	83	85	87	88			90	92	93		
Sound pressure level	Cooling	Nom.		dB(A)	64	67	69	70	72			74	76		77	
Operation range	Evaporator	Cooling	Min.~Max.	°CDB	-10~-15											
		Heating	Min.~Max.	°CDB	-10~-15											
	Condenser	Cooling	Min.~Max.	°CDB	25~55											
		Heating	Min.~Max.	°CDB	25~55											
Refrigerant	Type/GWP			R-410A/2.087,5												
	Charge			kg	10	11		12	15	16	17	19	20			
	Circuits			Quantity	1											
Refrigerant charge				TCO <sub>2</sub> Eq	20,88	22,96		25,05	31,31	33,40	35,49	39,66	41,75			
Piping connections	Evaporator water inlet/outlet (OD)				1" 1/2				2" 1/2				3"			
	Condenser water inlet/outlet (OD)				1" 1/2				2" 1/2				3"			
Unit	Starting current			Max	A	204	255	261	308	316	354	368	466	481	640	677
	Running current	Cooling	Nom.	A	42	45	48	54	61	68	76	86	95	118	143	
		Max		A	59	66	72	80	88	102	116	131	145	183	221	
Power supply	Phase/Frequency/Voltage			Hz/V	3~/50/400											

# Water cooled multi-scroll chiller, standard efficiency, standard sound

- › Dual refrigerant circuit (4 scroll compressors) with single evaporator
- › Heat pump version available
- › Compact design to allow easy indoor installation or retrofit operations
- › High efficiency and reliable scroll compressor
- › Stainless steel plate heat exchanger
- › High flexibility for a wide variety of applications
- › Allows sequencing control (up to 4 units) without any external device
- › Pump (low 100 kPa and high 200 kPa lift) available for evaporator and condenser
- › MicroTech III controller with superior control logic and easy interface



› More information about EWWQ-L-SS

Cooling only/Heating only				EWWQ-L-SS														
				180	205	230	260	290	330	380	430	480	540	600	660	720		
Space cooling	A Condition 35°C	Pdc	kW	187,4	215,1	244,3	272,6	303,2	344,5	386,8	430,2	475,6	548,8	610,9	663	721		
	ηs,c			%	211,72	222,72	232,76	230,32	236,76	233,32	224,84	239,12	230,6	235,92	236,2	228	228,4	
SEER				5,493	5,768	6,019	5,958	6,119	6,033	5,821	6,178	5,965	6,098	6,105	5,9	5,91		
Cooling capacity	Nom.		kW	187,4	215,1	244,3	272,6	303,2	344,5	386,8	430,2	475,6	548,8	610,9	663	721		
Power input	Cooling	Nom.	kW	41,7	47,3	53,1	60,2	67,1	77,1	87	97,9	109,5	123,5	139,7	153,8	166,9		
				Capacity control	Method	Fixed												
				Minimum capacity	%	25	21	25	22	25	23	25	21	25	22	20	18	25
EER				4,494	4,548	4,601	4,528	4,519	4,468	4,446	4,394	4,343	4,444	4,373	4,311	4,32		
IPLV				6,77	6,84	6,35	6,38	6,31	6,32	6,36	6,37	6,16	6,29	6,23	6,2	6,18		
Dimensions	Unit	Height	mm	1.970														
		Width	mm	928														
		Depth	mm	2.801														
Weight	Unit		kg	877	1.062	1.285	1.347	1.439	1.498	1.559	1.673	1.722	1.842	1.926	2.105	2.229		
	Operation weight		kg	957	1.156	1.401	1.469	1.575	1.641	1.723	1.851	1.918	2.044	2.145	2.346	2.405		
Water heat exchanger - evaporator	Type			Plate heat exchanger														
	Water volume		l	35	41	53		65	76		92			115				
	Water flow rate	Nom.	l/s	8,97	10,29	11,69	13,04	14,5	16,48	18,51	20,58	22,77	26,29	29,26	31,77	34,57		
Water heat exchanger - condenser	Type	Cooling	Nom.	kPa	28	27,6	22,6	28	25,1	32,2	31,9	32,8	40,4	51,4	49,5	59,1	69,4	
					Water volume	l	19	22	29		35	41		49		62		
					Water flow rate	Nom.	l/s	11,02	12,66	14,4	16,12	17,9	20,38	22,8	25,4	28,08	32,3	36,02
Compressor	Type	Quantity		kPa	72	73	61	49	50	51	55	46	57	66	67	68		
					Driven vapour compression													
					4													
Sound power level	Cooling	Nom.	dB(A)	83	86	88	90		91		93		95		96			
				Sound pressure level	Nom.	dB(A)	65	68	70	72		74		73		76		77
Operation range	Evaporator	Cooling	Min.~Max.	°CDB	-10~15													
		Heating	Min.~Max.	°CDB	-10~15													
	Condenser	Cooling	Min.~Max.	°CDB	25~55													
		Heating	Min.~Max.	°CDB	25~55													
Refrigerant	Type/GWP			R-410A/2.087,5														
	Charge		kg	20		22		24		30	32		34		38		40	
	Circuits	Quantity		2														
Refrigerant charge			kg/TCO2Eq	10,0/20,9		11,0/23,0		12,0/25,1		15,0/31,3	16,0/33,4		17,0/35,5		19,0/39,7		20,0/41,8	
Piping connections	Evaporator water inlet/outlet (OD)			3"														
	Condenser water inlet/outlet (OD)			1" 1/2				2" 1/2				3"						
	Unit	Starting current	Max	A	263	320	333	388	403	456	484	597	626	785	822	860	898	
Running current		Cooling	Nom.	A	83	89	96	109	121	137	151	171	189	210	236	260	284	
Running current		Max	A	118	131	144	160	175	205	232	262	290	328	366	403	441		
Power supply	Phase/Frequency/Voltage			Hz/V 3~/50/400														

# Water cooled screw chiller, standard efficiency, standard sound

- › Compact design to allow easy indoor installation or retrofit operations
- › Daikin semi-hermetic single screw stepless compressor
- › High energy efficiency both at full and part load conditions
- › Chilled water temperatures down to -10°C on standard unit
- › Optimised for use with R-134a
- › MicroTech III controller with superior control logic and easy interface



› More information about EWWD-J-SS

Cooling & Heating				EWWD-J-SS	120	140	150	180	210	250	280
Cooling capacity	Nom.		kW	120	146	154	177	207	255	284	
Heating capacity	Nom.		kW	148	180	194	223	258	315	354	
Capacity control	Method			Stepless							
	Minimum capacity		%	25,0							
Power input	Cooling	Nom.	kW	28,0	34,0	39,5	45,3	50,4	59,9	70,0	
	Heating	Nom.	kW	28,0	34,0	39,5	45,3	50,4	59,9	70,0	
EER				4,28	4,29	3,90	3,91	4,11	4,26	4,06	
COP				5,28	5,29	4,90	4,91	5,11	5,26	5,06	
IPLV				5,18		5,06		5,16	5,70	4,88	
Space heating	Average climate water outlet 35°C	General	ηs (Seasonal space heating efficiency)	168		166	158		162	170	160
		A Condition (7°CDB/-8°CWB)	SCOP	4,40	4,34	4,14	4,15	4,24	4,46	4,21	
		PERd	%	144,7	176,0	190,2	218,3	252,8	309,1	347,8	
		Pdh	kW	5,2		4,8		5,0	5,2	5,0	
Dimensions	Unit	HeightxWidthxDepth		mm							
Weight	Unit			1.020x913x2.684							
	Operation weight			kg	1.177	1.233	1.334	1.366	1.416	1.600	1.607
Water heat exchanger - evaporator	Type			Plate heat exchanger							
	Water volume			l	14	18	14	17	20		26
Water heat exchanger - evaporator	Water flow rate	Nom.	l/s	5,7	7,0	7,4	8,5	9,9	12,2	13,6	
	Water pressure drop	Cooling	Nom.	kPa	15	14	43	40	35	28	34
		Heating	Nom.	kPa	15	14	43	40	35	28	34
Water heat exchanger - condenser	Type			Single pass shell and tube							
	Water volume			l	20		23	25	29		32
	Water flow rate	Nom.	l/s	7,1	8,6	9,3	10,7	12,4	15,2	17,0	
	Water pressure drop	Cooling	Nom.	kPa	19		12		11	16	26
Heating		Nom.	kPa	19		12		11	16	26	
Compressor	Type			Driven vapour compression							
	Quantity			1							
Sound power level	Cooling	Nom.	dB(A)	89							
Sound pressure level	Cooling	Nom.	dB(A)	79							
Operation range	Evaporator	Cooling	Min.~Max.	°CDB -10~15							
	Condenser	Cooling	Min.~Max.	°CDB 23~60							
Refrigerant	Type/GWP			R-134a/1.430							
	Circuits		Quantity	1							
Refrigerant charge			kg/TCO,Eq	18,0/25,7	35,0/50,1	34,0/48,6	37,0/52,9		38,0/54,3		
Piping connections	Evaporator water inlet/outlet (OD)		mm	76,2							
	Condenser water inlet/outlet (OD)			2" 1/2		4"					
Power supply	Phase/Frequency/Voltage		Hz/V	3~/50/400							
Unit	Starting current		Max	A 151							
	Running current	Cooling	Nom.	A	48	57	67	74	83	97	109
		Max	A	76	97	107	122	143	167	189	

# The highest peak in chiller technology

The EWWD-VZ chiller series were developed and manufactured to answer the growing market demands on high efficient chiller series. Thanks to the continuous evolution in components' technology, we are the first to reach the highest peak in chiller efficiency and technology.

## EWWD-VZ at a glance

### Single compressor

450 kW - 1,053 kW



Full inverter water cooled chiller



### Dual compressor & dual circuit unit

1,200 kW - 2,100 kW

2 of everything:  
2 compressors,  
2 expansion valves,  
2 condensers,...



New condenser design with integral oil separator

High efficient flooded heat exchangers

**VZ**  
CHILLER SERIES

Highest efficiency in the market in its category



Unique Daikin single screw compressor technology



# Why choose EWWD-VZ chiller series?

- 1 Top class efficiency: SEER up to 9 – EER up to 5.8**  
Thanks to:
  - New generation Daikin inverter screw compressors
  - New generation high efficiency heat exchangers
  - Variable volume ratio technology
  - Optimized refrigerant circuit design
- 2 Compact unit : 40% footprint reduction**  
Thanks to:
  - New single pass condenser technology
  - New integrated oil separator technology
  - Optional knock down panel which reduces the unit width
- 3 Application flexibility : widest operating envelope in its range**
- 4 Connectivity : Daikin on site cloud platform**
- 5 Future readiness: Choose for today's best solution and be ready for the future!**

## Supporting tools

Product video



Check on

  
[www.youtube.com/  
DaikinEurope](http://www.youtube.com/DaikinEurope)



## Marketing material

All marketing material can be downloaded from the business portal.  
Asset finder > Campaign > VZ chiller series



## Product profile

Want to know more about this product?  
Have a look at our website and download the product profile:

# Water cooled screw inverter chiller, standard efficiency, standard sound

- › Optimized energy efficiency both at full and part load conditions
- › Compact footprint through stacked heat exchanger lay-out
- › Heat pump version with reversibility on water side (up to 65°C hot water production)
- › Multiple options available: sound proof cabinet, rapid restart, removable electrical panel, etc. to adapt the unit to your specific application and need
- › Thanks to a large operating envelope, the unit is suitable for all possible process and comfort applications
- › High efficient flooded type heat exchanger allowing maximum unit performances
- › One or two truly independent refrigerant circuits for outstanding reliability



› More information about EWWD-VZSS

Cooling only/Heating only				EWWD-VZSS	600	700	760	890	C10	C12	C13	C14	C16	C17	C19	C21	
Space cooling	A Condition (35°C) Pdc			kW	609,91	704,22	756,52	894,23	1.039,49	1.173,02	1.288,02	1.381,01	1.552,02	1.722,02	1.875,55	2.051,2	
	ηs,c			%	340		337,2	331,6	332	337,2	331,6	331,2	320,8	338,8	322	338,8	
SEER					8,7		8,63	8,49	8,5	8,63	8,49	8,48	8,22	8,67	8,25	8,67	
Cooling capacity	Nom.			kW	610	704	757	894	1.039	1.173	1.288	1.381	1.552	1.722	1.876	2.051	
Power input	Cooling	Nom.		kW	110	132	142	162	196	231	252	276	315	339	380	404	
		Method		Variable													
Capacity control	Minimum capacity			%	20				10								
	EER				5,5	5,31	5,3	5,52	5,29	5,07	5,11	5	4,93	5,08	4,93	5,08	
IPLV					9,43	9,36	9,4	9,37	9,4	9,52	9,56	9,57	9,36	9,7	9,38	9,65	
Dimensions	Unit	Height		mm	2.123			2.292	2.487	2.296			2.350		2.338	2.498	
		Width		mm	1.178	1.179		1.233	1.303	1.484		1.487		1.484	1.580	1.627	1.753
		Depth		mm	3.722	3.750		3.690	3.822	4.792			4.508		4.750		
Weight	Unit			kg	2.892	2.928	2.941	3.451	4.237	5.570	5.790	5.820	6.220	6.890	7.260	8.260	
	Operation weight			kg	2.977	3.033	3.053	3.611	4.488	5.980	6.220	6.290	6.690	7.480	7.830	9.070	
Water heat exchanger - evaporator	Type			Flooded shell and tube													
	Water volume			l	88		96	134	156	230		270		320		380	
	Water flow rate	Cooling	Nom.		l/s	29,2	33,8	36,3	42,9	49,9	56,2	61,7	66,1	74,4	82,5	89,9	98,2
Water pressure drop			Cooling	nom.	kPa	79	106	88	98	102	69	84	70	89	78	92	80
Water heat exchanger - condenser	Type			Shell and tube													
	Water volume			l	81	102		126	217	180	200		270		250	430	
	Water flow rate	Cooling	Nom.		l/s	35,3	41	44,1	51,9	60,6	69,1	75,8	81,5	91,9	101	111	120
Water pressure drop			Cooling	nom.	kPa	31	29	33	29	33	44	39	45	66	42	55	37
Compressor	Type			Driven vapour compressor													
	Quantity			1				2									
Sound power level	Cooling	Nom.		dB(A)	101	105		107	106		107		108		110		
Sound pressure level	Cooling	Nom.		dB(A)	82	86		88	87		88		89		90		
Operation range	Evaporator	Cooling	Min.~Max.		°CDB		-3~-20										
			Condenser	Cooling	Min.~Max.		16~63										
Refrigerant	Type/GWP				R-134a/1.430												
	Charge			kg	100	110		170	180	250	260	290		320		350	
	Circuits			1				2									
Piping connections	Evaporator water inlet/outlet (OD)			mm	139,7			168,3	219,1								
	Condenser water inlet/outlet (OD)			mm	168,3		219,1		168,3 / 168,3				219,1 / 219,1				
Unit	Starting current		Max	A	179	214	245	295	344	-							
	Running current	Cooling	Nom.		A	171	202	220	249	300	349	379	414	470	508	566	604
			Max		A	256	306	350	421	491	553	555	612	727	810	926	1.009
Power supply	Phase/Frequency/Voltage			Hz/V	3~/50/400												



# Water cooled screw inverter chiller, high efficiency, standard sound

- › High energy efficiency both at full and part load conditions
- › Compact footprint through stacked heat exchanger lay-out
- › Heat pump version with reversibility on water side (up to 65°C hot water production)
- › Multiple options available: sound proof cabinet, rapid restart, removable electrical panel, etc. to adapt the unit to your specific application and need
- › Thanks to a large operating envelope, the unit is suitable for all possible process and comfort applications
- › High efficient flooded type heat exchanger allowing maximum unit performances
- › One or two truly independent refrigerant circuits for outstanding reliability



› More information about EWWD-VZXS



Cooling only/Heating only				EWWD-VZXS	450	500	610	710	800	900	C11	C12	C13	C14	C16	C17	C19	C21	
Space cooling	A Condition (35°C) Pdc			kW	448,83	500,51	612,77	713,11	793,52	901,21	1.053,02	1.194,03	1.305,01	1.406,98	1.593,03	1.748,03	1.912,01	2.074,02	
	ηs,c			%	324,8	329,2	347,2	350	345,6	337,6	344,4	347,6	342,4	348	347,2	347,6	337,2	344,4	
SEER					8,32	8,43	8,88	8,95	8,84	8,64	8,81	8,89	8,76	8,9	8,88	8,89	8,63	8,81	
Cooling capacity	Nom.			kW	449	501	613	713	794	901	1.053	1.194	1.305	1.407	1.593	1.748	1.912	2.074	
Power input	Cooling	Nom.		kW	81,2	89,7	108	128	146	159	192	221	244	262	296	329	365	394	
		Method																	
Capacity control	Minimum capacity			%	Variable														
					20					10									
EER					5,53	5,58	5,64	5,54	5,43	5,67	5,46	5,38	5,34	5,36	5,38	5,31	5,23	5,25	
IPLV					9,42	9,59	9,52	9,66	9,64	9,48	9,58	9,66	9,67	9,76	9,74	9,82	9,68	9,7	
Dimensions	Unit	Height	mm	2.135	2.123	2.235		2.487		2.296		2.301	2.350	2.500	2.469	2.493			
		Width	mm	1.178	1.179	1.189		1.303		1.484		1.639	1.579	1.580	1.610	1.704	1.769		
		Depth	mm	3.722	3.750	3.690		3.822		4.792		4.508		4.750	4.874				
Weight	Unit			kg	2.968	2.911	3.102	3.470	3.451	4.257	4.552	5.860	6.240	6.520	6.920	7.530	7.790	8.670	
	Operation weight			kg	3.098	3.006	3.274	3.648	3.611	4.518	4.860	6.370	6.760	7.130	7.530	8.300	8.560	9.630	
Water heat exchanger - evaporator	Type			Flooded shell and tube															
	Water volume			l	70	88	136	134		168	199	270		320		380	480		
	Water flow rate	Cooling	Nom.	l/s	21,5	24	29,3	34,1	38	43,2	50,4	57,1	62,5	67,3	76,3	83,6	91,4	99,2	
Water heat exchanger - condenser	Type			Shell and tube															
	Water volume			l	81	92	126	145	126	217	241	240	250		290		390	290	480
	Water flow rate	Cooling	Nom.	l/s	26,4	29,4	35,3	41,2	46,1	52	61	69,8	76,3	82,2	93,2	102	112	121	
Compressor	Type			Driven vapour compressor															
	Quantity			1					2										
Sound power level	Cooling	Nom.		dB(A)	97	99	101	105		107		106		107		108	109	110	
		Nom.		dB(A)	78	80	82	86		88		87		88		89		90	
Operation range	Evaporator	Cooling	Min.~Max.	°CDB	-3~-20														
			Condenser	Min.~Max.	°CDB	16~65													
Refrigerant	Type/GWP			R-134a/1.430															
	Charge			kg	95	100	110	170		180	250	260	290		320		350		
Piping connections	Circuits			1					2										
	Evaporator water inlet/outlet (OD)			mm	139,7		168,3		219,1		219,1		219,1		219,1 / 219,1		273		
Unit	Condenser water inlet/outlet (OD)			mm	168,3		219,1		168,3 / 219,1		219,1		219,1 / 219,1						
	Starting current	Max		A	155	173	179	214	256	295	344	-							
Running current		Cooling	Nom.	A	126	140	171	201	229	249	299	340	372	400	450	498	554	596	
	Max			A	222	247	256	306	366	421	491	553	555	612	727	810	926	1.009	
Power supply	Phase/Frequency/Voltage			Hz/V	3~/50/400														

# Water cooled screw inverter chiller, premium efficiency, standard sound

- › Premium energy efficiency both at full and part load conditions
- › Compact footprint through stacked heat exchanger lay-out
- › Heat pump version with reversibility on water side (up to 65°C hot water production)
- › Multiple options available: sound proof cabinet, rapid restart, removable electrical panel, etc. to adapt the unit to your specific application and need
- › Thanks to a large operating envelope, the unit is suitable for all possible process and comfort applications
- › High efficient flooded type heat exchanger allowing maximum unit performances
- › One or two truly independent refrigerant circuits for outstanding reliability



› More information about EWWD-VZPS

Cooling only/Heating only				EWWD-VZPS	505	715	910	C12	C16	C18	
Space cooling	A Condition (35°C) Pdc			kW	505,02	717,71	908,11	1.201,02	1.604,03	1.757,01	
	ηs,c			%	339,6	355,2	344,4	353,6	354	350	
SEER					8,69	9,08	8,81	9,04	9,05	8,95	
Cooling capacity	Nom.			kW	505	718	908	1.201	1.604	1.757	
Power input	Cooling	Nom.		kW	85,1	124	153	218	291	326	
		Method		Variable							
Capacity control	Minimum capacity			%	20			10			
	EER				5,93	5,77	5,91	5,49	5,5	5,39	
IPLV				9,61	9,68	9,57	9,79	9,82	9,92		
Dimensions	Unit	Height	mm	2.108	2.430	2.487	2.302	2.500	2.493		
		Width	mm	1.179	1.287	1.303	1.579	1.610	1.769		
		Depth	mm	3.750	3.822		4.508	4.750	4.874		
Weight	Unit			kg	3.247	4.082	4.346	6.310	7.530	8.250	
	Operation weight			kg	3.375	4.349	4.660	6.900	8.300	9.200	
Water heat exchanger - evaporator	Type			Flooded shell and tube							
	Water volume			l	96	168	199	320	380	480	
	Water flow rate	Cooling	Nom.	l/s	24,2	34,3	43,4	57,4	76,7	84	
			Water pressure drop	Cooling	Nom.	kPa	55	42	44	38	49
Water heat exchanger - condenser	Type			Shell and tube							
	Water volume			l	126	217	241	270	390	470	
	Water flow rate	Cooling	Nom.	l/s	29,4	41,3	52,1	69,9	93,4	102	
			Water pressure drop	Cooling	Nom.	kPa	16	17	19	21	
Compressor	Type			Driven vapour compressor							
	Quantity				1			2			
Sound power level	Cooling	Nom.		dB(A)	99	105		106	107	109	
		Sound pressure level		Cooling	Nom.	dB(A)	80	86		87	88
Operation range	Evaporator	Cooling	Min.~Max.	°CDB	-3~-20						
			Condenser	Cooling	Min.~Max.	°CDB	16~65				
Refrigerant	Type/GWP			R-134a/1.430							
	Charge			kg	100	150	180	290	320	350	
	Circuits	Quantity			1			2			
Evaporator water inlet/outlet (OD)			mm	139,7	219,1			219,1 / 219,1		273	
Condenser water inlet/outlet (OD)			mm	219,1			219,1 / 219,1				
Unit	Starting current			Max	A	173	214	295	-		
	Running current	Cooling	Nom.	A	138	200	247	338	447	497	
				Max	A	247	306	421	553	727	810
Power supply	Phase/Frequency/Voltage			Hz/V	3~/50/400						





# Water cooled screw inverter chiller, standard efficiency, standard sound

- › Optimized energy efficiency both at full and part load conditions
- › Compact footprint through stacked heat exchanger lay-out
- › Heat pump version with reversibility on water side (up to 65°C hot water production)
- › Multiple options available: sound proof cabinet, rapid restart, removable electrical panel, etc. to adapt the unit to your specific application and need
- › Thanks to a large operating envelope, the unit is suitable for all possible process and comfort applications
- › High efficient flooded type heat exchanger allowing maximum unit performances
- › One or two truly independent refrigerant circuits for outstanding reliability
- › HFO R-1234ze Refrigerant with Ozone Depletion Potential equal to zero and extremely low Global Warming Potential



EWWH-VZSS

MicroTech III



› More information about EWWH-VZSS



Cooling Only				EWWH-VZSS												
				445	515	550	660	770	860	940	C10	C12	C13	C14	C15	
Space cooling	A Condition (35°C) Pdc			kW	443	512	548,51	657,51	767,8	865,2	940,6	1.011,7	1.142,46	1.271,38	1.396,11	1.524,83
	ηs,c			%	336,4	338,4	336,8	348,4	345,2	318,4	327,2	339,6	331,2	340	345,6	353,2
SEER					8,61	8,66	8,62	8,91	8,83	8,16	8,38	8,69	8,48	8,7	8,84	9,03
Cooling capacity	Nom.			kW	443	512	549	658	768	865	941	1.012	1.142	1.271	1.396	1.525
Power input	Cooling	Nom.		kW	82,8	98,1	107	123	149	172	188	205	235	254	282	302
Capacity control	Method			Variable												
	Minimum capacity			%	20					10						
EER					5,35	5,22	5,15	5,34	5,14	5,02	5	4,93	4,87	5,01	4,95	5,04
IPLV					9,25		9,24	9,48	9,32	8,94	9,08	9,13	9,14	9,3	9,13	9,34
Dimensions	Unit	Height		mm	2.123			2.292	2.487	2.296			2.350	2.338	2.498	
		Width		mm	1.178	1.179		1.233	1.303	1.484	1.487		1.484	1.580	1.627	1.753
		Depth		mm	3.722	3.750		3.690	3.822	4.792			4.508		4.750	
Weight	Unit			kg	2.892	2.928	2.941	3.451	4.237	5.570	5.790	5.820	6.220	6.890	7.260	8.260
		Operation weight		kg	2.977	3.033	3.053	3.611	4.488	5.980	6.220	6.290	6.690	7.480	7.830	9.070
Water heat exchanger - evaporator	Type			Flooded shell and tube												
	Water volume			l	88		96	134	156	230		270		320		380
	Water flow rate	Cooling	Nom.	l/s	21,2	24,5	26,2	31,5	36,8	41,4	45	48,4	54,6	60,8	66,8	72,9
	Water pressure drop			kPa	46	61	52	59	64	39	46	39	50	44	53	45
Water heat exchanger - condenser	Type			Shell and tube												
	Water volume			l	81	102		126	217	180		200		270	250	430
	Water flow rate	Cooling	Nom.	l/s	25,5	29,6	31,8	38,1	44,8	50,3	54,8	59	66,8	74	81,4	88,7
	Water pressure drop			kPa	19	17	20	19	17	25	22	25	38	25	32	18
Compressor	Type			Driven vapour compression												
	Quantity			1					2							
Sound power level	Cooling	Nom.		dB(A)	101	105		107	106		107		108		110	
Sound pressure level	Cooling	Nom.		dB(A)	82	86		88	87		88		89		90	
Refrigerant	Type/GWP			R-1234(ze)/7												
	Charge			kg	100	110		170	180	250	260	290		320		350
	Circuits			Quantity	1					2						
Refrigerant circuit	Charge			kg	100	110		170	180	250	260	290		320		350
Piping connections	Evaporator water inlet/outlet (OD)			mm	139,7			168,3	219,1			219,1				
	Condenser water inlet/outlet (OD)			mm	168,3			219,1			168,3 / 168,3		219,1 / 219,1			
Unit	Running current	Cooling	Nom.	A	131,0	153,0	167,0	188,0	227,0	264,0	287,0	312,0	353,0	385,0	426,0	458,0
		Max		A	213,0	246,0	265,0	277,0	404,0	445,0	458,0	491,0	523,0	649,0	744,0	807,0
Power supply	Phase/Frequency/Voltage			Hz/V	3~/50/400											

# Water cooled screw inverter chiller, high efficiency, standard sound

- › High energy efficiency both at full and part load conditions
- › Compact footprint through stacked heat exchanger lay-out
- › Heat pump version with reversibility on water side (up to 65°C hot water production)
- › Multiple options available: sound proof cabinet, rapid restart, removable electrical panel, etc. to adapt the unit to your specific application and need
- › Thanks to a large operating envelope, the unit is suitable for all possible process and comfort applications
- › High efficient flooded type heat exchanger allowing maximum unit performances
- › One or two truly independent refrigerant circuits for outstanding reliability
- › HFO R-1234ze Refrigerant with Ozone Depletion Potential equal to zero and extremely low Global Warming Potential



EWWH-VZXS

MicroTech III



› More information about EWWH-VZXS



Cooling Only				EWWH-VZXS															
				335	365	450	525	580	670	800	875	950	C11	C12	C13	C14	C15		
Space cooling	A Condition (35°C) Pdc			kW		329,01	364,52	448	520,61	579,19	665,41	788,2	877,36	952,01	1.028,81	1.169,3	1.288,48	1.421,75	1.540,03
	ηs,c			%		296	307,2	343,6	347,2	343,2	356	354,4	326	334	346,8		358		356,8
SEER						7,6	7,88	8,79	8,88	8,78	9,1	9,06	8,35	8,55	8,87		9,15		9,12
Cooling capacity	Nom.			kW		329	365	448	521	579	665	788	877	952	1.029	1.169	1.288	1.422	1.540
Power input	Cooling	Nom.		kW		60,5	66,6	81	96	109	121	147	168	185	198	224	248	276	298
Capacity control	Method			Variable															
	Minimum capacity			%		20						10							
EER						5,44	5,48	5,53	5,42	5,29	5,49	5,37	5,23	5,16	5,19	5,22	5,19	5,16	
IPLV						8,51	8,79	9,46	9,51	9,47	9,63	9,65	9,19	9,27	9,46	9,37	9,52	9,23	9,5
Dimensions	Unit	Height	mm	2.135		2.123		2.235		2.487		2.296		2.301	2.350	2.500	2.469	2.493	
		Width	mm	1.178		1.179		1.189		1.303		1.484	1.639	1.579	1.580	1.610	1.704	1.769	
		Depth	mm	3.722		3.750		3.690		3.822		4.792	4.508		4.750		4.874		
Weight	Unit	kg		2.968	2.911	3.102	3.470	3.451	4.257	4.552	5.860	6.240	6.520	6.920	7.530	7.790	8.670		
		Operation weight		kg	3.098	3.006	3.274	3.648	3.611	4.518	4.860	6.370	6.760	7.130	7.530	8.300	8.560	9.630	
Water heat exchanger - evaporator	Type			Flooded shell and tube															
	Water volume			l	70	88	136	134		168	199	270		320		380		480	
	Water flow rate	Cooling	Nom.	l/s	15,8	17,5	21,4	24,9	27,7	31,8	37,7	41,9	45,5	49,1	55,9	61,6	67,9	73,6	
Water heat exchanger - condenser	Water volume			l	81	92	126	145	126	217	241	240	250	290		390		480	
	Water flow rate	Cooling	Nom.	l/s	18,9	20,9	25,7	30	33,5	38,4	45,7	50,7	55,1	59,6	67,6	74,6	82,3	89,3	
	Water pressure drop	Cooling	Nom.	kPa	54	38	35	37	31	39	36	29	34	28	37	32	28	33	
Compressor	Type			Driven vapour compression															
	Quantity			1						2									
	Sound power level	Cooling	Nom.	dB(A)	97	99	101	105		107		106		107		108		109	110
Sound pressure level	Cooling	Nom.	dB(A)	78	80	82	86		88		87		88		89		90		
Refrigerant	Type/GWP			R-1234ze/7															
	Charge			kg	95		100	110	170		180	250	260	290		320		350	
	Circuits	Quantity		1						2									
Piping connections	Evaporator water inlet/outlet (OD)			mm	139,7		168,3		219,1						273				
	Condenser water inlet/outlet (OD)			mm	168,3		219,1		168,3 / 219,1		219,1 / 219,1								
Unit	Running current	Cooling	Nom.	A	96,0	106,0	129,0	151,0	173,0	187,0	226,0	259,0	284,0	304,0	341,0	379,0	421,0	454,0	
		Max	A	178,0	199,0	213,0	246,0	275,0	277,0	404,0	445,0	458,0	491,0	523,0	649,0	744,0	807,0		
Power supply	Phase/Frequency/Voltage			Hz/V	3~/50/400														

# Water cooled screw inverter chiller, premium efficiency, standard sound

- › Premium energy efficiency both at full and part load conditions
- › Compact footprint through stacked heat exchanger lay-out
- › Heat pump version with reversibility on water side (up to 65°C hot water production)
- › Multiple options available: sound proof cabinet, rapid restart, removable electrical panel, etc. to adapt the unit to your specific application and need
- › Thanks to a large operating envelope, the unit is suitable for all possible process and comfort applications
- › High efficient flooded type heat exchanger allowing maximum unit performances
- › One or two truly independent refrigerant circuits for outstanding reliability
- › HFO R-1234ze Refrigerant with Ozone Depletion Potential equal to zero and extremely low Global Warming Potential



EWWH-VZPS

MicroTech III



› More information about EWWH-VZPS

Cooling Only				EWWH-VZPS	370	530	680	880	C12	C13	
Space cooling	A Condition (35°C) Pdc			kW	369,3	525,1	677,11	883,79	1.180,43	1.295,36	
	ηs,c			%	316,8	352,8	363,6	334,4	352,4	348,8	
SEER					8,12	9,02	9,29	8,56	9,01	8,92	
Cooling capacity	Nom.			kW	369	525	677	884	1.180	1.295	
Power input	Cooling	Nom.		kW	64,7	94,9	119	166	221	247	
Capacity control	Method			Variable							
	Minimum capacity			%	20				10		
EER					5,71	5,53	5,67	5,34	5,35	5,25	
IPLV					9,13	9,68	9,96	9,37	9,56	9,61	
Dimensions	Unit	Height		mm	2.108	2.430	2.487	2.302	2.500	2.493	
		Width		mm	1.179	1.287	1.303	1.579	1.610	1.769	
		Depth		mm	3.750	3.822		4.508	4.750	4.874	
Weight	Unit			kg	3.247	4.082	4.346	6.310	7.530	8.250	
		Operation weight		kg	3.375	4.349	4.660	6.900	8.300	9.200	
Water heat exchanger - evaporator	Type			Flooded shell and tube							
	Water volume			l	96	168	199	320	380	480	
	Water flow rate	Cooling	Nom.	l/s	17,7	25,1	32,3	42,2	56,4	61,9	
Water heat exchanger - condenser	Type			Shell and tube							
	Water volume			l	126	217	241	270	390	470	
	Water flow rate	Cooling	Nom.	l/s	21,1	30,1	38,9	50,9	68	74,9	
Compressor	Type			Driven vapour compression							
	Quantity			1				2			
	Sound power level	Cooling	Nom.	dB(A)	99	105		106	107	109	
Sound pressure level	Cooling	Nom.	dB(A)	80	86		87	88	89		
Refrigerant	Type/GWP			R-1234(ze)/7							
	Charge			kg	100	150	180	290	320	350	
	Circuits	Quantity			1			2			
Refrigerant circuit	Charge			kg	100	150	180	290	320	350	
Piping connections	Evaporator water inlet/outlet (OD)			mm	139,7	219,1				273	
	Condenser water inlet/outlet (OD)			mm	219,1				219,1 / 219,1		
Unit	Running current	Cooling	Nom.	A	104,0	150,0	185,0	257,0	338,0	378,0	
		Max		A	199,0	246,0	277,0	445,0	523,0	649,0	
Power supply	Phase/Frequency/Voltage			Hz/V	3~/50/400						



**DZ**  
CHILLER SERIES

AVAILABLE ON

R-1234ze(E) platform

**R-1234ze(E)**

R-134a platform

**R-134a**

Single compressor

From 320 kW up to 742 kW on R-134a platform

From 227 kW up to 478 kW on R-1234ze(E) platform

Dual compressor

From 610 kW up to 1478 kW on R-134a platform

From 429 kW up to 945 on R-1234ze(E) platform

Triple compressor

From 1038 kW up to 2173 kW on R-134a platform

From 741 kW up to 1417 kW on R-1234ze(E) platform





# Features

- › Magnetic Bearing Oil Free Centrifugal compressors
- › High efficiency flooded Heat Exchangers
- › Application flexibility, suitable for both Dry Cooler and Cooling Tower applications
- › App Ready for easy interface with remote smart device
- › Compact design through stacked heat exchangers
- › Heat pump version includes hot gas bypass
- › Sound Proof Cabinet option
- › Economizer availability on specific sizes
- › Rapid Restart option
- › Up to 3 compressors always in single circuit

available on





# Why choose DZ chiller series?

The DZ chiller series incorporates a number of advanced technology features that are unique in the market.

## Magnetic Bearing Technology

Fitted with centrifugal compressors utilizing frictionless magnetic bearings for oil-free operation, integrated variable-frequency drives, and high-speed direct drive technology

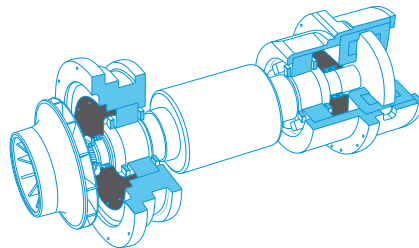

## Industry leading part load efficiency

The high efficiency compressor is matched with highly efficient heat exchangers to make an impressive chiller

## Increased reliability

The frictionless magnetic bearing design needs no oil management system, resulting in increased reliability and reduced maintenance

## Green building design

Developed to achieve maximum efficiency and is future-proofed to comply with existing design and regulatory standards as well as longer-term EU energy goals

## Application flexibility

The DZ Series includes models suitable for both high condensing operation (Dry Cooler application) and low condensing operation (Cooling Tower applications)



### Designed for compactness

Footprint reduced to the minimum levels thanks to a unique design with stacked heat exchangers.

### Option flexibility



Wide range of options, such as the **Rapid Re-Start**, allowing the unit to restart after a power failure within 26 seconds following power restoration, an automatic transfer switch to backup generator. Comprehensive solution for data centers applications.



**Low noise solution** with dedicated Compressor sound proof cabinet to ensure outstanding flexibility to match any specific application.



#### Hot Gas Bypass (HGBP).

The hot gas bypass (HGBP) reduces compressor cycling in order to stabilize the chilled water temperature at very low loads. The HGBP is a control capacity device that feeds the discharge gas directly into the evaporator in order to extend the minimum power range limit. This hot gas provides a stable refrigerant flow and keeps the chiller from short cycling under reduced load conditions combined with high lift.

It also reduces surge potential on heat pump mode units.



#### Heat Pump Version.

The Heat Pump Version including Pursuit Mode and allow reversibility on the water side. Cooling or heating mode operation can be selected by means of a dedicated switch installed on the unit electrical panel. If communication card is selected, cooling or heating mode operation can be managed by BMS. It includes HGBP always and additional 20 mm insulation.

### Connectivity

Enabled for operation via the Daikin on Site platform. The DZ can be monitored remotely, allowing the system to be accessed with one click, for system optimization and preventative maintenance.

Enabled for operation with an App specifically designed to operate on the unit by remote smart device (tablet, smartphone, PC). App is characterized by and easy-to-access data, and it allows an effective graphical representation of the main data and displaying the unit operating parameters.



# Water cooled centrifugal chiller, high efficiency, standard sound

- › No friction loss, no oil contamination, no additional oil management systems and an increased equipment life thanks to the magnetic bearing technology
- › Excellent part load efficiency
- › Totally oil-free operation resulting in reduced maintenance costs and increased reliability
- › Compact footprint through stacked heat exchanger lay-out
- › Increased installation flexibility thanks to limited dimensions
- › Easy handling: thanks to its compact size, it can easily pass through the doorway
- › MicroTech III controller with superior control logic and easy interface
- › A wide portfolio of options is available to meet different requirements.
- › The compressor vibration levels are extremely low as a result of the high-speed design
- › Optimized for highly efficient R-134a refrigerant and compatible with next generation refrigerants



› More information about EWWD-DZXS

Cooling Only		EWWD-DZXS		320	440	530	610	640	700	880	C10	C13	C14	C15	C21						
Space cooling	A Condition Pdc		kW	320,01	443,01	528	610,02	638,01	699,97	883,01	1.056	1.325,26	1.402	1.564,57	2.070,42						
	ηs,c		%	334	314	324	344	349	342	350	363	349,8	362	360,6	365,4						
SEER				8,56	8,05	8,29	8,81	8,92	8,75	8,95	9,27	8,82	9,26	9,09	9,21						
Cooling capacity	Nom.		kW	320	443	528	610	638	700	883	1.056	1.325	1.402	1.565	2.070						
Power input	Cooling	Nom.	kW	66,5	88,5	102	124,7	131	126	176	205	272	256	310	391						
				Capacity control																	
Method		Variable																			
Minimum capacity		%		30	21		16	15	18	11		7	9	8	6						
EER				4,81	5	5,14	4,89	4,85	5,53	5,01	5,15	4,88	5,46	5,04	5,3						
IPLV				9,68	9,67	10	9,66	9,78	10,1	9,86	10,2	9,56	10,5	9,91	9,93						
Dimensions	Unit	Height	mm	1.865				1.985				2.200		2.083		2.200		2.225		2.290	
		Width	mm	1.055				1.160				1.270		1.510		1.270		1.510			
		Depth	mm	3.625				3.585				3.580		4.793		3.580		4.768		4.812	
Weight	Unit		kg	1.700	1.900	2.000	2.850		2.600	2.900	3.600	4.350	3.800	4.750	5.500						
	Operation weight		kg	1.973	2.216	2.347	3.197	3.344	3.102	3.458	4.292	5.020	4.579	5.540	6.570						
Water heat exchanger - evaporator	Type		Flooded shell and tube																		
	Water volume		l	70	96	107		134		156	199	271,8	229	317,4	444,3						
	Water flow rate Nom.		l/s	15,3	21,2	25,3	29,1	30,5	33,5	42,3	50,6	63,4	67,2	74,9	99,1						
	Water pressure drop		Cooling	Nom.	kPa	47,4	40,6	45	59,1	51	61,3	64	60,4	60,1	74	61,1	71,9				
Water heat exchanger - condenser	Type		Shell and tube																		
	Water volume		l	83	100	120		170	188	211	263	359,9	320	442,6	603,6						
	Water flow rate Nom.		l/s	18,3	25,3	30,1	35,1	36,7	39,4	50,5	60,1	76,1	79,1	89,5	117						
	Water pressure drop		Cooling	Nom.	kPa	49,2	59,5	54,5	74	46,2	41,6	50,9	50,3	56	52,9	43	57				
Compressor	Type		Driven vapour compressor																		
	Quantity			1			2			1		2		3		2		3			
Sound power level	Cooling	Nom.	dB(A)	87,9	88,9	89,9	91,1	91	91,1	92	93,3	99	94,3	100	101						
Sound pressure level	Cooling	Nom.	dB(A)	69,6	70,6	71,6	72,6				73,6	74,6	80	75,6	81	82					
Operation range	Evaporator	Cooling	Min.-Max.	°CDB	4~20																
					Condenser	Cooling	Min.-Max.	°CDB	20~55	20~42	20~55	20~42	20~55	20~42	20~55	20~42					
Refrigerant	Type/GWP		R-134a/1.430																		
	Charge		kg	120				180				230	320	230	340	390					
	Circuits		Quantity	1																	
Refrigerant charge			TCO,Eq	172				257				329	458	329	486	558					
Piping connections	Evaporator water inlet/outlet (OD)		mm	139,7				168,3				219,1									
	Condenser water inlet/outlet (OD)		mm	139,7				168,3				219,1									
Unit	Running current	Cooling	Nom.	A	100,55	138,22	155,23	203,41	200,56	190,23	274,86	309,17	445	383,87	471,7	588					
					Max	A	134	208	166	267	196	417	331	631	392	511	589				
Power supply	Phase/Frequency/Voltage		Hz/V	3~/50/400																	

# Water cooled centrifugal chiller, high efficiency, standard sound. With economizer



› More information about EWWD-DZXE



Cooling Only				EWWD-DZXE														
				340	470	570	670	680	740	950	C10	C11	C14	C15	C17	C22		
Space cooling	A Condition Pdc			kW	341,01	474,02	566	670	682	741,96	946	1.038,18	1.130	1.436,52	1.477,93	1.684,76	2.172,91	
	η <sub>s,c</sub>			%	335	316	326	345	349	346	352	339,8	365	350,6	366	359	370,2	
SEER					8,57	8,09	8,34	8,82	8,93	8,86	9	8,57	9,32	8,84	9,35	9,05	9,33	
Cooling capacity	Nom.			kW	341	474	566	670	682	742	946	1.038	1.130	1.437	1.478	1.685	2.173	
Power input	Cooling	Nom.		kW	69,9	93,5	108	138,4	138	131	186	210	216	288	263	329	393	
Capacity control	Method			Variable														
	Minimum capacity			%	29	20	15	17	10	7	9	7	6					
EER					4,88	5,07	5,22	4,84	4,91	5,65	5,08	4,94	5,23	4,98	5,6	5,12	5,53	
IPLV					9,57	9,62	10	9,61	9,63	10,2	9,79	9,58	10,1	9,55	10,4	9,86	10,00	
Dimensions	Unit	Height	mm	1.865				1.985				2.082	2.200	2.083	2.200	2.225	2.290	
		Width	mm	1.055				1.160				1.510	1.270	1.510	1.270	1.510		
		Depth	mm	3.625				3.585				4.688	3.580	4.793	3.580	4.768	4.812	
Weight	Unit			kg	1.750	1.950	2.050	2.850	2.650	3.000	4.400	3.700	4.700	3.900	5.100	5.900		
	Operation weight			kg	2.033	2.276	2.407	3.197	3.354	3.162	3.568	4.970	4.412	5.370	4.699	5.890	6.920	
Water heat exchanger - evaporator	Type			Flooded shell and tube														
	Water volume			l	70	96	107	134	156	207,3	199	317,4	229	317,4	444,3			
	Water flow rate Nom.			l/s	16,4	22,7	27,1	32	32,7	35,6	45,3	49,1	54,1	68	70,9	80,4	103	
Water heat exchanger - condenser	Type			Shell and tube														
	Water volume			l	83	100	120	170	188	211	326,4	263	359,9	320	442,6	603,6		
	Water flow rate Nom.			l/s	19,6	27	32,1	38,6	39,1	41,6	53,9	58,9	64,1	81,4	83	95,8	121	
Compressor	Type			Driven vapour compressor														
	Quantity				1	2	1	2	3	2	3	2	3					
	Cooling	Nom.		dB(A)	87,9	88,9	89,9	91,1	91	91,1	92	98	93,3	99	94,3	100	101	
Sound pressure level	Cooling	Nom.		dB(A)	69,6	70,6	71,6	72,6	73,6	79	74,6	80	75,6	81	82			
Operation range	Evaporator	Cooling	Min.~Max.	°CDB	4~20													
	Condenser	Cooling	Min.~Max.	°CDB	20~55	20~42	20~55	20~42	20~55	20~42	20~55	20~42	20~55	20~42				
Refrigerant	Type/GWP			R-134a/1.430														
	Charge			kg	130	120	200	190	200	350	250	400	250	420	470			
	Circuits	Quantity			1													
Refrigerant charge	TCO <sub>Eq</sub>				186	172	286	272	286	501	358	572	358	672				
Piping connections	Evaporator water inlet/outlet (OD)			mm	139,7				168,3				219,1					
	Condenser water inlet/outlet (OD)			mm	139,7				168,3				219,1					
Unit	Running	Cooling	Nom.	A	105,42	144,7	162,48	212,9	210,15	196	287,44	318,3	323,53	425,9	392	496	588	
	current	Max		A	134	208	166	267	196	417	406	331	631	392	511	589		
	Power supply			Phase/Frequency/Voltage	Hz/V	3~/50/400												

# Water cooled centrifugal chiller, high efficiency, standard sound

- › No friction loss, no oil contamination, no additional oil management systems and an increased equipment life thanks to the magnetic bearing technology
- › Excellent part load efficiency
- › Totally oil-free operation resulting in reduced maintenance costs and increased reliability
- › Compact footprint through stacked heat exchanger lay-out
- › HFO R-1234ze Refrigerant with Ozone Depletion Potential equal to zero and extremely low Global Warming Potential
- › Increased installation flexibility thanks to limited dimensions
- › Easy handling: thanks to its compact size, it can easily pass through the doorway
- › MicroTech III controller with superior control logic and easy interface
- › A wide portfolio of options is available to meet different requirements.
- › The compressor vibration levels are extremely low as a result of the high-speed design



› More information about EWWH-DZXS

Cooling Only		EWWH-DZXS		230	320	380	430	455	460	640	755	920	950	C11	C13		
Space cooling	A Condition	kW		227,08	318,33	376,33	455,13	454,66	474,48	637,15	752,27	917,79	945,8	1.126	1.352		
	η <sub>s,c</sub>	%		330	346		342		339	352	354	353	360,2	359,4	364,2		
SEER			8,46		8,84		8,74		8,58	8,99	9,04	9,03	9,08	9,06	9,18		
Cooling capacity	Nom.		kW		227	318	376	455		461	637	752	918	945,8	1.126	1.352	
Power input	Cooling	Nom.	kW		45,6	60,5	71,4	93,3	90,6	79,3	120,5	142,1	158,8	181	216,5	237,7	
Capacity control	Method		Variable														
	Minimum capacity		%		24	21	20	13	12	20	11	10		11		16	
EER			4,98		5,27		4,88	5,02	5,81	5,29		5,78	5,22	5,2	5,69		
IPLV			9,61		9,79	9,83	9,71	9,68	9,73	9,99	10,05	9,99	9,83	9,91	9,98		
Dimensions	Unit	Height	mm		1.865			1.985			2.200		2.083	2.225	2.290		
		Width	mm		1.055			1.160			1.270		1.510				
		Depth	mm		3.625			3.585			3.580		4.793	4.768	4.812		
Weight	Unit	kg		1.700	1.900	2.000	2.850		2.600	2.900	3.600	3.800	4.350	4.750	5.500		
	Operation weight		kg		1.973	2.216	2.347	3.197	3.344	3.102	3.458	4.292	4.579	5.020	5.540	6.570	
Water heat exchanger - evaporator	Type		Flooded shell and tube														
	Water volume		l		70	96	107		134	156	199	229	271,8	317,4	444,3		
	Water flow rate	Cooling	Nom.	l/s		10,8	15,2	18	20,5	21,7	22	30,4	35,9	43,9	45,2	53,8	64,6
	Water pressure drop	Cooling	Nom.	kPa		28,2	24,6	26,8	31,7	27,8	28,6	35,9	33	34,3	30	31	
Water heat exchanger - condenser	Type		Shell and tube														
	Water volume		l		83	100	120		170	188	211	263	320	359,9	442,6	603,6	
	Water flow rate	Cooling	Nom.	l/s		13	18,1	21,4	24,5	26,1	25,8	36,2	42,7	51,4	53,8	64,2	76
	Water pressure drop	Cooling	Nom.	kPa		24	30	27	35	23	17	25		22	27	26	24
Compressor	Type		Driven vapour compressor														
	Quantity				1			2		1		2		3			
Sound power level	Cooling	Nom.	dBA		87,9	88,9	89,9	91,1	91	91,1	92	93,3	94,3	99	100	101	
Sound pressure level	Cooling	Nom.	dBA		69,6	70,6	71,6	72,6		73,6		74,6	75,6	80	81	82	
Operation range	Evaporator	Cooling	Min.-Max.	°CDB		4~20											
	Condenser	Cooling	Min.-Max.	°CDB		20~55	20~42	20~55	20~42	20~55	20~42	20~55	20~42	20~55	20~42		
Refrigerant	Type/GWP		R-1234(ze)/7														
	Charge		kg		120				180				230	320	340	390	
	Circuits	Quantity	1														
Refrigerant charge			TCO <sub>2</sub> Eq		1				2				458	486	558		
Piping connections	Evaporator water inlet/outlet (OD)		mm		139,7				168,3				219,1				
	Condenser water inlet/outlet (OD)		mm		139,7				168,3				219,1	168,3	219,1		
Unit	Running	Cooling	Nom.	A		72	99	112	133	144	125	198	222	249	297,8	339,2	374,1
	current	Max	A		95	150	123	190		142	300	246	284	451	370	448	
Power supply	Phase/Frequency/Voltage		Hz/V		3~/50/400												

# Water cooled centrifugal chiller, high efficiency, standard sound. With economizer.



> More information about EWWH-DZXE

Cooling Only		EWWH-DZXE	245	345	405	470	480	490	685	740	810	955	C10	C12	C14									
Space cooling	A Condition	kW	241,98	339,33	401,93	460,88	483,83	486,57	678,69	741	802,77	944,73	1.033	1.226	2.172,91									
	ηs,c	%	331	350		335	345	344	356	344,6	358	356		364,2	371,8									
SEER			8,48	8,95	8,94	8,81	8,67	8,83	9,11	8,69	9,16	9,1		9,18	9,37									
Cooling capacity	Nom.	kW	242	339	402	487	474	484	679	741	803	945	1.033	1.226	1.417									
Power input	Cooling	Nom.	kW	47,9	63,4	75,1	98,7	79,5	95,1	126,3	144,6	149,4	159,2	192,9	229,5	238,3								
Capacity control	Method		Variable									Stepless		Variable		Stepless								
	Minimum capacity	%	24	20	19	12	20	12	10	12	9	10		11		17								
EER			5,05		5,35	4,93	5,97	5,09	5,37	5,13	5,37	5,93	5,35	5,34	5,94									
IPLV			9,64	9,88	9,94	9,62	9,87	9,74	10,07	9,66	10,14	10,13	9,92	9,98	9,94									
Dimensions	Unit	Height	mm				1.865				1.985				2.082		2.200		2.083		2.225		2.290	
		Width	mm				1.055				1.160				1.510		1.270				1.510			
		Depth	mm				3.625				3.585				4.688		3.580		4.793		4.768		4.812	
Weight	Unit	kg	1.750	1.950	2.050	2.850	2.650	2.850	3.000	4.400	3.700	3.900	4.700	5.100	5.900									
	Operation weight	kg	2.033	2.276	2.407	3.197	3.162	3.354	3.568	4.970	4.412	4.699	5.370	5.890	6.920									
Water heat exchanger - evaporator	Type		Flooded shell and tube																					
	Water volume	l	70	96	107		134	156	207,3	199	229		317,4	444,3										
	Water flow rate	Cooling	Nom.	l/s	11,6	16,2	19,2	22,4	22,6	23,1	32,4	34,9	38,4	45,2	48,7	57,9	67							
	Water pressure drop	Cooling	Nom.	kPa	29,7	28,4		37,8	30,8	32	41,3	31	38,1	36,9	37	38	33							
Water heat exchanger - condenser	Type		Shell and tube									Flooded Shell & Tube		Shell and tube				Flooded Shell & Tube						
	Water volume	l	83	100	120	188	170	211	326,4	263	320	359,9	442,6	603,6										
	Water flow rate	Cooling	Nom.	l/s	13,9	19,2	22,8	26,7	26,4	27,7	38,5	41,8	45,5	52,8	57,8	68,8	78,4							
	Water pressure drop	Cooling	Nom.	kPa	28	34	31	42	18	26	29	21	28	23	33	30	26							
Compressor	Type		Driven vapour compressor																					
	Quantity		1			2		1		2			3		2		3							
Sound power level	Cooling	Nom.	dB(A)	87,9	88,9	89,9	91,1		91	92	98	93,3	94,3	99	100	101								
Sound pressure level	Cooling	Nom.	dB(A)	69,6	70,6	71,6	72,6		73,6	79	74,6	75,6	80	81	82									
Operation range	Evaporator	Cooling	Min.~Max.	°CDB																				
	Condenser	Cooling	Min.~Max.	°CDB																				
Refrigerant	Type/GWP		R-1234(ze)/7																					
	Charge	kg	130	120	190	200	350	250	400	420	470													
	Circuits	Quantity	1																					
Refrigerant charge		TCO,Eq	1			501	2	572	601	672														
Piping connections	Evaporator water inlet/outlet (OD)	mm	139,7				168,3				219,1													
	Condenser water inlet/outlet (OD)	mm	139,7				168,3				219,1													
Unit	Running	Cooling	Nom.	A	75	103	117	142	125	150	205	277	232	249	311	249								
	current	Max	A	95	150	123	190	142	190	300	286	246	284	451	370	448								
Power supply	Phase/Frequency/Voltage	Hz/V	3~/50/400																					

# Water cooled centrifugal chiller, high efficiency, standard sound

- › Optional Variable Frequency Drive (VFD) to improve the part load efficiency
- › High efficiency flooded type shell and tube evaporator/condensers
- › Lower equipment, installation and annual operating costs than two single compressor chillers (DWDC)
- › Main components can be removed or repaired without shutting down the unit as the chiller has two of everything (compressors, lubrication systems, control systems and starters) (DWDC)
- › Unloading to 5% (DWSC) or 10% (DWDC) of full load provides improved stability of the chilled water temperature and less harmful cycling of compressors
- › Single stage centrifugal compressor (DWSC)



DWSC-DWDC

MicroTech II

› More information about DWDC



› More information about DWSC



Cooling only		DWDC/DWSC	DWDC	DWSC
Cooling capacity	Min.	kW	600	300
	Max.	kW	9.000	4.500
Compressor	Type	Single stage centrifugal compressor		
Refrigerant	Type / GWP	R-134a / 1.430		
	Charge	kg	700 - 1.400	300 - 1.000
		TCO <sub>2</sub> Eq	1.001 - 2.002	429 - 1.430

\* not Eurovent certified





## Options - Water cooled chillers

Description	Code	EWHQ-G	EWQ-G	EWQ-L	EWWD-J	EWWD-VZ	EWWH-VZ	EWWD-DZ	EWWH-DZ
Partial heat recovery	03	Option	Option	Option					
Direct on line starter (DOL)	04	STD	STD	STD					
WyeDelta compressor starter (YD)	05				STD				
Soft starter	06 (5)	Option	Option	Option	Option				
Heat pump version (including pursuit mode)	07a (10)		Option	Option	Option	Option	Option	Option	Option
Brine version	08 (8)	Option	Option	Option	Option	Option	Option		
Double setpoint	10	STD	STD	STD	STD	STD	STD		
Compressor thermal overload relays	11				Option	STD	STD		
Phase monitor	13				STD	STD	STD		
Inverter compressor starter	14					STD	STD	STD	STD
Under / Over voltage control	15				Option	STD	STD		
Control expansion pack ( including under/ ver voltage control, setpoint reset, demand limit, alarm from external device, expansion card POL965)	15a	Option	Option	Option					
Energy meter	16				Option			Option	Option
Energy meter (including current limit)	16a					Option	Option		
Capacitors for power factor correction	17	Option	Option	Option	Option				
Current limit	19				Option			STD	STD
Evaporator victaulic kit	20				STD	STD	STD	STD	STD
Evaporator marine waterbox victaulic (2 passes)	22							Option	Option
Condenser double flanges kit	26				Option	Option	Option	Option	Option
Evaporator water side design pressure (10 Bar)	27					STD	STD	STD	STD
20mm evaporator insulation	29	STD	STD	STD	STD	STD	STD	STD	STD
20mm condenser insulation	33	STD	Option	Option	Option	Option	Option	Option	Option
Condenser victaulic kit	36				STD	STD	STD	STD	STD
Condenser marine waterbox victaulic (2 passes)	38							Option	Option
Condenser water side design pressure (16 Bar)	47				STD				
Condenser water side design pressure (10 Bar)	47a					STD	STD	STD	STD
Alucoat fins coil	49								
CuNi 9010 condenser tubes	50 (9)				Option	Option	Option	Option	Option
Condenser 1 pass (ΔT 48 °C)	51					STD	STD	NC/SO	NC/SO
Condenser 2 passes (ΔT 48 °C)	52				STD			STD	STD
Condenser 3 passes	53b							Option	Option
Evaporator flow switch	58	Option	Option	Option	STD	Option	Option	Option	Option
Condenser flow switch	59	Option	Option	Option		Option	Option	Option	Option
Electronic expansion valve	60	STD	STD	STD	STD	STD	STD	STD	STD
Discharge line shutoff valve	61				STD	Option	Option	Option	Option
Suction line shutoff valve	62				STD	Option	Option	Option	Option
High pressure side manometers	63				Option	Option	Option	Option	Option
Low pressure side manometers	64				Option	Option	Option	Option	Option
Hour run meter	68	Option	STD	STD	STD	STD	STD	STD	STD
General fault contactor	69	Option	STD	STD	STD	STD	STD	STD	STD
Container Kit	71	Option	Option	Option	Option	Option	Option	Option	Option
Rubber anti vibration mounts	75	Option	Option	Option	Option				
Sound proof system (compressor)	76-b (3)	Option	Option	Option	Option	Option	Option	Option	Option
Sound proof system (compressor jacket)	76-c	Option	Option	Option					

CF = Contact the Factory - NA = Not available - STD = Standard - SO = Specify at Order entry  
Please check with the price list the option availability for each size and efficiency/sound version

- (1) For stacked installation the opt. has to be selected for both unit
- (2) Evaporator and condenser victaulic kit is complete with counter victaulic
- (3) Sound proof system - compressor enclosure
- (4) For EWHQ-G-SS range option 132 is available only for sizes 340 kW and 400 kW
- (5) The order of soft starter will have an impact on the delivery time; please contact the Factory
- (6) For EWWQ-G-SS range option 132 is available only for sizes 300 kW and 360 kW
- (7) For EWWQ-L-SS range option 132 is available only for sizes 540 kW to 720 kW
- (8) Option 08 includes option 29 and opt 146
- (9) Unit performance will be affected; contact factory for information. It is mandatory to order the option 26 when selecting CU-Ni 90-10 condenser tubes
- (10) opt 07a includes opt 33
- (11) opt 174 includes opt 146
- (12) opt 111 includes opt 07a and opt 33

## Options - Water cooled chillers

Description	Code	EWHQ-G	EWQ-G	EWQ-L	EWWD-J	EWWD-VZ	EWVH-VZ	EWWD-DZ	EWVH-DZ
Setpoint reset, Demand limit and Alarm from external device	90				STD	STD	STD	STD	STD
Double pressure relief valve with diverter	91	Option	Option	Option	Option	STD	STD	STD	STD
Compressors circuit breakers	95	Option	Option	Option	Option	Option	Option	Option	Option
Fans circuit breakers	96								
Main switch interlock door	97	STD	STD	STD	STD	STD	STD	STD	STD
Emergency stop	98				STD				
Ground fault relay	102	Option	Option	Option	Option	Option	Option	Option	Option
Evaporator 1 pass	103					Option	Option	NC/SO	NC/SO
Evaporator 2 passes	103a					STD	STD	STD	STD
Evaporator 3 passes	103b					Option	Option	Option	Option
Evaporator double flange kit	104					Option	Option	Option	OPTION
Liquid receiver	105								
Rapid restart	110					Option	Option	Option	Option
High temperature kit	111 (12)					Option	Option		
Transport kit	112	Option	Option	Option	Option	Option	Option	Option	Option
Water filter	115	Option	Option	Option					
Refrigerant leak detection	121					Option	Option	Option	Option
Evaporator single pump (low lift)	122	Option	Option						
Evaporator single pump (high lift)	123	Option	Option						
Condenser single pump (low lift)	124	Option	Option						
Condenser single pump (high lift)	125	Option	Option						
Discharge and suction line shut-off valve	126	Option	Option	Option					
High and low pressure side manometers	127	Option	Option	Option					
Master/slave	128	STD	STD	STD		STD	STD	STD	STD
Liquid line shut -off valve	129	Option							
Evaporator and condenser victaulic kit	130 (2)	STD	STD	STD					
Part winidng start	132	STD (4)	STD (6)	STD (7)					
Stacked installation	133 (1)	Option	Option						
Compressor thermal insulation	146					Option	Option	Option	Option
Knock-down electrical panel	147					Option	Option	CF	CF
Automatic transfer switch (free standing)	149					Option	Option	Option	Option
Inverter EN61800-3 class C2 compliant	150					Option	Option	CF	CF
Rubber pads	152					Option	Option	Option	Option
Daikin on site modem (with antenna)	155					Option	Option	Option	Option
Marine version	167					CF	CF		
Portable touch screen	169							Option	Option
Nitrogen holding charge on water side heat exchangers	170							Option	Option
Low brine version	174 (11)					Option	Option		
Hot gas bypass - HGBP	175							Option	Option
Safety high press SWITCH-NR FOR EN378-2	179							Option	Option

## Accessories - Water cooled chillers

Panels	Water-cooled chillers							
	EWQ-KB	EW_Q-G EW_Q_-L	EWWD-J	EWWD-VZ	EWWH-VZ	EWWD-DZ	EWWH-DZ	DWSC & DWDC
EKDICMPAB (a) (b) iCM Primary Basic		•	•	•	•	•	•	•
EKDICMPAL (a) (b) iCM Primary for evaporator peripherals Light		•	•	•	•	•	•	•
EKDICMPAF (a) (b) iCM Primary for evaporator peripherals Full		•	•	•	•	•	•	•
EKTSMS Temperature sensor for master/slave configuration		•						
EKRUMCL1 User Interface								

Serial Cards & Communication Modules	Water-cooled chillers							
	EWQ-KB	EW_Q-G EW_Q_-L	EWWD-J	EWWD-VZ	EWWH-VZ	EWWD-DZ	EWWH-DZ	DWSC & DWDC
EKAC200J Serial Card RS485/Modbus								•
EKACBAC Ethernet Card BACnet								
EKACLONP Serial Card LON FTT10								
EKACRS232 Serial Card RS232 Modem Interface (single unit only)								•
EKACWEB Web Server Card								•
EKACBACMSTP Serial Card BACnet MSTP								
EKACBACCERT Serial Card BACnet pre-loaded (centrifugal chillers)								•
EKACMSTPCERT Serial Card BACnet pre-loaded MSTP (centrifugal chillers)								•
EKCM200J ModBus RTU communication module		•	•	•	•	•	•	
EKCLON LON communication module		•	•	•	•	•	•	
EKCMBACMSTP BACnet/MSTP communication module		•	•	•	•	•	•	
EKCMBACIP BACnet/IP communication module		•	•	•	•	•	•	

Other Systems & Accessories	Water-cooled chillers							
	EWQ-KB	EW_Q-G EW_Q_-L	EWWD-J	EWWD-VZ	EWWH-VZ	EWWD-DZ	EWWH-DZ	DWSC & DWDC
EKCON Converter RS485 to RS232								•
EKCONUSB Converter RS485 to USB								•
EKMODEM Fixed modem								•
EKGSMOD GSM modem								•
EKRUPCJ Remote display kit								•
EKRUPCS Local/remote display HMI		•	•	•	•	•	•	
EKPWPROEXT PlantWatchPro I/O extension module for hardwiring and retrofit								•
EKGWWEB Gateway web (Ethernet LAN SNMP)								•
EKGWMODEM Gateway for modem								•
EKAC10C Address card for connection to BMS or Remote user interface	•							
EKRUMCA Remote installed user interface	•							
EKLS2 (d) Low noise kit 22/28/35/45/55/65 Hp-units	•							
ECB2MUBW (e) Controller kit	•							
ECB3MUBW (e) Controller kit	•							
EKRPIAHT (g) Digital input/output PCB								
EKRUAHTB (g) Remote user interface								
DTA104A62 (f) External control adapter								
BHGP26A1 (f) Digital pressure gauge kit								
EKQDP2M016 (g) Differential Pressure Sensor 4-20 mA 0-160 kPa		•	•	•	•	•	•	•
EKQDP2M020 (g) Differential Pressure Sensor 4-20 mA 0-250 kPa		•	•	•	•	•	•	•
EKQDP2M040 (g) Differential Pressure Sensor 4-20 mA 0-400 kPa		•	•	•	•	•	•	•
EKQDP2M060 (g) Differential Pressure Sensor 4-20 mA 0-600 kPa		•	•	•	•	•	•	•
EKDAPCONT Containerization of one unit		•	•	•	•	•	•	
EKDAPSTF Containerization of additional units in the same container		•	•	•	•	•	•	

**Notes:**

- (a) Price **does not** include commissioning of panel; if commissioning is required please refer to RN17-041
- (b) iCM panels work in **cooling mode only**; heat pump versions and total heat recovery options on A/C and W/C chillers **are not compatible**
- (c) in case you are ordering iCM panels please **contact factory**
- (d) For 45/55/65 Hp-units 2 pieces are needed
- (e) Only available for modular units (EWQ~KAW1M)
- (f) Price available in SAP system
- (g) Differential pressure sensor are specific for iCM panels in variable primary flow management



## Table of content

# Condenserless chiller

EWLQ-KBW1N	135
EWLQ-G-SS	136
EWLQ-L-SS	137
EWLD-J-SS	138
EWLD-I-SS	139
Options	140
Accessories	141

---

# Condenserless scroll chiller

- › One of the most compact units on the market:  
600mm x 600mm x 600mm
- › Low energy consumption
- › Low operating sound level
- › Easy installation and maintenance
- › Stainless steel plate heat exchanger
- › Low refrigerant volume
- › Standard integrated: pressure ports, flow switch, filter, shut-off valves and air purge
- › Advanced  $\mu C^2SE$  controller for direct connection to a Modbus based BMS or to a remote user interface



EWLQ-KBW1N

$\mu C^2SE$



› More information about EWLQ-KBW1N

Cooling Only				EWLQ-KBW1N	014	025	033	049	064
Cooling capacity	Nom.		kW	12,05	21,87	27,96	43,4	56,71	
Power input	Cooling	Nom.	kW	3,54	6,42	8,26	12,74	16,2	
EER				3,40	3,41	3,39	3,41	3,50	
Dimensions	Unit	Height	mm	600					
		Width	mm	600					
		Depth	mm	600				1.200	
Weight	Unit		kg	104	138	149	252	274	
Water heat exchanger - evaporator	Type			Braze plate					
	Water pressure drop	Cooling	Nom.	kPa	16,5	24,2	22,1	20	22,2
Compressor	Type			Driven vapour compression					
	Quantity			1			2		
Sound power level	Cooling	Nom.	dBA	64		71	67	74	
		Nom.	dBA	64		71	67	74	
Operation range	Evaporator	Cooling	Min.~Max.	°CDB		-10~20			
	Condenser	Cooling	Min.~Max.	°CDB		25~60			
Refrigerant	Type			R-410A					
	Circuits	Quantity		1			2		
Piping connections	Evaporator water inlet/outlet (OD)				G1"			G1" 1/2	
Power supply	Phase/Frequency/Voltage			Hz/V	3~/50/400				

# Condenserless multi-scroll chiller, standard efficiency, standard sound

- › Single refrigerant circuit (2 scroll compressors) with single evaporator
- › For chilled water production, to be combined with a remote condensing unit
- › Compact design to allow easy indoor installation or retrofit operations
- › Conceived for stacked installation of two single circuit units to reduce the footprint
- › High efficiency and reliable scroll compressor
- › Stainless steel plate heat exchanger



EWLQ-G-SS



› More information about EWLQ-G-SS

Cooling only		EWLQ-G-SS		090	100	120	130	150	170	190	210	240	300	360			
Cooling capacity	Nom.		kW	86,5	98,4	110	125	139	160	181	206	231	290	346			
Power input	Cooling	Nom.	kW	22,4	25,8	29,2	33,0	36,8	42,0	47,0	54,2	59,9	75,6	91,8			
Capacity control	Method																
	Minimum capacity		%	50,0	43,0	50,0	44,0	50,0	45,0	50,0	43,0	50,0	40,0	50,0			
EER				3,86	3,81	3,78	3,79	3,80	3,86	3,80	3,85	3,84	3,77				
Dimensions	Unit	Height	mm	1.066													
		Width	mm	928													
		Depth	mm	2.743													
Weight	Unit		kg	494	578	686	714	742	773	807	838	852	967	1.046			
	Operation weight		kg	525	615	729	760	791	826	863	901	916	1.044	1.134			
Water heat exchanger - evaporator	Type	Plate heat exchanger															
	Water volume		l	6	8	10	12	13	15	17	27	34					
	Water flow rate	Nom.	l/s	4,2	4,7	5,3	6,0	6,7	7,7	8,7	9,8	11,1	13,9	16,6			
Compressor	Water pressure drop	Cooling	Nom.	kPa	44	35	29	31	33	30	38	41					
	Type	Driven vapour compression															
Sound power level	Quantity	2															
	Cooling	Nom.	dB(A)	80	83	85	87	88	90	92	93						
Sound pressure level	Cooling	Nom.	dB(A)	64	67	69	70	72	74	76	77						
	Evaporator	Cooling	Min.-Max.	°CDB	-10~15												
Operation range	Condenser	Cooling	Min.-Max.	°CDB	30~60												
	Type / GWP	R-410A / 2.087,5															
Refrigerant	Circuits	Quantity		1													
	Evaporator water inlet/outlet (OD)			1" 1/2					2" 1/2					3"			
Piping connections	Unit	Starting current	Max	A	204	255	261	308	316	354	368	466	481,0	640	677		
	Running current	Cooling	Nom.	A	39	42	45	51	57	64	70	81	88	111	135		
		Max	A	59	66	72	80	88	102	116	131	145	183	221			
Power supply	Phase/Frequency/Voltage		Hz/V	3~/50/400													



# Condenserless multi-scroll chiller, standard efficiency, standard sound

- › Dual refrigerant circuit (4 scroll compressors) with single evaporator
- › For chilled water production, to be combined with a remote condensing unit
- › Compact design to allow easy indoor installation or retrofit operations
- › High efficiency and reliable scroll compressor
- › Stainless steel plate heat exchanger



EWLQ-L-SS



› More information about EWLQ-L-SS

Cooling only				EWLQ-L-SS	180	205	230	260	290	330	380	430	480	540	600	660	720					
Cooling capacity	Nom.		kW		173	197	224	249	279	317	361	409	459	511	571	624	676					
Power input	Cooling	Nom.	kW		44,3	51,1	57,9	65,6	73,2	83,8	93,5	108	119	135	152	168	184					
Capacity control	Method				Step																	
	Minimum capacity		%		25,0	21,0	25,0	22,0	25,0	23,0	25,0	21,0	25,0	22,0	20,0	18,0	25,0					
EER					3,91	3,86	3,87	3,79	3,81	3,78	3,86	3,79	3,84	3,78	3,76	3,71	3,67					
Dimensions	Unit	Height	mm		1.970																	
		Width	mm		928																	
		Depth	mm		2.801																	
Weight	Unit		kg		832	1.007	1.202	1.252	1.333	1.380	1.432	1.511	1.560	1.609	1.694	1.833	1.957					
	Operation weight		kg		894	1.081	1.292	1.345	1.436	1.486	1.547	1.638	1.690	1.741	1.844	1.990	2.120					
Water heat exchanger - evaporator	Type				Plate heat exchanger																	
	Water volume		l		19	22	29		35		41		49		62							
	Water flow rate	Nom.	l/s		8,3	9,5	10,7	11,9	13,4	15,2	17,3	19,6	21,9	24,5	27,3	29,9	32,4					
Compressor	Type	Cooling	Nom.	kPa	29																	
					Water pressure drop			25		20	25	22	29		36	45	44	52	62			
Sound power level	Cooling	Nom.	dB(A)	Driven vapour compression																		
				Quantity			4															
Sound pressure level	Cooling	Nom.	dB(A)	4																		
				Quantity			83	86	88	90	91		93	95		96						
Operation range	Evaporator	Cooling	Min.-Max.	°CDB	-10~15																	
					Condenser	Cooling	Min.-Max.	°CDB	30~60													
Refrigerant	Type / GWP	Circuits	Quantity	R-410A / 2.087,5																		
							2															
Piping connections	Evaporator water inlet/outlet (OD)	Unit	Starting current	Max	A	3"																
						Running current	Cooling	Nom.	A	263	320	333	388	403	456	484	597	626	785	822	860	898
										Max	A	118	131	144	160	175	205	232	262	290	328	366
Power supply	Phase/Frequency/Voltage		Hz/V		3~/50/400																	

# Condenserless screw chiller, standard efficiency, standard sound

- › Compact design to allow **easy indoor installation or retrofit operations**
- › Daikin semi-hermetic single screw stepless compressor
- › **High energy efficiency both at full and part load conditions**
- › Chilled water temperatures **down to -10°C** on standard unit
- › Optimised for use with **R-134a**
- › MicroTech III controller with superior control logic and easy interface



EWLD-J-SS

MicroTech III



› More information about EWLD-J-SS

Cooling only				EWLD-J-SS	110	130	145	165	235	195	265
Cooling capacity	Nom.		kW	110	128	142	163	236	191	264	
Power input	Cooling	Nom.	kW	31,2	38,4	43,8	50,4	66,0	56,0	75,3	
Capacity control	Method			Stepless							
	Minimum capacity		%	25,0							
EER				3,51	3,33	3,25	3,24	3,58	3,42	3,51	
Dimensions	Unit	Height	mm	1.020							
		Width	mm	913							
		Depth	mm	2.684							
Weight	Unit		kg	1.124	1.141	1.237	1.263	1.489	1.305	1.489	
	Operation weight		kg	1.138	1.159	1.253	1.281	1.518	1.327	1.518	
Water heat exchanger - evaporator	Type			Plate heat exchanger							
	Water volume		l	14	18	14	17	26	20	26	
	Water flow rate	Nom.	l/s	5,2	6,1	6,8	7,8	11,3	9,2	12,6	
Compressor	Water pressure drop	Cooling	Nom.	kPa	14	13	39	37	26	33	32
	Type			Driven vapour compression							
Sound power level	Quantity			1							
	Cooling	Nom.	dB(A)	89							
Sound pressure level	Cooling	Nom.	dB(A)	79							
	Operation range	Evaporator	Cooling	Min.-Max.	-10~-15						
Refrigerant	Condenser	Cooling	Min.-Max.	25~60							
	Type / GWP			R-134a / 1.430							
Piping connections	Circuits	Quantity		1							
	Evaporator water inlet/outlet (OD)		mm	76,2							
Unit	Maximum starting current		A	151		195		288	195	288	
	Nominal running current (RLA)	Cooling	A	52	62	72	81	107	91	120	
	Maximum running current		A	76	97	107	122	167	143	189	
Power supply	Phase/Frequency/Voltage		Hz/V	3~/50/400							

# Condenserless screw chiller, standard efficiency, standard sound

- › DX shell and tube evaporator – one pass refrigerant side for easy oil circulation and return
- › Stepless single-screw compressor
- › Standard electronic expansion valve
- › Optimised for use with R-134a



› More information about EWLD-I-SS

<b>Cooling only</b>		<b>EWLD-I-SS</b>																																				
		<b>320</b>	<b>400</b>	<b>420</b>	<b>500</b>	<b>600</b>	<b>650</b>	<b>750</b>	<b>800</b>	<b>850</b>	<b>900</b>	<b>950</b>	<b>C10</b>	<b>C11</b>	<b>C12</b>	<b>C13</b>	<b>C14</b>	<b>C15</b>	<b>C16</b>	<b>C17</b>																		
Cooling capacity	Nom.	kW																																				
Power input	Cooling	kW																																				
Capacity control	Method	Stepless																																				
	Minimum capacity	25,0					12,5					8,3																										
EER			3,93	3,89	3,88	3,79	3,80	3,82	3,86			3,81	3,69	3,64	3,83	3,79	3,80	3,74	3,68	3,63	2,415																	
	Dimensions	Unit	1.899				1.464				2.325				2.135																							
		Height	3.114				4.391				4.426																											
Weight	Unit	1.861		1.869		1.884		3.331		3.339		3.347		3.356		3.364		3.412		5.146		5.167		5.188		5.208												
	Operation weight	2.054		2.052		2.056		3.602		3.603		3.604		3.605		3.645		5.667		5.671		5.677		5.680														
Water heat exchanger - evaporator	Type	Single pass shell and tube																																				
	Water volume	193		183		172		271		263		256		248		241		233		504		489		472		504		489		472								
	Water flow rate	15,1		17,9		20,9		24,4		29,1		32,1		35,4		38,4		41,4		44,8		46,7		49,3		52,5		54,8		57,9		61,2		63,7		66,1		68,6
Compressor	Type	Driven vapour compression																																				
	Quantity	1					2					3																										
Sound power level	Cooling	94		97		98		99		100		101		103																								
Sound pressure level	Cooling	75		76		78		79		80		81		83																								
Operation range	Evaporator	Cooling	Min.-Max.		°CDB																																	
	Condenser	Cooling	Min.-Max.		°CDB																																	
Refrigerant	Type / GWP	R-134a / 1.430																																				
	Circuits	1					2					3																										
Piping connections	Evaporator water inlet/outlet (OD)	mm																																				
	Unit	330		464		493		627		650		681		703		836		867		898		920		942														
	Nominal running current (RLA)	131		157		181		214		260		287		313		338		361		391		420		448		470		493		517		542		571		601		631
Maximum running current	204		233		271		299		407		436		465		504		542		570		597		670		698		737		775		814		841		868		896	
Power supply	Phase/Frequency/Voltage	Hz/V																																				
		3~/50/400																																				

## Options - Condenserless chillers

### Options - Small condenserless chillers

Chiller series	LWE	
	High Glycol	Low Glycol
	OPZH	OPZL
EWLQ-KBW1N	Option	Option

(1) Impossible option combination: OPZH+OPZL

### Options - Medium and large chillers

Description	Code	EWLQ-G	EWLQ-L	EWLD-J	EWLD-I
Direct on line starter (DOL)	04	STD	STD		
WyeDelta compressor starter (YD)	05			STD	STD
Soft starter	06 (5)	Option	Option	Option	Option
Brine version	08	Option	Option	Option	Option
Double setpoint	10	STD	STD	STD	STD
Compressor thermal overload relays	11			OPTION	OPTION
Phase monitor	13			STD	STD
Under / Over voltage control	15			Option	Option
Control expansion pack (including under/ ver voltage control, setpoint reset, demand limit, alarm from external device, expansion card POL965)	15a	Option	Option		
Energy meter	16			Option	Option
Capacitors for power factor correction	17	Option	Option		Option
Current limit	19			OPTION	Option
Evaporator victaulic kit	20 (2)	STD	STD	STD	STD
Evaporator water side design pressure (10 Bar)	27				STD
20mm evaporator insulation	29	STD	STD	STD	Option
Evaporator flow switch	58	Option	Option	STD	Option
Condenser flow switch	59				
Electronic expansion valve	60	STD	STD	STD	STD
Discharge line shutoff valve	61			STD	Option
Suction line shutoff valve	62			STD	Option
High pressure side manometers	63			Option	Option
Low pressure side manometers	64			Option	Option
Hour run meter	68	STD	STD	STD	STD
General fault contactor	69	STD	STD		STD
Alarm from external device	70			STD	
Container Kit	71	OPTION	OPTION	OPTION	OPTION (8)
Rubber anti vibration mounts	75	Option	Option	Option	Option
Sound proof system (integral)	76-a (7)				Option
Sound proof system (compressor)	76-b (3)	Option	Option	Option	
Sound proof system (compressor jacket)	76c	Option	Option		
Setpoint reset, Demand limit and Alarm from external device	90			STD	STD
Double pressure relief valve with diverter	91	Option	Option	Option	Option
Compressors circuit breakers	95	Option	Option	Option	
Main switch interlock door	97	STD	STD	STD	STD
Emergency stop	98			STD	STD
Ground fault relay	102	Option	Option	Option	Option
Evaporator double flange kit	104				Option
Liquid receiver	105			Option	Option
Transport kit	112	Option	Option	Option	Option (9)
Water filter	115	Option	Option		
Evaporator single pump (low lift)	122	Option			
Evaporator single pump (high lift)	123	Option			
Discharge and suction line shut-off valve	126	Option	Option		
High and low pressure side manometers	127	Option	Option		
Master/slave	128	STD	STD		
Part winding start	132	STD (4)	STD (6)		
Stacked installation	133 (1)	Option			

CF = Contact the Factory - NA = Not available - STD = Standard - SO = Specify at Order entry  
Please check with the price list the option availability for each size and efficiency/sound version

(1) For stacked installation the opt. has to be selected for both unit

(2) Evaporator victaulic kit is complete with counter victaulic

(3) Sound proof system - compressor enclosure

(4) For EWLQ-G-SS range option 132 is available only for sizes 300 kW and 360 kW

(5) The order of soft starter will have an impact on the delivery time: please contact the Factory

(6) For EWLQ-L-SS range option 132 is available only for sizes 540 kW to 720 kW

(7) Soundproof cabinet will be supplied in a separate kit and not assembled. For better performance the cabinet will be integral kind (around the whole chiller, not only around the compressors). Cabinet assembly is not included in the supply

(8) Special Transport is required (flat rack truck and open top) for model sizes (\*), to be checked with list price

(9) Forklift loading-unloading operations are not allowed for model sizes (\*), to be checked with list price

## Accessories - Condenserless chillers

Panels	Condenserless chillers			
	EWLQ-KB	EW_Q-G EW_Q_-L	EWLD-J	EWLD-I
EKDICMPAB (a) (b) iCM Primary Basic		•	•	•
EKDICMPAL (a) (b) iCM Primary for evaporator peripherals Light		•	•	•
EKDICMPAF (a) (b) iCM Primary for evaporator peripherals Full		•	•	•
EKTSMS Temperature sensor for master/slave configuration		•		
EKRUMCL1 User Interface				

Serial Cards & Communication Modules	Condenserless chillers			
	EWLQ-KB	EW_Q-G EW_Q_-L	EWLD-J	EWLD-I
EKAC200J Serial Card RS485/Modbus				
EKACBAC Ethernet Card BACnet				
EKACLONP Serial Card LON FTT10				
EKACRS232 Serial Card RS232 Modem Interface (single unit only)				
EKACWEB Web Server Card				
EKACBACMSTP Serial Card BACnet MSTP				
EKACBACCERT Serial Card BACnet pre-loaded (centrifugal chillers)				
EKACMSTPCERT Serial Card BACnet pre-loaded MSTP (centrifugal chillers)				
EKCM200J ModBus RTU communication module		•	•	•
EKCM LON LON communication module		•	•	•
EKCM BACMSTP BACnet/MSTP communication module		•	•	•
EKCM BACIP BACnet/IP communication module		•	•	•

Other Systems & Accessories	Condenserless chillers			
	EWLQ-KB	EW_Q-G EW_Q_-L	EWLD-J	EWLD-I
EKCON Converter RS485 to RS232				
EKCONUSB Converter RS485 to USB				
EKMODEM Fixed modem				
EKGSMOD GSM modem				
EKRUPCJ Remote display kit				
EKRUPCS Local/remote display HMI		•	•	•
EKPWPROEXT PlantWatchPro I/O extension module for hardwiring and retrofit				
EKGWWEB Gateway web (Ethernet LAN SNMP)				
EKGWMODEM Gateway for modem				
EKAC10C Address card for connection to BMS or Remote user interface	•			
EKRUMCA Remote installed user interface	•			
EKLS2 (d) Low noise kit 22/28/35/45/55/65 Hp-units	•			
ECB2MUBW (e) Controller kit				
ECB3MUBW (e) Controller kit				
EKRPIAHT (g) Digital input/output PCB				
EKRUAHTB (g) Remote user interface				
DTA104A62 (f) External control adapter				
BHGP26A1 (f) Digital pressure gauge kit				
EKQDP2M016 (g) Differential Pressure Sensor 4-20 mA 0-160 kPa		•	•	•
EKQDP2M020 (g) Differential Pressure Sensor 4-20 mA 0-250 kPa		•	•	•
EKQDP2M040 (g) Differential Pressure Sensor 4-20 mA 0-400 kPa		•	•	•
EKQDP2M060 (g) Differential Pressure Sensor 4-20 mA 0-600 kPa		•	•	•
EKDAPCONT Containerization of one unit		•	•	•
EKDAPSTF Containerization of additional units in the same container		•	•	•

### Notes:

- (a) Price **does not** include commissioning of panel; if commissioning is required please refer to RN17-041
- (b) iCM panels work in **cooling mode only**; heat pump versions and total heat recovery options on A/C and W/C chillers **are not compatible**
- (c) in case you are ordering iCM panels please **contact factory**
- (d) For 45/55/65 Hp-units 2 pieces are needed
- (e) Only available for modulare units (EWWQ~KAWIM)
- (f) Price available in SAP system
- (g) Differential pressure sensor are specific for iCM panels in variable primary flow management

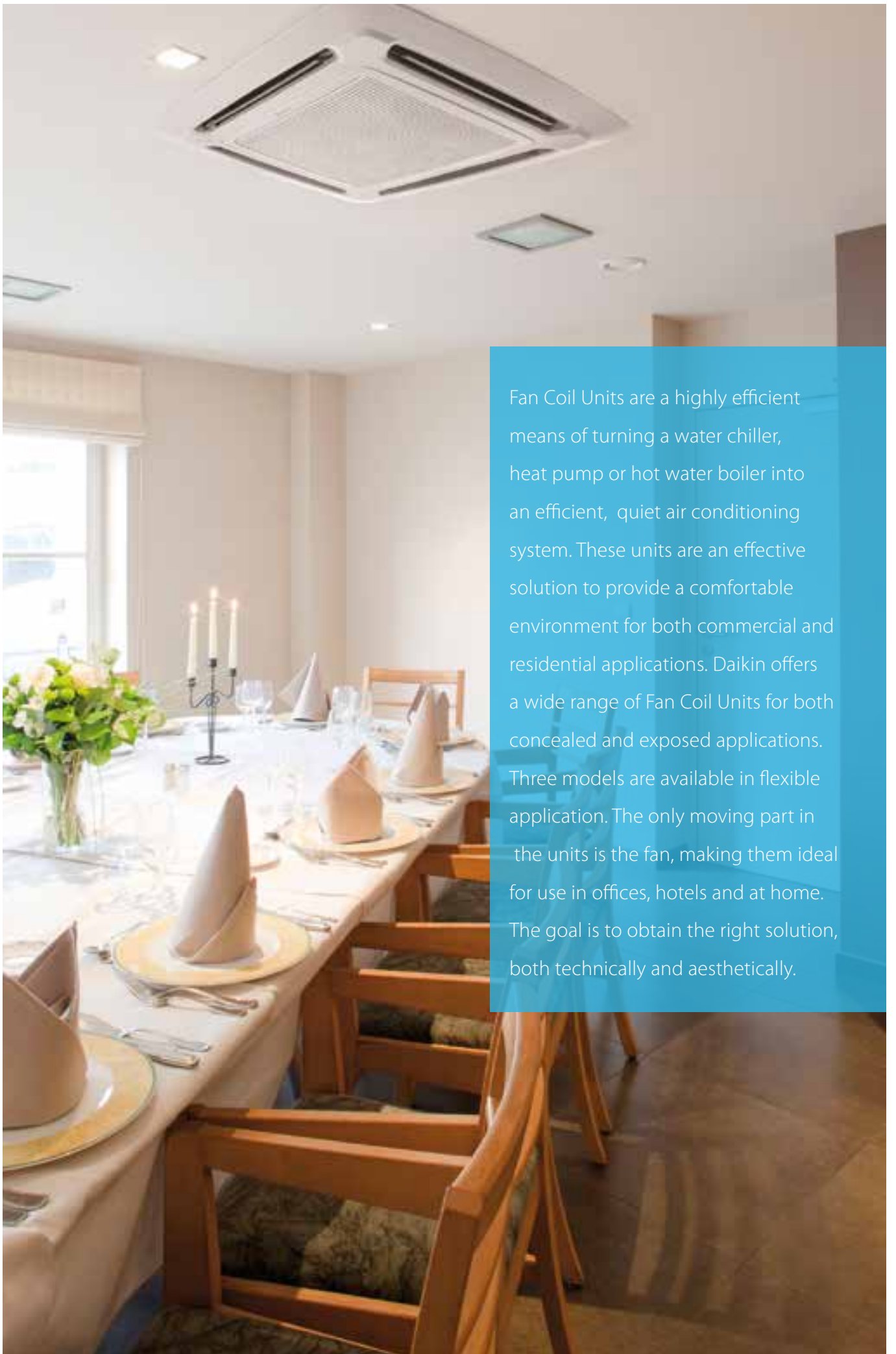

Fan Coil Units are a highly efficient means of turning a water chiller, heat pump or hot water boiler into an efficient, quiet air conditioning system. These units are an effective solution to provide a comfortable environment for both commercial and residential applications. Daikin offers a wide range of Fan Coil Units for both concealed and exposed applications. Three models are available in flexible application. The only moving part in the units is the fan, making them ideal for use in offices, hotels and at home. The goal is to obtain the right solution, both technically and aesthetically.

# Table of content

# Fan coil units

[Why choose Daikin fan coil units?](#) 144

[Products overview](#) 148

## Round flow cassette

---

FWC-BT/BF 150

## 4-way blow ceiling mounted cassettes

---

FWG-AT/AF 151

FWF-BT/BF 152

FWF-CT 153

## Floor standing units

---

FWZ-AT/AF 154

FWV-DAT/DAF 155

## Flexi type units

---

FWR-AT/AF 156

FWL-DAT/DAF 157

FWS-AT/AF 158

FWM-DAT/DAF 159

## Ducted units

---

FWE-CT/CF low ESP 160

FWP-AT medium ESP 161

FWB-BT medium ESP 162

FWN-AT/AF high ESP 163

FWD-AT/AF high ESP 164

## Wall mounted unit

---

FWT-CT 165

Options & accessories 166



## Fan coil units with BLDC motor

As more buildings undergo renovation, the need to be able to deliver high indoor air quality in a specific space in an **efficient and cost-effective way** without having to do a radical re-fit of the entire HVAC system has made fan coil technology an obvious solution.

Daikin has a full capacity range of **aesthetically pleasing** fan coil units with advanced controls that reliably deliver **excellent comfort levels**. And by using a refined range of advanced DC fan motors, we are able to offer flexibility while maintaining very low noise levels.

## Why choose Daikin fan coil units?

- The new brushless DC ranges reflect Daikin's commitment to developing highly efficient fan coil units that help to reduce energy consumption, without compromising on reliability and performance.
- High level quality is written large for us and we are pleased to offer high technology solutions to the market.

## Benefits for the installer

- › Reduced amount of sizes: less stock space needed
- › Modular designs for multiple configurations
- › Easy integration in BMS system via modbus protocol

## Benefits for the consultant

- › Best solution in the market in order to have top efficiency, best comfort and lowest sound levels
- › Product flexibility: wide range of options, accessories and controls

## Benefits for the end user

- › High comfort level
- › Up to 70% savings on running costs with a BLDC fan motor
- › Controller with timer programmed operating mode
- › FWECISA controller that can satisfy all customer requirements in terms of FCU management



## Fan coil unit software

- Select your unit via our selection software
- › Selection logic is based on cooling and/or heating mode conditions entered by the user
  - › A detailed report including technical specifications and wiring diagram can be printed.

Download the software from the business portal. Fan coil selection is available in the software finder.

## Payback tool

Prove quickly the saving in electric costs using the new BLDC motor technology compared to the AC motor technology via our payback tool. The tool can be downloaded from the business portal. Search for: BLDC payback tool

## BIM objects

Our Fan Coils units are available as BIM objects in Revit format, which means they can be used in Autodesk REVIT MEP and in AutoCAD 2D files. Visit our **BIM Application Suite**

## BLDC fan motors Video

Learn more on the advantages of BLDC fan motors in Fan coil units:



Check on  
**You Tube**  
[www.youtube.com/  
DaikinEurope](http://www.youtube.com/DaikinEurope)



## Benefits of brushless inverter technology on fan coil units:

### Higher efficiency than AC (Alternative Current) motor

- › Up to 70% energy savings
- › No heat generation
- › No power losses
- › Higher efficiency than AC motors to reach set point

### High comfort level

- › Less fluctuation of air temperature and relative humidity
- › More consistent output level
- › Stepless speed change for gradual air output
- › More accurate adjustments to reach set point

### Low sound levels

- › Lower minimum rotation speed
- › No start-stop sequence
- › Gradual air output

### High flexibility level

- › Multiple configurations: cassettes, floorstanding units, flexi type units with or without cabinet and ducted units
- › Wide capacity range in heating and cooling
- › Different piping topologies and connection valves



FWN-AT/AF



FWG-AT/AF



FWR-AT/AF



FWS-AT/AF



FWC-BT/BF



FWP-AT



FWZ-AT/AF

## Fan coil units



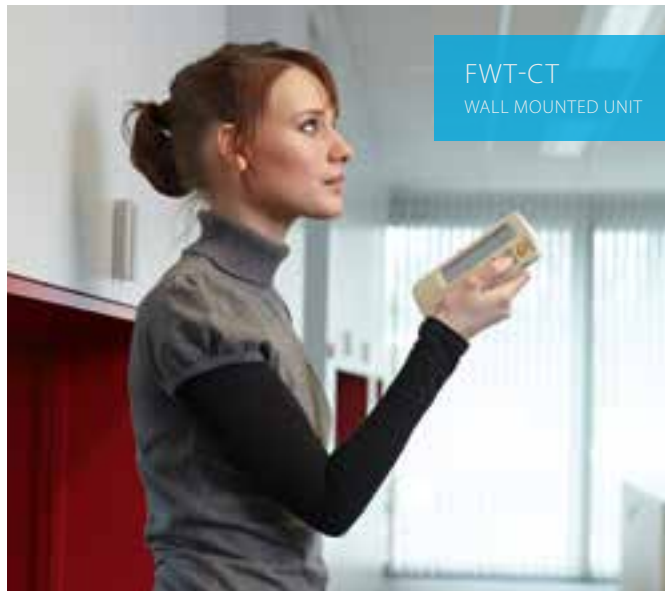

# Products overview

Type	Model	Product name	Fan motor type	Capacity
Round flow cassette	<p><b>Round flow cassette</b></p> <ul style="list-style-type: none"> <li>- 900 x 900 cassette</li> <li>- 360° air discharge ensures uniform air flow</li> <li>- Integrated fresh air intake</li> <li>- Easy installation in corners</li> <li>- Standard drain pump with 850 mm lift</li> </ul>	 <p>FWC-BT/BF</p> 	BLDC	Cooling: 4,0 - 8,7 kW Heating: 5,5 -12,1 kW
	<p><b>4-way blow ceiling mounted cassette</b></p> <ul style="list-style-type: none"> <li>- 900 x 900 cassette</li> <li>- High efficiency, continuous air flow regulation and fan speed modulation</li> <li>- Reduced sound emissions</li> <li>- Easy installation and maintenance</li> </ul>	<p>FWG-AT/AF</p> 	BLDC	Cooling: 2,0~ 11,75 kW Heating: 3,3~ 15,65 kW
4-way blow ceiling mounted cassette	<p><b>4-way blow ceiling mounted cassette</b></p> <ul style="list-style-type: none"> <li>- 600 x 600 cassette</li> <li>- Integrated fresh air intake</li> <li>- Horizontal auto swing</li> <li>- Easy installation in corners</li> <li>- Standard drain pump with 750 mm lift</li> </ul>	<p>FWF-BT/BF</p> 	AC	Cooling: 1,4 - 5,2 kW Heating: 2,3 - 6,7 kW
	<p><b>4-way blow ceiling mounted cassette</b></p> <ul style="list-style-type: none"> <li>- 600 x 600 cassette</li> <li>- Easy installation and maintenance</li> <li>- High power air flow</li> <li>- Standard drain pump with 700 mm lift</li> </ul>	<p>FWF-CT</p> 	AC	Cooling: 1,91 - 4,54 kW Heating: 2,64 - 5,28 kW
Floor standing units	<p><b>Floor standing unit</b></p> <ul style="list-style-type: none"> <li>- For vertical mounting</li> <li>- Continuous air flow regulation and fan speed modulation</li> <li>- Up to 70% energy savings</li> <li>- Low sound levels</li> </ul>	<p>FWZ-AT/AF</p> 	BLDC	Cooling: 2,64 - 10,08 kW Heating: 2,46 - 11,18 kW
	<p><b>Floor standing unit</b></p> <ul style="list-style-type: none"> <li>- For horizontal or vertical concealed mounting</li> <li>- Insulated valve packages, no extra drain pan required</li> <li>- Fast-on connections for electrical options: no tools needed</li> <li>- Easy maintenance</li> </ul>	<p>FWV-DAT/DAF</p> 	AC	Cooling: 1,46 - 8,02 kW Heating: 1,90 - 10,03 kW
Flexi type units	<p><b>Flexi type unit</b></p> <ul style="list-style-type: none"> <li>- For horizontal or vertical mounting</li> <li>- Continuous air flow regulation and fan speed modulation</li> <li>- Up to 70% energy savings</li> <li>- Low sound levels</li> </ul>	<p>FWR-AT/AF</p> 	BLDC	Cooling: 2,64 - 10,08 kW Heating: 2,46 - 11,18 kW
	<p><b>Flexi type unit</b></p> <ul style="list-style-type: none"> <li>- For horizontal or vertical concealed mounting</li> <li>- Insulated valve packages, no extra drain pan required</li> <li>- Fast-on connections for electrical options: no tools needed</li> <li>- Easy maintenance</li> </ul>	<p>FWL-DAT/DAF</p> 	AC	Cooling: 1,46 - 8,02 kW Heating: 1,90 - 10,03 kW
	<p><b>Concealed flexi type unit</b></p> <ul style="list-style-type: none"> <li>- For horizontal or vertical concealed mounting</li> <li>- Continuous air flow regulation and fan speed modulation</li> <li>- Up to 70% energy savings</li> <li>- Low sound levels</li> </ul>	<p>FWS-AT/AF</p> 	BLDC	Cooling: 2,64 - 10,08 kW Heating: 2,46 - 11,18 kW
	<p><b>Concealed flexi type unit</b></p> <ul style="list-style-type: none"> <li>- For horizontal or vertical concealed mounting</li> <li>- Insulated valve packages, no extra drain pan required</li> <li>- Fast-on connections for electrical options: no tools needed</li> <li>- Easy maintenance</li> </ul>	<p>FWM-DAT/DAF</p> 	AC	Cooling: 1,46 - 8,02 kW Heating: 1,90 - 10,03 kW
Ducted units	<p><b>Ducted unit with low ESP</b></p> <ul style="list-style-type: none"> <li>- For horizontal concealed mounting</li> <li>- Available static pressure up to 30 Pa</li> <li>- Easy installation and maintenance</li> <li>- 4-speed fan motor</li> <li>- High power air flow</li> </ul>	<p>FWE-CT/CF</p> 	AC	Cooling: 2,10 - 9,96 kW Heating: 2,3 - 13,00 kW
	<p><b>Ducted unit with medium ESP</b></p> <ul style="list-style-type: none"> <li>- For horizontal concealed mounting</li> <li>- Instant adjustment to temperature and relative humidity changes</li> <li>- Available static pressure up to 70 Pa</li> <li>- Low sound levels</li> </ul>	<p>FWP-AT</p> 	BLDC	Cooling: 2,61 - 6,47 kW Heating: 5,47 - 12,28 kW
	<p><b>Ducted unit with medium ESP</b></p> <ul style="list-style-type: none"> <li>- For horizontal concealed mounting</li> <li>- Available static pressure up to 60 Pa</li> <li>- 7-speed electrical motors (thermal protection on windings)</li> <li>- Easy maintenance</li> </ul>	<p>FWB-BT</p> 	AC	Cooling: 2,61 - 10,34 kW Heating: 5,47 - 18,78 kW
	<p><b>Ducted unit with medium ESP</b></p> <ul style="list-style-type: none"> <li>- For horizontal or vertical concealed mounting</li> <li>- Available static pressure up to 70 Pa</li> <li>- Easy maintenance</li> </ul>	<p>FWN-AT/AF</p> 	BLDC	Cooling: 2,83 - 8,75 kW Heating: 3,63 - 18,10 kW
	<p><b>Ducted unit with high ESP</b></p> <ul style="list-style-type: none"> <li>- For horizontal or vertical concealed mounting</li> <li>- Available static pressure from 60 up to 145 Pa</li> <li>- Easy maintenance</li> </ul>	<p>FWD-AT/AF</p> 	AC	Cooling: 3,90 - 18,30 kW Heating: 4,05 - 21,92 kW
Wall mounted unit	<p><b>Wall mounted unit</b></p> <ul style="list-style-type: none"> <li>- High aesthetic cabinet design</li> <li>- Optimum air distribution</li> <li>- Easy installation</li> <li>- 3-speed fan motor</li> </ul>	<p>FWT-CT</p> 	AC	Cooling: 2,43 - 5,28 kW Heating: 3,22 - 7,33 kW

	1	15	2	25	3	35	4	5	6	7	8	9	10	11	12	16	18
									•	•	•	•					
								•			•			•			
			•		•		•	•									
			•		•		•										
			•		•				•		•						
	•	•	•	•	•	•	•		•		•		•				
			•		•				•		•						
	•	•	•	•	•	•	•		•		•		•				
			•		•				•		•						
	•	•	•	•	•	•	•		•		•		•				
			•		•		•		•	•	•		•				
			•		•		•	•	•	•	•	•	•	•			
							•	•	•	•	•		•				
							•		•		•		•		•	•	•
			•		•		•	•	•								



# Round flow cassette

BLDC fan motor unit for ceiling mounting. 360° air discharge

- › 360° air discharge ensures uniform air flow and temperature distribution
- › Modern style decoration panel in white (RAL9010)
- › Optional fresh air intake
- › Comfortable horizontal air discharge ensures draughtfree operation and prevents ceiling soiling



- › Possibility to shut 1 or 2 flaps for easy installation in corners
- › Standard drain pump with 850mm lift increases flexibility and installation speed

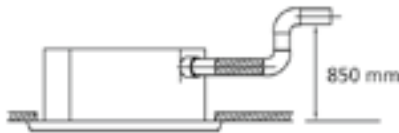

› More information about FWC-BT



› More information about FWC-BF

Indoor unit			FWC-BT/BF	06	07	08	09	06	07	08	09
				2-pipe				4-pipe			
Cooling capacity (standard conditions)	Total capacity	High	kW	5,5	6,1	7,2	8,1	5,9	6,3	7,2	8,3
		Medium	kW	4,7	5,3	5,9	6,8	5,1	5,6	6,2	6,9
		Low	kW	3,9	4,5	4,8	5,4	4,3	4,6	4,8	5,7
	Sensible capacity	High	kW	4,2	4,7	5,7	6,5	4,2	4,6	5,4	6,4
		Medium	kW	3,5	4,0	4,5	5,3	3,6	4,0	4,5	5,2
		Low	kW	2,8	3,3	3,5	4,1	3,1	3,3	3,5	4,0
Latent capacity	High	kW	1,3	1,4	1,5	1,6	1,7		1,8	1,9	
Heating capacity (standard conditions)	High	kW	6,8	7,7	9,2	10,6	6,9	7,8	9,2	10,4	
	Medium	kW	5,8	6,6	7,6	8,8	6,1	6,7	7,6	8,7	
	Low	kW	4,8	5,5	5,8	7,0	5,2	5,5	5,8	6,8	
Power input	High	kW	0,045	0,054	0,077	0,107	0,046	0,055	0,077	0,107	
	Medium	kW	0,040	0,046	0,058	0,076	0,041	0,047	0,059	0,077	
	Low	kW	0,034	0,037	0,039	0,045	0,035	0,038	0,040	0,046	
FCEER			116	119	113	104	124	120	112	106	
FCCOP			143	147	141	137	149	144	138	131	
Dimensions	Unit	HeightxWidthxDepth	mm	288x840x840							
Weight	Unit		kg	26				29			
Decoration panel	Dimensions	HeightxWidthxDepth	mm	95x999x1.008							
		Weight	kg	7							
Fan	Type			Turbo fan							
	Quantity			1							
	Air flow rate	High	m³/h	1.068	1.236	1.518	1.776	1.032	1.200	1.476	1.746
Medium		m³/h	894	1.038	1.200	1.410	864	1.002	1.164	1.374	
Low		m³/h	720	834	888	1.044	708	804	852	1.014	
Total sound power level	High	dBA	43,0	47,0	53,0	57,0	43,0	47,0	53,0	57,0	
	Medium	dBA	36,0	39,0	44,0	49,0	36,0	39,0	44,0	49,0	
	Low	dBA	31,0	33,0	36,0	40,0	33,0	36,0		40,0	
Sound pressure level	High	dBA	29,0	33,0	39,0	43,0	29,0	33,0	39,0	43,0	
	Medium	dBA	24,0	28,0	32,0	37,0	24,0	28,0	32,0	37,0	
	Low	dBA	21,0	22,0	24,0	28,0	21,0	22,0	24,0	28,0	
Piping connections	Drain	OD	mm	VP25 (External dia.32 / internal dia. 25)							
Power supply	Phase/Frequency/Voltage		Hz/V	1~/50/220-240							

# 4-way blow ceiling mounted cassette

BLDC fan motor unit for ceiling mounting. High efficiency, continuous air flow regulation and fan speed modulation

- › Up to 70% energy savings with brushless DC motor technology compared to traditional technology
- › Instant adjustment to temperature and relative humidity changes
- › Continuous modulation of fan speed resulting in reduced sound emissions, in comparison with fixed speed AC motor fan coil units
- › Easy installation and maintenance



› More information about FWG-AF



› More information about FWG-AT

Indoor unit				FWG-AT/AF			05	08	11	05	08	11
							2-pipe			4-pipe		
Cooling capacity (standard conditions)	Total capacity	High	kW	5,86	8,71	11,63	4,36	7,11	8,88			
		Medium	kW	4,63	7,20	9,62	3,58	6,05	7,67			
		Low	kW	3,49	5,77	7,81	2,79	4,97	6,46			
	Sensible capacity	High	kW	4,47	6,34	8,25	3,81	5,66	7,05			
		Medium	kW	3,42	5,36	6,89	2,97	4,80	5,98			
		Low	kW	2,53	4,23	5,50	2,23	3,78	4,86			
Latent capacity	High	kW	1,39	2,37	3,38	0,55	1,45	1,83				
Heating capacity (standard conditions)	High	kW	5,91	9,40	11,35	6,74	9,86	13,79				
	Medium	kW	4,83	7,52	9,51	5,47	8,51	11,82				
	Low	kW	3,73	5,95	7,66	4,45	7,09	10,09				
Power input	High	kW	0,047	0,100	0,130	0,047	0,100	0,130				
	Medium	kW	0,03	0,06	0,09	0,03	0,06	0,09				
	Low	kW	0,02	0,04	0,05	0,02	0,04	0,05				
FCEER				B			A	B				
FCCOP				B			A	B				
Dimensions	Unit	HeightxWidthxDepth	mm	265x820x820			300x820x820	265x820x820	268x820x820	300x820x820		
Weight	Unit			kg	26,0	28,0	32,0	26,0	28,0	32,0		
	Operation weight			kg	32	34	39	35	34	39		
Casing	Colour		Without powder paint									
Decoration panel	Dimensions	Unit	HeightxWidthxDepth	85x990x990								
	Weight			kg	4,0							
Heat exchanger	Water volume		l	1	2		1	2				
Air filter	Type		Washable Saranet									
Fan	Type		Turbo fan									
	Quantity		1									
	Air flow rate	High	m³/h	1.053	1.512	1.801	1.053	1.512	1.801			
Medium		m³/h	799	1.223	1.478	799	1.223	1.478				
Low		m³/h	595	951	1.155	595	951	1.155				
Total sound power level	High	dBA	46	57	59	46	57	59				
	Medium	dBA	40	52	55	40	52	55				
	Low	dBA	34	49		34	49					
Sound pressure level	High	dBA	37	47	51	37	47	51				
	Medium	dBA	31	42	46	31	42	46				
	Low	dBA	23	37	41	23	37	41				
Water flow	Cooling	High	l/h	1.030	1.530	2.040	770	1.250	1.570			
		Medium	l/h	1.030	1.530	2.040	770	1.250	1.570			
		Low	l/h	1.030	1.530	2.040	770	1.250	1.570			
	Heating	High	l/h	1.030	1.530	2.040	670	970	1.360			
		Medium	l/h	1.030	1.530	2.040	670	970	1.360			
		Low	l/h	1.030	1.530	2.040	670	970	1.360			
Piping connections	Drain	OD	mm 19									
Power supply	Phase/Frequency/Voltage		Hz/V	1N~/50/220-240								
Current input	High	A	0,26	0,74	0,95	0,26	0,74	0,95				
	Medium	A	0,19	0,43	0,55	0,19	0,43	0,55				
	Low	A	0,13	0,28	0,35	0,13	0,28	0,35				

# 4-way blow ceiling mounted cassette

AC fan motor unit for ceiling mounting.  
Possibility to shut 1 or 2 flaps

- › Modern style decoration panel in white (RAL9010)
- › Compact casing (570mm in width and depth) enables unit to fit flush into ceilings and match standard architectural modules, without cutting ceiling tiles
- › Comfortable horizontal auto swing ensures draughtfree operation and prevents ceiling soiling
- › Optional fresh air intake
- › Possibility to shut 1 or 2 flaps for easy installation in corners
- › Standard drain pump with 750mm lift increases flexibility and installation speed

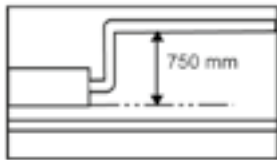

› More information about FWF-BT



› More information about FWF-BF



Indoor unit			FWF-BT/BF	02	03	04	05	02	03	04	05
				2-pipe				4-pipe			
Cooling capacity (standard conditions)	Total capacity	High	kW	1,7	3,0	4,0	4,9	1,8	2,9	3,8	4,6
		Medium	kW	1,5	2,7	3,1	4,0	1,5	2,4	3,1	3,8
		Low	kW	1,3	2,4	2,8	3,5	1,3	1,6	2,5	2,6
	Sensible capacity	High	kW	1,4	2,0	2,7	3,5	1,5	1,8	2,5	3,2
		Medium	kW	1,2	1,7	2,0	2,7	1,2	1,5	1,9	2,5
		Low	kW	1,0	1,4	1,8	2,4	1,0	1,3	1,6	2,1
Latent capacity	High	kW	0,3	1,0	1,3	1,4	0,3	1,1	1,3	1,4	
	Medium	kW	2,4	3,3	4,5	5,6	3,3	3,6	4,7	5,7	
	Low	kW	2,1	2,9	3,5	4,4	2,9	3,1	3,7	4,7	
Heating capacity (standard conditions)	High	kW	1,9	2,7	3,0	3,0	2,4	2,6	3,2	3,2	
	Medium	kW	0,074	0,090	0,118	0,074	0,094	0,121	0,093	0,093	
	Low	kW	0,067	0,070	0,089	0,067	0,062	0,074	0,093	0,093	
Power input	High	kW	0,060	0,055	0,062	0,060	0,055	0,066	0,066	0,066	
	Medium	kW	22	40	44	45	22	33	34	40	
	Low	kW	32	45	49	49	41	48	48	49	
FCEER											
FCCOP											
Dimensions	Unit	HeightxWidthxDepth	mm	285 x575x575							
Weight	Unit		kg	19				20			
Decoration panel	Dimensions	HeightxWidthxDepth	mm	95x999x1.008							
		Weight	kg	7							
Fan	Type			Turbo fan							
	Quantity			1							
	Air flow rate	High	m³/h	456	468	660	876	468	438	618	822
		Medium	m³/h	384	390	486	648	390	366	456	612
Low		m³/h	300	318	420	420	318	300	390	390	
Total sound power level	High	dB(A)	44,0	50,0	55,0	44,0	46,0	52,0	57,0		
	Medium	dB(A)	40,0	44,0	49,0	40,0	42,0	46,0	51,0		
	Low	dB(A)	36,0	38,0	42,0	36,0	38,0	41,0	44,0		
Sound pressure level	High	dB(A)	31,0	40,0	45,0	31,0	33,0	42,0	47,0		
	Medium	dB(A)	27,0	33,0	39,0	27,0	29,0	35,0	41,0		
	Low	dB(A)	26,0	30,0	26,0	27,0	27,0	32,0	32,0		
Piping connections	Drain	OD	mm	VP20 (External dia.26 / Internal dia. 20)							
Power supply	Phase/Frequency/Voltage	Hz/V		1~/50/220-440							



# 4-way blow ceiling mounted cassette

## AC fan motor unit for ceiling mounting

- › 4 way air discharge and air swing
- › Compact casing (570mm in width and depth) enables unit to fit flush into ceilings and match standard architectural modules, without cutting ceiling tiles
- › Wide operating range
- › Air suction from underneath
- › Easy installation and maintenance
- › Built-in high pressure drain pump with 700mm lift
- › Double-intake centrifugal fans
- › High power air flow
- › 3-speed fan motor
- › Infrared remote control as standard with decoration panel kit



› More information about FWF-CT

Indoor unit		FWF-CT		02	03	04
				2-pipe		
Cooling capacity (standard conditions)	Total capacity	High	kW	2,43	4,04	4,20
		Medium	kW	2,15	3,46	3,73
		Low	kW	1,86	2,73	3,11
	Sensible capacity	High	kW	1,85	2,87	3,09
		Medium	kW	1,62	2,37	2,70
		Low	kW	1,39	1,83	2,22
Latent capacity	High	kW	0,58	1,17	1,11	
Heating capacity (standard conditions)	High	kW	3,03	3,88	4,37	
	Medium	kW	2,50	3,08	3,40	
	Low	kW	2,08	2,18	2,91	
Power input	High	kW	0,063	0,064	0,079	
	Medium	kW	0,05	0,06	0,08	
	Low	kW		0,05	0,07	
Dimensions	Unit	HeightxWidthxDepth	mm	250x570x570		
Weight	Unit		kg	15,0	17,0	
	Operation weight		kg	19	21	
Decoration panel	Dimensions	Unit	HeightxWidthxDepth	45x460x460		
	Weight		kg	3,0		
Air filter	Type	Washable Saranet				
Fan	Type	Turbo fan				
	Quantity	1				
	Air flow rate	High	m <sup>3</sup> /h	646	680	748
		Medium	m <sup>3</sup> /h	493	527	664
Low		m <sup>3</sup> /h	391	374	476	
Total sound power level	High	dBA	52	54	56	
	Medium	dBA	45	47	56	
	Low	dBA	39	41	45	
Sound pressure level	High	dBA	42	45	48	
	Medium	dBA	35	38	40	
	Low	dBA	29	30	36	
Piping connections	Drain	OD	mm	19,05		
Power supply	Phase/Frequency/Voltage		Hz/V	1N~/50/220-240		
Current input	High	A		0,28		0,35
	Medium	A	0,23		0,25	0,32
	Low	A	0,21		0,24	0,31

# Floor standing unit

BLDC fan motor unit for vertical mounting. Continuous air flow regulation and fan speed modulation

- › Up to 70% energy savings with brushless DC motor technology compared to traditional technology
- › Instant adjustment to temperature and relative humidity changes
- › Low operating sound level
- › Highly flexible solutions: multiple sizes, piping topologies and connection valves
- › Requires very little installation space



› More information about FWZ-AT



› More information about FWZ-AF



Indoor unit			FWZ-AT/AF	02	03	06	02	03	06		
				2-pipe			4-pipe				
Cooling capacity (standard conditions)	Total capacity	High	kW	1,94	2,91	4,48	1,77	2,86	4,64		
		Medium	kW	1,69	2,37	3,64	1,55	2,32	3,79		
		Low	kW	1,35	1,75	2,99	1,25	1,72	3,10		
	Sensible capacity	High	kW	1,49	2,09	3,62	1,44	2,06	3,54		
		Medium	kW	1,30	1,69	2,90	1,21	1,65	2,85		
		Low	kW	1,04	1,25	2,31	0,97	1,23	2,27		
Heating capacity (standard conditions)	Latent capacity	High	kW	0,54	0,82	0,98	0,33	0,80	1,19		
		High	kW	2,15	2,94	4,88	1,76	2,68	4,64		
		Medium	kW	1,81	2,37	4,11	1,56	2,31	4,07		
Power input	Low	High	kW	0,019	0,016	0,033	0,019	0,016	0,033		
		Medium	kW	0,01		0,02	0,01		0,02		
		Low	kW	0,01			0,01				
FCEER				B	A			B	A		
FCCOP				B	A			B	A		
Dimensions	Unit	HeightxWidthxDepth	mm	564x774x226	564x984x226	564x1.190x226	564x774x226	564x984x226	564x1.190x226		
Weight	Unit				kg	20,6	26,7	32,3	20,6	26,7	32,3
Casing	Colour				White - RAL9010						
Heat exchanger	Water volume				l						
Air filter	Type				Polypropylene net						
Fan	Type				Centrifugal						
	Quantity				1	2		1	2		
Air flow rate	High	High	m³/h	344	442	785	327	431	763		
		Medium	m³/h	271	341	605	261	332	593		
		Low	m³/h	211	241	470	205	237	460		
Total sound power level	High	High	dBA	50	48	56	50	47	58		
		Medium	dBA	44	42	49	44	41	53		
		Low	dBA	40	36	43	38	33	48		
Sound pressure level	High	High	dBA	45	43	51	45	42	54		
		Medium	dBA	39	37	44	39	36	48		
		Low	dBA	35	31	38	33	28	43		
Water flow	Cooling	High	l/h	337	503	774	307	493	802		
		Medium	l/h	292	408	628	267	400	654		
		Low	l/h	234	302	515	216	297	535		
	Heating	High	l/h	373	506	866	154	234	406		
		Medium	l/h	315	408	709	136	202	357		
		Low	l/h	260	301	575	119	165	311		
Electric heater	Power input				kW	1,5	1,6	2,0	1,5	1,6	2,0
Piping connections	Drain	OD				mm					
Power supply	Phase/Frequency/Voltage				Hz/V						

# Floor standing unit

## AC fan motor unit for vertical mounting

- › Quick fixing system for wall mounted installation
- › Pre-assembled 3-way/4-port on/off valves are available
- › Valve packages are insulated, no extra drain pan required
- › Valve packages contain balancing valves and sensor pocket
- › Fast-on connections for electrical options: no tools needed
- › The air filter can easily be removed for cleaning
- › Electric heater: no relay up to 2kW capacity
- › Electric heater: equipped with two overheat cut-out thermostats



› More information about FWV-DAT



› More information about FWV-DAF



Indoor unit			FWV-DAT/DAF																			
			2-pipe										4-pipe									
			01	15	02	25	03	35	04	06	08	10	01	15	02	25	03	35	04	06	08	10
Cooling capacity (standard conditions)	Total capacity	High	kW																			
		Medium	kW																			
		Low	kW																			
	Sensible capacity	High	kW																			
		Medium	kW																			
Low		kW																				
	Latent capacity	High	kW																			
Heating capacity (standard conditions)	High	kW																				
	Medium	kW																				
	Low	kW																				
Power input	High	kW																				
	Medium	kW																				
	Low	kW																				
FCEER			E					D					E					D				
FCCOP			E					D					E					D				
Dimensions	Unit	HeightxWidthxDepth	mm					mm					mm					mm				
Weight	Unit		kg					kg					kg					kg				
Casing	Colour		White - RAL9010																			
Heat exchanger	Water volume		l					l					l					l				
Additional heat exchanger	Water volume		l					l					l					l				
Air filter	Type		Polypropylene net																			
Fan	Type		Centrifugal																			
	Quantity		1					2					1					2				
	Air flow rate	High	m³/h																			
Medium		m³/h																				
Low		m³/h																				
Total sound power level	High	dBA																				
	Medium	dBA																				
	Low	dBA																				
Sound pressure level	High	dBA																				
	Medium	dBA																				
	Low	dBA																				
Water flow	Cooling	High	l/h																			
		Medium	l/h																			
		Low	l/h																			
	Heating	High	l/h																			
		Medium	l/h																			
		Low	l/h																			
Electric heater	Power input		kW																			
Piping connections	Drain OD		mm																			
Power supply	Phase/Frequency/Voltage		Hz/V																			
Current input	High	A																				
	Medium	A																				
	Low	A																				

# Flexi type unit

BLDC fan motor unit for horizontal or vertical mounting.  
Continuous air flow regulation and fan speed modulation

- › For wall or ceiling mounted installation: ideal solution for spaces with no false ceilings
- › Up to 70% energy savings with brushless DC motor technology compared to traditional technology
- › Instant adjustment to temperature and relative humidity changes
- › Low operating sound level
- › Highly flexible solutions: multiple sizes, piping topologies and connection valves
- › Requires very little installation space



› More information about FWR-AT



› More information about FWR-AF



Indoor unit			FWR-AT/AF	02	03	06	02	03	06	
				2-pipe			4-pipe			
Cooling capacity (standard conditions)	Total capacity	High	kW	1,94	2,91	4,48	1,77	2,86	4,64	
		Medium	kW	1,69	2,37	3,64	1,55	2,32	3,79	
		Low	kW	1,35	1,75	2,99	1,25	1,72	3,10	
	Sensible capacity	High	kW	1,49	2,09	3,62	1,44	2,06	3,54	
		Medium	kW	1,30	1,69	2,90	1,21	1,65	2,85	
		Low	kW	1,04	1,25	2,31	0,97	1,23	2,27	
Heating capacity (standard conditions)	Latent capacity	High	kW	0,54	0,82	0,98	0,33	0,80	1,19	
		High	kW	2,15	2,94	4,88	1,76	2,68	4,64	
		Medium	kW	1,81	2,37	4,11	1,56	2,31	4,07	
Power input	Low	kW	1,50	1,76	3,36	1,36	1,88	3,55		
	High	kW	0,019	0,016	0,033	0,019	0,016	0,033		
	Medium	kW	0,01		0,02	0,01		0,02		
FCEER				B	A			B	A	
FCCOP				B	A			B	A	
Dimensions	Unit	HeightxWidthxDepth	mm	564x774x246	564x984x246	564x1.190x246	564x774x246	564x984x246	564x1.190x246	
Weight	Unit			kg	21,2	27,5	33,6	21,2	27,5	33,6
Casing	Colour	White - RAL9010								
Heat exchanger	Water volume			l	1					
Air filter	Type	Polypropylene net								
Fan	Type	Centrifugal								
	Quantity				1	2		1	2	
	Air flow rate	High	m³/h	344	442	785	327	431	763	
		Medium	m³/h	271	341	605	261	332	593	
Low		m³/h	211	241	470	205	237	460		
Total sound power level	High	dBA	50	48	56	50	47	58		
	Medium	dBA	44	42	49	44	41	53		
	Low	dBA	40	36	43	38	33	48		
Sound pressure level	High	dBA	45	43	51	45	42	54		
	Medium	dBA	39	37	44	39	36	48		
	Low	dBA	35	31	38	33	28	43		
Water flow	Cooling	High	l/h	337	503	774	307	493	802	
		Medium	l/h	292	408	628	267	400	654	
		Low	l/h	234	302	515	216	297	535	
	Heating	High	l/h	373	506	866	154	234	406	
		Medium	l/h	315	408	709	136	202	357	
		Low	l/h	260	301	575	119	165	311	
Electric heater	Power input	kW	1,5	1,6	2,0	1,5	1,6	2,0		
Piping connections	Drain OD	mm	16							
Power supply	Phase/Frequency/Voltage	Hz/V	1~/50/230							

# Flexi type unit

## AC fan motor unit for horizontal or vertical mounting

- › Quick fixing system for wall or ceiling mounted installation
- › Pre-assembled 3-way/4-port on/off valves are available
- › Valve packages are insulated, no extra drain pan required
- › Valve packages contain balancing valves and sensor pocket
- › Fast-on connections for electrical options: no tools needed
- › The air filter can easily be removed for cleaning
- › Electric heater: no relay up to 2kW capacity
- › Electric heater: equipped with two overheat cut-out thermostats



› More information about FWL-DAT



› More information about FWL-DAF

Indoor unit			FWL-DAT/DAF																																												
			01	15	02	25	03	35	04	06	08	10	01	15	02	25	03	35	04	06	08	10																									
			2-pipe										4-pipe																																		
Cooling capacity (standard conditions)	Total capacity	High	kW																																												
		Medium	kW																																												
		Low	kW																																												
	Sensible capacity	High	kW																																												
		Medium	kW																																												
	Low	kW																																													
	Latent capacity	High	kW																																												
Heating capacity (standard conditions)	High	kW																																													
	Medium	kW																																													
	Low	kW																																													
Power input	High	kW																																													
	Medium	kW																																													
	Low	kW																																													
FCEER			E					D					E					D																													
FCCOP			E					D					E					D																													
Dimensions	Unit	HeightxWidthxD	mm					564x774x246					564x984x246					564x1.190x246					564x1.400x271					564x774x246					564x984x246					564x1.190x246					564x1.400x271				
Weight	Unit		kg																																												
Casing	Colour		White - RAL9010																																												
Heat exchanger	Water volume		l																																												
Additional heat exchanger	Water volume		l																																												
Air filter	Type		Polypropylene net																																												
Fan	Type		Centrifugal																																												
	Quantity																																														
Air flow rate	High		m³/h																																												
	Medium		m³/h																																												
	Low		m³/h																																												
Total sound power level	High		dBA																																												
	Medium		dBA																																												
	Low		dBA																																												
Sound pressure level	High		dBA																																												
	Medium		dBA																																												
	Low		dBA																																												
Water flow	Cooling	High	l/h																																												
		Medium	l/h																																												
		Low	l/h																																												
	Heating	High	l/h																																												
		Medium	l/h																																												
		Low	l/h																																												
Electric heater	Power input		kW																																												
Piping connections	Drain OD		mm																																												
Power supply	Phase/Frequency/Voltage		Hz/V																																												
Current input	High		A																																												
	Medium		A																																												
	Low		A																																												

# Concealed flexi type unit

BLDC fan motor unit for horizontal or vertical concealed mounting. Continuous air flow regulation and fan speed modulation

- › Blends unobtrusively with any interior décor: only the suction and discharge grilles are visible
- › Up to 70% energy savings with brushless DC motor technology compared to traditional technology
- › Instant adjustment to temperature and relative humidity changes
- › Low operating sound level
- › Highly flexible solutions: multiple sizes, piping topologies and connection valves



› More information about FWS-AT



› More information about FWS-AF



Indoor unit			FWS-AT/AF	02	03	06	02	03	06	
				2-pipe			4-pipe			
Cooling capacity (standard conditions)	Total capacity	High	kW	1,94	2,91	4,48	1,77	2,86	4,64	
		Medium	kW	1,69	2,37	3,64	1,55	2,32	3,79	
		Low	kW	1,35	1,75	2,99	1,25	1,72	3,10	
	Sensible capacity	High	kW	1,49	2,09	3,62	1,44	2,06	3,54	
		Medium	kW	1,30	1,69	2,90	1,21	1,65	2,85	
		Low	kW	1,04	1,25	2,31	0,97	1,23	2,27	
Latent capacity	High	kW	0,54	0,82	0,98	0,33	0,80	1,19		
Heating capacity (standard conditions)	High	kW	2,15	2,94	4,88	1,76	2,68	4,64		
	Medium	kW	1,81	2,37	4,11	1,56	2,31	4,07		
	Low	kW	1,50	1,76	3,36	1,36	1,88	3,55		
Power input	High	kW	0,019	0,016	0,033	0,019	0,016	0,033		
	Medium	kW		0,01	0,02		0,01	0,02		
	Low	kW				0,01				
FCEER				B	A			B	A	
FCCOP				B	A			B	A	
Dimensions	Unit	HeightxWidthxDepth	mm	535x584x224	535x794x224	535x1.000x224	535x584x224	535x794x224	535x1.000x224	
Weight	Unit		kg	16,9	22,1	26,6	16,9	22,1	26,6	
Heat exchanger	Water volume		l	1						
Air filter	Type	Polypropylene net								
Fan	Type	Centrifugal								
	Quantity			1	2			1	2	
Air flow rate	High	m³/h	344	442	785	327	431	763		
	Medium	m³/h	271	341	605	261	332	593		
	Low	m³/h	211	241	470	205	237	460		
Total sound power level	High	dBA	50	48	56	50	47	58		
	Medium	dBA	44	42	49	44	41	53		
	Low	dBA	40	36	43	38	33	48		
Sound pressure level	High	dBA	45	43	51	45	42	54		
	Medium	dBA	39	37	44	39	36	48		
	Low	dBA	35	31	38	33	28	43		
Water flow	Cooling	High	l/h	337	503	774	307	493	802	
		Medium	l/h	292	408	628	267	400	654	
		Low	l/h	234	302	515	216	297	535	
	Heating	High	l/h	373	506	866	154	234	406	
		Medium	l/h	315	408	709	136	202	357	
		Low	l/h	260	301	575	119	165	311	
Electric heater	Power input	kW	1,5	1,6	2,0	1,5	1,6	2,0		
Piping connections	Drain OD	mm	16							
Power supply	Phase/Frequency/Voltage	Hz/V	1~/50/230							

# Concealed flexi type unit

AC fan motor unit for horizontal or vertical concealed mounting

- › Quick fixing system for wall or ceiling mounted installation
- › Pre-assembled 3-way/4-port on/off valves are available
- › Valve packages are insulated, no extra drain pan required
- › Valve packages contain balancing valves and sensor pocket
- › Fast-on connections for electrical options: no tools needed
- › The air filter can easily be removed for cleaning
- › Electric heater: no relay up to 2kW capacity
- › Electric heater: equipped with two overheat cut-out thermostats



› More information about FWM-DAT



› More information about FWM-DAF

Indoor unit			FWM-DAT/DAF										FWM-DAF										
			01	15	02	25	03	35	04	06	08	10	01	15	02	25	03	35	04	06	08	10	
			2-pipe										4-pipe										
Cooling capacity (standard conditions)	Total capacity	High	kW																				
		Medium	kW																				
	Sensible capacity	Low	kW																				
		High	kW																				
		Medium	kW																				
Latent capacity	High	kW																					
	Low	kW																					
Heating capacity (standard conditions)	High	kW																					
	Medium	kW																					
	Low	kW																					
Power input	High	kW																					
	Medium	kW																					
	Low	kW																					
FCEER			E					D					E					D					
FCCOP			E					D					E					D					
Dimensions	Unit	HeightxWidthxDepth	535x584x224					535x794x224					535x1.000x224					535x1.210x249					
Weight	Unit		16,5					16,9					21,4					22,1					
Heat exchanger	Water volume		0					1					2					0					
Additional heat exchanger	Water volume		-																				
Air filter	Type		Polypropylene net																				
Fan	Type		Centrifugal																				
	Quantity		1					2					1					2					
	Air flow rate	High	m³/h	319 344 442 640 706 785 1.011 1.393 307 330 327 432 431 628 690 763 998 1.362																			
		Medium	m³/h	233 271 341 450 497 605 771 1.022 225 261 334 332 444 490 593 765 1.007																			
Low		m³/h	178 211 241 320 361 470 570 642 174 205 238 237 316 356 460 565 636																				
Total sound power level	High	dBA	47 49 50 48 52 53 56 61 67 45 49 50 48 47 53 56 58 60 66																				
	Medium	dBA	42 44 44 43 42 43 49 54 60 39 44 43 41 45 46 53 54 58																				
	Low	dBA	37 38 40 35 36 35 43 47 48 51 56 62 40 44 45 43 42 46 51 54 55 61																				
Sound pressure level	High	dBA	42 44 45 43 47 48 51 56 62 40 44 45 43 42 46 51 54 55 61																				
	Medium	dBA	37 39 38 37 38 44 49 55 34 39 38 36 38 41 48 49 53																				
	Low	dBA	32 33 35 30 31 30 38 42 44 28 33 29 28 29 32 43 41 43																				
Water flow	Cooling	High	l/h 264 299 337 415 503 602 743 774 1.152 1.376 250 291 307 409 493 594 730 802 1.138 1.352																				
		Medium	l/h 213 261 292 348 408 451 561 628 905 1.071 196 254 267 343 400 447 554 654 898 1.058																				
		Low	l/h 179 216 234 275 302 340 431 515 682 706 169 212 216 272 297 336 425 535 676 699																				
	Heating	High	l/h 317 320 373 469 506 704 736 866 1.129 1.455 146 154 222 234 368 334 406 610 643																				
		Medium	l/h 256 300 315 393 408 545 563 709 898 1.135 130 137 136 191 202 304 281 357 527 551																				
		Low	l/h 211 252 260 302 301 415 430 575 690 764 115 120 119 156 165 247 238 311 440 425																				
Electric heater	Power input	kW	1,0 1,5 1,6 2,0 3,0 1,0 1,5 1,6 2,0																				
Piping connections	Drain OD	mm	16																				
Power supply	Phase/Frequency/Voltage	Hz/V	1~/50/230																				
Current input	High	A	0,16 0,20 0,27 0,40 0,39 0,80 1,07 0,16 0,20 0,27 0,40 0,39 0,80 1,07																				
	Medium	A	0,11 0,14 0,20 0,29 0,28 0,57 0,78 0,11 0,14 0,20 0,29 0,28 0,57 0,78																				
	Low	A	0,09 0,11 0,14 0,19 0,39 0,54 0,09 0,11 0,14 0,19 0,39 0,54																				

# Concealed ceiling unit with low ESP

## AC fan motor unit for horizontal concealed mounting

- › Easy installation and maintenance
- › 4-speed fan motor
- › High power air flow
- › Wired electronic controllers range
- › Available static pressure up to 50Pa
- › Wide operating range
- › Standard left and right side water connection
- › Extended drain pan as standard
- › Factory mounted valve (both left and right side)
- › Nylon filter G2 class
- › Polyethylene insulation



› More information about FWE-CT



› More information about FWE-CF



Indoor unit			FWE-CT/CF															
			02	03	04	06	07	08	10	02	03	04	06	07	08	10		
			2-pipe						4-pipe									
Cooling capacity (standard conditions)	Total capacity	Super high	kW	2,17	3,22	4,34	6,06	6,83	7,84	9,96	2,10	3,16	3,98	6,05	6,78	7,79	9,91	
		High	kW	1,81	2,78	3,49	5,32	5,68	6,92	8,64	1,76	2,69	3,22	5,20	5,61	6,79	8,61	
		Medium	kW	1,60	2,45	2,96	4,56	4,94	6,07	7,51	1,56	2,36	2,70	4,47	4,91	5,98	7,49	
		Low	kW	0,90	1,40	1,80	2,80	3,10	3,90	4,90	0,85	1,40	1,63	2,72	3,10	3,88	4,88	
Sensible capacity		Super high	kW	1,61	2,44	3,27	4,55	4,83	6,02	7,58	1,55	2,37	3,19	4,49	5,16	5,91	7,45	
		High	kW	1,33	2,08	2,58	3,94	4,30	5,25	6,48	1,28	1,99	2,53	3,81	4,20	5,09	6,39	
		Medium	kW	1,16	1,82	2,16	3,34	3,71	4,56	5,57	1,13	1,73	2,10	3,23	3,64	4,44	5,49	
		Low	kW	0,70	1,20	1,40	2,10	2,50	3,10	3,70	0,66	1,18	1,35	2,02	2,47	3,05	3,65	
Latent capacity		Super high	kW	0,56	0,78	1,07	1,51	2,00	1,82	2,38	0,55	0,79		1,56	1,62	1,88	2,46	
		High	kW	0,48	0,70	0,91	1,38		1,67	2,16	0,48	0,70	0,69	1,39	1,41	1,70	2,22	
Heating capacity (standard conditions)		Super high	kW	2,38	3,66	4,77	6,48	7,96	9,00	11,08	2,02	3,11	4,01	5,43	6,69	7,50	9,15	
		High	kW	1,96	3,13	3,76	5,61	6,53	7,84	9,43	1,71	2,69	3,31	4,73	5,65	6,62	8,06	
		Medium	kW	1,72	2,74	2,81	4,73	5,62	6,78	8,08	1,54	2,41	2,83	4,13	5,03	5,91	7,10	
Power input		Super high	kW	0,046	0,069	0,083	0,119	0,163	0,181	0,230	0,046	0,069	0,083	0,119	0,163	0,181	0,230	
		High	kW	0,039	0,054	0,059	0,093	0,128	0,145	0,180	0,039	0,054	0,059	0,093	0,128	0,145	0,180	
		Medium	kW	0,03	0,05		0,07	0,11	0,12	0,15	0,03	0,05		0,07	0,11	0,12	0,15	
		Low	kW	0,03	0,04		0,06	0,09	0,10	0,12	0,03	0,04		0,06	0,09	0,10	0,12	
Dimensions	Unit	HeightxWidthxDepth	mm	253x590	253x590	253x590	253x590	253x590	253x590	253x590	253x590	253x590	253x590	253x590	253x590	253x590		
				x705	x875	x1.010	x1.210	x1.460	x1.560	x1.820	x705	x875	x1.010	x1.210	x1.460	x1.560	x1.820	
Weight	Unit	Operation weight	kg	17,0	20,2	23,7	28,4	36,7	39,1	45,5	18,1	21,6	25,3	30,1	39,7	41,4	48,9	
				17	20	24	28	37	39	46	18	22	25	30	40	41	49	
Casing	Colour		Metal															
Air filter	Type		Aluminium Frame PP Filter Net G2 Class															
Fan	Type		Centrifugal (Blade: Forward - curve)															
	Quantity		1				2				3				4			
	Air flow rate	Super high	m³/h	430	638	910	1.195	1.559	1.753	2.177	416	626	835	1.193	1.548	1.742	2.166	
		High	m³/h	311	518	619	926	1.188	1.413	1.735	302	501	571	905	1.173	1.386	1.729	
Medium		m³/h	238	385	413	630	851	1.016	1.202	232	371	377	618	846	1.001	1.199		
Low		m³/h	150	256	284	426	569	688	808	142	256	257	414	569	684	804		
Total sound power level		Super high	dBA	51	61	58	62		64	65	51	61	58	62		64	65	
		High	dBA	49	56	50	55	57	58	60	49	56	50	55	57	58	60	
		Medium	dBA	37	49	40	48	47	50		37	49	40	48	47	50		
		Low	dBA	31	38	32	39	38	41	40	31	38	32	39	38	41	40	
Sound pressure level		Super high	dBA	41	51	48	52		54	55	41	51	48	52		54	55	
		High	dBA	39	46	38	45	47	48	49	39	46	38	45	47	48	49	
		Medium	dBA	26	39	28	36	37	40	39	26	39	28	36	37	40	39	
		Low	dBA	21	28	22	29	27	31	29	21	28	22	29	27	31	29	
Water flow	Cooling	Super high	l/h	254	382	526	768	886	1.023	1.229	246	374	478	767	879	918	1.223	
		High	l/h	212	331	404	668	733	899	1.050	206	320	373	653	724	800	1.046	
		Medium	l/h	191	294	343	559	631	784	870	188	284	313	547	628	705	866	
		Low	l/h	115	184	209	327	388	497	565	109	184	193	319	388	459	563	
	Heating	Super high	l/h	449	692	899	1.216	1.562	1.757	2.085	334	515	658	881	1.153	1.243	1.501	
		High	l/h	370	592	707	1.051	1.279	1.531	1.773	280	445	540	764	970	1.094	1.318	
		Medium	l/h	326	518	593	821	970	1.172	1.520	253	398	460	664	861	974	1.156	
		Low	l/h	192	322	364	530	650	780	995	148	250	290	406	589	665	773	
Piping connections	Drain		OD															
Power supply	Phase/Frequency/Voltage		Hz/V															
Current input		Super high	A	0,21	0,31	0,37	0,53	0,73	0,81	1,03	0,21	0,31	0,37	0,53	0,73	0,81	1,03	
		High	A	0,17	0,24	0,26	0,43	0,58	0,65	0,78	0,17	0,24	0,26	0,43	0,58	0,65	0,78	
		Medium	A	0,15	0,21	0,22	0,33	0,47	0,52	0,65	0,15	0,21	0,22	0,33	0,47	0,52	0,65	
		Low	A	0,13	0,18	0,19	0,27	0,40	0,46	0,54	0,13	0,18	0,19	0,27	0,40	0,46	0,54	



## Concealed ceiling unit with medium ESP

BLDC fan motor unit for horizontal concealed mounting. Continuous air flow regulation and fan speed modulation

- › Blends unobtrusively with any interior décor: only the suction and discharge grills are visible
- › Up to 50% energy savings with brushless DC motor technology compared to traditional technology
- › Instant adjustment to temperature and relative humidity changes
- › Low operating sound level
- › Highly flexible solutions: multiple sizes, piping topologies and connection valves



› More information about FWP-AT

Indoor unit			FWP-AT	02	03	04	05	06	07
				2-pipe					
Cooling capacity (standard conditions)	Total capacity	High	kW	2,38	2,88	3,19	4,58	4,85	5,80
		Low	kW	1,35	1,51	1,69	2,23	2,58	2,86
	Sensible capacity	High	kW	1,71	1,96	2,13	3,23	3,44	3,93
		Low	kW	0,95	1,03	1,11	1,62	1,79	1,92
Latent capacity	High	kW	0,67	0,92	1,06	1,35	1,41	1,87	
	Low	kW	2,54	2,80	3,00	4,71	5,15	5,56	
Heating capacity (standard conditions)	High	kW	1,40	1,48	1,53	2,46	2,59	2,74	
	Low	kW		0,046			0,076		
Power input	High	kW		0,01				0,02	
	Low	kW							
FCEER							A		
FCCOP							A		
Dimensions	Unit	HeightxWidthxDepth	mm	551x1.040x239			551x1.390x239		
Weight	Unit		kg	26,0	27,0	29,0	35,0	37,0	39,0
Heat exchanger	Water volume		l	1		2			3
Air filter	Type			Acrylic fiber - Filtering class G2 (G3 on request)					
Fan	Type			Centrifugal					
	Quantity			1			2		
	Air flow rate	High	m <sup>3</sup> /h	371			722		
	Low	m <sup>3</sup> /h	184			283	331		
Total sound power level	High		dBA	58			60		
	Low		dBA	36	38		39		
Sound pressure level	High		dBA	53			55		
	Low		dBA	31	33		34		
Water flow	Cooling	High	l/h	418	502	555	799	847	1.009
		FLow	l/h	219	256	283	318	400	465
	Heating	High	l/h	442	486	521	819	898	969
		Low	l/h	242	256	265	372	448	469
Electric heater	Power input		kW	2,0			2,5		
Piping connections	Drain	OD	mm	17					
Power supply	Phase/Frequency		Hz	1~/50					

# Concealed ceiling unit with medium ESP

## AC fan motor unit for horizontal concealed mounting

- › Compact dimensions, can easily be mounted in a narrow ceiling void (unit height: 240mm)
- › 3, 4 or 6 stage row cooling coil
- › Drain pan to collect the condensate from: heat exchanger and regulating valves
- › 7-speed electrical motors (with thermal protection on windings)
- › All 7 speeds pre-wired in the factory in the terminal block of the switch box
- › The air filter can easily be removed for cleaning



› More information about FWB-BT

Indoor unit			FWB-BT	02	03	04	05	06	07	08	09	10
			<b>2-pipe</b>									
Cooling capacity (standard conditions)	Total capacity	High	kW	2,32	2,82	3,13	4,47	4,74	5,69	5,70	6,48	7,65
		Low	kW	1,33	1,49	1,67	2,17	2,52	2,80	3,83	4,26	4,94
	Sensible capacity	High	kW	1,65	1,90	2,07	3,12	3,33	3,82	3,90	4,39	5,02
		Low	kW	0,93	1,01	1,09	1,56	1,73	1,86	2,67	2,92	3,25
Latent capacity	High	kW	0,67	0,92	1,06	1,35	1,41	1,87	1,80	2,09	2,63	
	Low	kW	2,54	2,80	3,00	4,70	5,15	5,56	5,95	6,57	7,18	
Heating capacity (standard conditions)	High	kW	1,39	1,48	1,53	2,14	2,81	2,71	4,11	4,42	4,69	
	Low	kW	0,106		0,192		0,294					
Power input	High	kW	0,03		0,08		0,16					
	Low	kW	D		C		D		D			
FCEER			C		D		C		D			
FCCOP			D		C		D		D			
Dimensions	Unit	HeightxWidthxDepth	mm	551x1.040x239			551x1.390x239			551x1.740x239		
Weight	Unit		kg	26,0	27,0	29,0	35,0	37,0	39,0	47,0	49,0	53,0
Heat exchanger	Water volume		l	1	2		3		2	3	4	
Air filter	Type	Acrylic fiber - Filtering class G2 (G3 on request)										
Fan	Type	Centrifugal										
	Quantity	1			2			3				
	Air flow rate	High	m³/h	371			722			905		
	Low	m³/h	184			283		331		572		
Total sound power level	High	dBA	58			60			69			
	Low	dBA	36		38		39		53			
Sound pressure level	High	dBA	53			55			64			
	Low	dBA	31		33		34		48			
Water flow	Cooling	High	l/h	418	502	555	799	847	1.009	1.028	1.162	1.363
		Low	l/h	219	256	283	318	400	465	683	758	874
	Heating	High	l/h	442	486	521	819	898	969	1.040	1.148	1.256
		Low	l/h	242	256	265	372	448	469	714	768	815
Electric heater	Power input	kW	2,0		2,5		3,0					
Piping connections	Drain OD	mm			17							
Power supply	Phase/Frequency	Hz			1~/50							

# Concealed ceiling unit with high ESP

BLDC fan motor unit for horizontal or vertical mounting. Continuous air flow regulation and fan speed modulation

- › Up to 70% energy savings with brushless DC motor technology compared to traditional technology
- › Instant adjustment to temperature and relative humidity changes
- › Low operating sound level
- › Highly flexible solutions: multiple sizes, piping topologies and connection valves
- › The air filter can easily be removed for cleaning
- › Straight duct connector mounted to discharge side



› More information about FWN-AT



› More information about FWN-AF



Indoor unit			FWN-AT/AF	04	05	06	07	08	10	04	05	06	07	08	10						
				2-pipe						4-pipe											
Cooling capacity (standard conditions)	Total capacity	High	kW	3,80	4,65	6,01	6,65	7,57	8,49	3,76	4,61	5,91	6,55	7,46	8,35						
		Medium	kW	3,47	4,20	5,65	6,25	6,84	7,62	3,44	4,17	5,58	6,17	6,75	7,52						
		Low	kW	2,83	3,38	5,22	5,78	6,20	6,84	2,82	3,36	5,17	5,71	6,14	6,77						
	Sensible capacity	High	kW	2,98	3,56	4,47	5,04	6,29	6,83	2,95	3,53	4,39	4,97	6,19	6,71						
		Medium	kW	2,70	3,19	4,20	4,73	5,60	6,07	2,68	3,17	4,15	4,66	5,52	5,98						
		Low	kW	2,19	2,54	3,90	4,35	5,01	5,40	2,18	2,52	3,84	4,30	4,96	5,34						
				Latent capacity																	
Heating capacity (standard conditions)	High	High	kW	0,82	1,09	1,54	1,61	1,28	1,66	0,81	1,08	1,52	1,58	1,27	1,64						
		Medium	kW	4,05	4,83	6,42	7,26	7,88	8,93	3,91	3,89	5,72	5,65	7,99	7,94						
		Low	kW	3,69	4,36	6,03	6,80	7,11	8,04	3,68	3,66	5,51	5,45	7,47	7,44						
Power input	High	High	kW	0,112		0,152		0,248		0,112		0,152		0,248							
		Medium	kW	0,07		0,13		0,17		0,73		0,13		0,17							
		Low	kW	0,04		0,10		0,12		0,45	0,40	0,10		0,12							
FCEER				C	B	C			B			C									
FCCOP				B	A	B			B			C									
Dimensions	Unit	HeightxWidthxDepth	mm	559x754x280			559x964x280			559x1.170x280			559x754x280			559x964x280			559x1.170x280		
Weight	Unit		kg	32,5	33,3	40,6	41,7	47,3	48,7	34,7	35,5	43,2	44,4	50,3	51,7						
Heat exchanger	Water volume		l	1			2			1			2			3					
Additional heat exchanger	Water volume		l				-						1								
Air filter	Type			Acrylic - Filtering class EU2																	
Fan	Type			Centrifugal																	
	Quantity			1			2			1			2								
Air flow rate	High	High	m³/h	802	791	1.238	1.203	1.606	1.581	793	783	1.211	1.182	1.576	1.550						
		Medium	m³/h	700	692	1.134	1.107	1.384	1.371	694	686	1.115	1.088	1.362	1.349						
		Low	m³/h	534	532	1.019	1.000	1.207	1.198	531	529	1.005	985	1.192	1.184						
Total sound power level	High	High	dBA	66			69			72			66			69			72		
		Medium	dBA	61			63			67			61			63			67		
		Low	dBA	54	59	61	62			54			59	61	62						
Sound pressure level	High	High	dBA	61			64			67			61			64			67		
		Medium	dBA	56			58			62			56			58			62		
		Low	dBA	49	54	56	57			49			54	56	57						
Water flow	Cooling	High	l/h	671	817	1.059	1.169	1.344	1.501	666	810	1.040	1.148	1.322	1.476						
		Medium	l/h	607	732	990	1.093	1.202	1.336	602	727	978	1.079	1.187	1.319						
		Low	l/h	493	587	915	1.008	1.085	1.197	491	584	904	998	1.075	1.185						
	Heating	High	l/h	705	840	1.114	1.259	1.369	1.551	342	340	501	496	700	695						
		Medium	l/h	641	758	1.048	1.183	1.236	1.397	322	320	483	477	654	651						
		Low	l/h	529	617	972	1.094	1.124	1.264	283	460	456	614	612							
Electric heater	Power input	kW	2,0			6,0			9,0			2,0			6,0			9,0			
Piping connections	Drain OD	mm	17																		
Power supply	Phase/Frequency/Voltage	Hz/V	1~/50/230																		

# Concealed ceiling unit with high ESP

AC fan motor unit for horizontal concealed mounting

- › Quick fixing system for wall or ceiling mounted installation
- › Straight duct connector mounted to discharge side
- › The air filter can easily be removed for cleaning



› More information about FWD-AT



› More information about FWD-AF

Indoor unit			FWD-AT/AF	04	06	08	10	12	16	18	04	06	08	10	12	16	18	
				2-pipe						4-pipe								
Cooling capacity (standard conditions)	Total capacity	High	kW	3,65	5,71	7,33	8,25	11,86	15,92	17,74	3,62	5,60	7,20	8,10	11,66	15,84	17,66	
		Medium	kW	3,36	5,39	6,63	7,41	10,12	13,83	15,36	3,33	5,32	6,54	7,31	10,00	13,77	15,29	
		Low	kW	2,74	4,99	6,03	6,68	8,42	11,63	12,92	2,73	4,92	5,97	6,61	8,33	11,59	12,87	
	Sensible capacity	High	kW	2,83	4,16	6,04	6,58	9,22	12,21	13,49	2,80	4,08	5,94	6,46	9,06	12,14	13,41	
		Medium	kW	2,59	3,94	5,39	5,86	7,75	10,43	11,40	2,57	3,89	5,31	5,77	7,66	10,38	11,34	
		Low	kW	2,10	3,66	4,84	5,23	6,35	8,61	9,37	2,09	3,60	4,79	5,17	6,29	8,58	9,34	
Latent capacity	High	kW	0,82	1,54	1,28	1,65	2,63	3,71	4,25	0,82	1,52	1,27	1,64	2,60	3,70	4,25		
	High	kW	4,05	6,42	7,88	8,93	12,72	17,29	19,05	3,91	5,72	7,99	7,94	14,43	19,30	19,20		
	Medium	kW	3,69	6,03	7,11	8,04	10,84	15,05	16,40	3,68	5,51	7,47	7,44	12,63	17,17	17,03		
Heating capacity (standard conditions)	Low	kW	3,04	5,59	6,47	7,28	9,06	12,68	13,73	3,23	5,25	7,02	6,99	10,86	14,88	14,79		
	High	kW	0,265	0,460	0,505	0,750	1,300	0,265	0,460	0,505	0,750	1,300						
	Medium	kW	0,19	0,39	0,38	0,54	1,09	0,19	0,39	0,38	0,54	1,09						
Power input	Low	kW	0,14	0,35	0,29	0,37	0,87	0,14	0,35	0,29	0,37	0,87						
	FCEER																	
	FCCOP																	
Dimensions	Unit	HeightxWidthxDepth	mm	559x754x280	559x964x280	559x1.170x280	718x1.170x353	718x1.380x353	559x754x280	559x964x280	559x1.170x280	718x1.170x353	718x1.380x353					
Weight	Unit		kg	32,5	40,6	47,3	48,7	65,3	77,0	79,5	34,7	43,2	50,3	51,7	70,9	83,4	85,9	
Heat exchanger	Water volume		l	1	2	3	5	6	1	2	3	5	6					
Additional heat exchanger	Water volume		l							1			2					
Air filter	Type	Acrylic fiber - Filtering class G2 (G4 on request)																
Fan	Type	Centrifugal																
	Quantity		1	2						1	2							
	Air flow rate	High	m³/h	802	1.241	1.609	1.584	2.380	3.206	3.175	794	1.212	1.573	1.550	2.328	3.186	3.155	
		Medium	m³/h	700	1.134	1.384	1.371	1.898	2.641	2.604	694	1.115	1.362	1.349	1.871	2.626	2.590	
Low		m³/h	534	1.021	1.208	1.200	1.485	2.092	2.073	532	1.004	1.194	1.186	1.466	2.084	2.065		
Total sound power level	High	dB(A)	66	69	72	74	78	66	69	72	74	78						
	Medium	dB(A)	61	63	67	73	61	64	67	73								
	Low	dB(A)	54	59	62	60	69	54	61	62	60	69						
Sound pressure level	High	dB(A)	61	64	67	69	73	61	64	67	69	73						
	Medium	dB(A)	56	58	62	68	56	59	62	68								
	Low	dB(A)	49	54	57	55	64	49	56	57	55	64						
Water flow	Cooling	High	l/h	671	1.059	1.344	1.501	2.163	2.953	3.270	666	1.040	1.322	1.476	2.130	2.940	3.254	
		Medium	l/h	607	990	1.202	1.336	1.827	2.561	2.823	602	978	1.187	1.319	1.808	2.550	2.811	
		Low	l/h	493	915	1.085	1.197	1.509	2.145	2.365	491	904	1.075	1.185	1.493	2.138	2.358	
	Heating	High	l/h	705	1.114	1.369	1.551	2.209	3.008	3.311	342	501	700	695	1.264	1.690	1.680	
		Medium	l/h	641	1.048	1.236	1.397	1.884	2.617	2.852	322	483	654	651	1.105	1.503	1.490	
		Low	l/h	529	972	1.124	1.264	1.573	2.203	2.389	283	460	614	612	950	1.302	1.295	
Electric heater	Power input	kW	2,0	6,0	9,0	12,0	2,0	6,0	9,0	12,0								
Piping connections	Drain OD	mm	17															
Power supply	Phase/Frequency/Voltage	Hz/V	1~/50/230															

# Wall mounted unit

## AC fan motor unit for wall mounting

- › High aesthetic cabinet design
- › Optimum air distribution
- › Easy to install
- › Wireless remote control up to 9 m distance
- › 3-speed fan motor
- › Wide operating range
- › Low operating sound level thanks to tangential fan
- › Insulated with self-extinguishing class 1 heat insulation
- › Removable washable air filter (self-extinguishing class 1)



› More information about FWT-CT

Indoor unit			FWT-CT	02	03	04	05	06
				<b>2-pipe</b>				
Cooling capacity (standard conditions)	Total capacity	High	kW	2,40	2,67	3,27	4,49	5,21
		Medium	kW	2,20	2,23	2,79	4,02	4,32
		Low	kW	1,94	2,02	2,52	3,76	4,04
	Sensible capacity	High	kW	1,82	1,99	2,60	3,38	4,03
		Medium	kW	1,73	1,69	2,21	3,00	3,52
		Low	kW	1,50	1,49	1,91	2,77	3,22
Latent capacity	High	kW	0,58	0,68	0,67	1,11	1,18	
Heating capacity (standard conditions)	High	kW	2,71	2,96	3,71	5,07	6,23	
	Medium	kW	2,41	2,62	3,29	4,51	5,38	
	Low	kW	2,06	2,25	2,75	4,03	4,83	
Power input	High	kW	0,031	0,032	0,042	0,053	0,072	
	Medium	kW	0,03		0,04	0,05	0,07	
	Low	kW	0,03		0,04	0,04	0,06	
FCEER				D		C		D
FCCOP				C				
Dimensions	Unit	HeightxWidthxDepth	mm	288x800x206			310x1.070x224	
Weight	Unit		kg	9,00			14,0	
	Operation weight		kg	10			15	
Casing	Colour	White						
Heat exchanger	Water volume		l	1				
Air filter	Type	Washable Saranet						
Fan	Type	Cross flow fan						
	Quantity	1						
	Air flow rate	High	m <sup>3</sup> /h	442	476	629	866	1.053
	Medium	m <sup>3</sup> /h	391	425	544	765	883	
	Low	m <sup>3</sup> /h	340	374	442	663	782	
Total sound power level	High		dB(A)	45	48	55		59
	Medium		dB(A)	41	44	50	51	54
	Low		dB(A)	36	39	45	47	51
Sound pressure level	High		dB(A)	34	35	42		46
	Medium		dB(A)	29	30	39	38	42
	Low		dB(A)	25		32	34	39
Water flow	Cooling	High	l/h	420	460	570	780	910
		Medium	l/h	420	460	570	780	910
		Low	l/h	420	460	570	780	910
	Heating	High	l/h	420	460	570	780	910
		Medium	l/h	420	460	570	780	910
		Low	l/h	420	460	570	780	910
Piping connections	Drain	OD	mm	19				
Power supply	Phase/Frequency/Voltage		Hz/V	1N~/50/220-240				
Current input	High		A	0,19	0,20	0,21	0,29	0,34
	Medium		A	0,18	0,20		0,26	0,32
	Low		A	0,17	0,19		0,25	0,31

## Options & accessories - Fan coil units

	INDOOR UNITS	FWG-AT/AF	FWC-BT/BF	FWF-BT/BF	FWF-CT	FWZ-AT/AF	FWV-DAT/DAF	FWR-AT/AF
Panels	Decoration panel 600x600 (2-pipe)			BYFQ60B3	DCP600TC <sup>(1)</sup>			
	Decoration panel 900x900 (2-pipe)	DCP900BTA <sup>(1)</sup>	BYCQ140C					
	Decoration panel 900x900 (4-pipe)	DCP900BFA <sup>(1)</sup>	BYCQ140C					
	Panel spacer for reducing required installation height		KDBQ44B60					
	Sealing member of air discharge outlet		KDBHQ55C140	KDBH44BA60				
	Rear panel					ERPVO2A6 (2 class) ERPVO3A6 (3 class) ERPVO6A6 (6 class) ERPVI0A6 (8 class)	ERPVO2A6 (1, 15 & 2 class) ERPVO3A6 (25 & 3 class) ERPVO6A6 (35, 4 & 6 class) ERPVI0A6 (8 & 10 class)	ERPVO2A6 (2 class) ERPVO3A6 (3 class) ERPVO6A6 (6 class) ERPVI0A6 (8 class)
	Air intake & discharge grille					EAIDF02A6 (2 class) EAIDF03A6 (3 class) EAIDF06A6 (6 class) EAIDF10A6 (10 class)	EAIDF02A6 (1, 15 & 2 class) EAIDF03A6 (25 & 3 class) EAIDF06A6 (35, 4 & 6 class) EAIDF10A6 (8 & 10 class)	EAIDF02A6 (2 class) EAIDF03A6 (3 class) EAIDF06A6 (6 class) EAIDF10A6 (10 class)
Individual control systems & network	Wired remote controller (standard)	BRC51A61	BRC315D	BRC315D	MERCA		FWEC1A	
	Wired remote controller (advanced)						FWEC2A	
	Wired remote controller (advanced Plus)					FWEC3A	FWEC3A	FWEC3A
	Wired remote controller (heat pump)				SRC-HPA			
	Wireless controller (heat pump)		BRC7F530	BRC7F532F				
	Controller electromechanical						ECFWMB6	
	Split controller - power control board					FWECSAP	FWECSAP	FWECSAP
	Split controller - control panel					FWECSAC	FWECSAC	FWECSAC
	On-board mounting kit					FWECKA	FWECKA	FWECKA
	Wall-mounting kit					FWFCKA	FWFCKA	FWFCKA
Centralised control systems	Central remote control		DCS302CA51	DCS302CA51				
	Unified ON/OFF control		DCS301BA51	DCS301BA51				
	Schedule timer		DST301BA51	DST301BA51				
Building Management System & Standard protocol interface	Intelligent Touch Manager		DCM601A5A	DCM601A5A				
	Intelligent Touch Controller		DCS601C51C	DCS601C51C				

1. Decoration panel code includes wireless controller

FWL-DAT/DAF	FWS-AT/AF	FWM-DAT/DAF	FWE-CT/CF	FWP-AT	FWB-BT	FWD-AT/AF	FWN-AT/AF	FWT-CT
ERPVO2A6 (1,15 & 2 class) ERPVO3A6 (25 & 3 class) ERPVO6A6 (35, 4 & 6 class) ERPVI0A6 (8 & 10 class)	ERPVO2A6 (2 class) ERPVO3A6 (3 class) ERPVO6A6 (6 class) ERPVI0A6 (8 class)	ERPVO2A6 (1,15 & 2 class) ERPVO3A6 (25 & 3 class) ERPVO6A6 (35,4 & 6 class) ERPVI0A6 (8&10 class)						
EAIDF02A6 (1, 15 & 2 class) EAIDF03A6 (25 & 3 class) EAIDF06A6 (35, 4 & 6 class) EAIDF10A6 (8 & 10 class)	EAIDF02A6 (2 class) EAIDF03A6 (3 class) EAIDF06A6 (6 class) EAIDF10A6 (10 class)	EAIDF02A6 (1, 15 & 2 class) EAIDF03A6 (25 & 3 class) EAIDF06A6 (35, 4 & 6 class) EAIDF10A6 (8 & 10 class)						
FWEC1A		FWEC1A	FWEC1A		FWEC1A	FWEC1A	FWEC1A	MERCA
FWEC2A		FWEC2A	FWEC2A		FWEC2A	FWEC2A	FWEC2A	
FWEC3A	FWEC3A	FWEC3A	FWEC3A	FWEC3A	FWEC3A	FWEC3A	FWEC3A	
								SRC-HPA
								WRC-HPC
ECFWMB6		ECFWMB6						
FWECSAP	FWECSAP	FWECSAP	FWECSAP	FWECSAP	FWECSAP	FWECSAP	FWECSAP	
FWECSAC	FWECSAC	FWECSAC	FWECSAC	FWECSAC	FWECSAC	FWECSAC	FWECSAC	
FWECKA	FWECKA	FWECKA						
FWFCKA	FWFCKA	FWFCKA	FWFCKA	FWFCKA	FWFCKA	FWFCKA	FWFCKA	

Options & accessories - Fan coil units

	INDOOR UNITS	FWG-AT/AF	FWC-BT/BF	FWF-BT/BF	FWF-CT	FWZ-AT/AF	FWV-DAT/DAF	FWR-AT/AF	
<b>Filters</b>	Long-life filter		KAFP551K160	KAFQ441BA60					
	3-ways 230V ON/OFF valve kit (2-pipe)	VKFWGA012T3V (5 & 8 class) VKFWGA022T3V (11 class)	EKMV3C09B	EKMV3C09B	MCKCW2T3VN	E2MV03A6 (2, 3 & 6 class) E2MV10A6 (8 class)	E2MV03A6 (1 up to 35 class) E2MV06A6 (4 & 6 class) E2MV10A6 (8 & 10 class)	E2MV03A6 (2, 3 & 6 class) E2MV10A6 (8 class)	
<b>ON/OFF valves 230V</b>	3-ways 230V ON/OFF valve kit (4-pipe)	VKFWGA014T3V (5 & 8 class) VKFWGA024T3V (11 class)	EKMV3C09B x2	EKMV3C09B x2		E4MV03A6 (2, 3 & 6 class) E4MV10A6 (8 class)	E4MV03A6 (1 up to 35 class) E4MV06A6 (4 & 6 class) E4MV10A6 (8 & 10 class)	E4MV03A6 (2, 3 & 6 class) E4MV10A6 (8 class)	
	2-ways 230V ON/OFF valve kit (2-pipe)		EKMV2C09B	EKMV2C09B					
	2-ways 230V ON/OFF valve kit (4-pipe)		EKMV2C09B x2	EKMV2C09B x2					
	2-ways 230V ON/OFF valve kit (cooling heat exchanger)					E2MV2B07A6 (2 up to 6 class) E2MV2B10A6 (8 class)	E2MV2B07A6 (1 up to 6 class) E2MV2B10A6 (8 & 10 class)	E2MV2B07A6 (2 up to 6 class) E2MV2B10A6 (8 class)	
	2-ways 230V ON/OFF valve kit (additional heat exchanger)					E2MV2B07A6	E2MV2B07A6	E2MV2B07A6	
	3-ways 230V ON/OFF valve kit (additional heat exchanger)								
	Simplified 3-ways 230V ON/OFF valve kit (2-pipe)					E2MVD03A6 (2 & 3 class) E2MVD06A6 (6 class) E2MVD10A6 (8 class)	E2MVD03A6 (1 up to 35 class) E2MVD06A6 (4 & 6 class) E2MVD10A6 (8 & 10 class)	E2MVD03A6 (2 & 3 class) E2MVD06A6 (6 class) E2MVD10A6 (8 class)	
	Simplified 3-ways 230V ON/OFF valve kit (4-pipe)					E4MVD03A6 (2 & 3 class) E4MVD06A6 (4 & 6 class) E4MVD10A6 (8 & 10 class)	E4MVD03A6 (1 up to 35 class) E4MVD06A6 (4 & 6 class) E4MVD10A6 (8 & 10 class)	E4MVD03A6 (2 & 3 class) E4MVD06A6 (4 & 6 class) E4MVD10A6 (8 & 10 class)	
	<b>ON/OFF valves 24V</b>	3-ways 24V ON/OFF valve kit (2-pipe)					E2M2V03A6 (2 & 3 class) E2M2V06A6 (6 class) E2M2V10A6 (8 class)	E2M2V03A6 (1 up to 35 class) E2M2V06A6 (4 & 6 class) E2M2V10A6 (8 & 10 class)	E2M2V03A6 (2 & 3 class) E2M2V06A6 (6 class) E2M2V10A6 (8 class)
		3-ways 24V ON/OFF valve kit (4-pipe)					E4M2V03A6 (2 & 3 class) E4M2V06A6 (6 class) E4M2V10A6 (8 class)	E4M2V03A6 (1 up to 35 class) E4M2V06A6 (4 & 6 class) E4M2V10A6 (8 & 10 class)	E4M2V03A6 (2 & 3 class) E4M2V06A6 (6 class) E4M2V10A6 (8 class)
2-ways 24V ON/OFF valve kit (cooling heat exchanger)						E2M2V207A6 (2, 3 & 6 class) E2M2V210A6 (8 class)	E2M2V207A6 (1 up to 35 class) E2M2V210A6 (8 & 10 class)	E2M2V207A6 (2, 3 & 6 class) E2M2V210A6 (8 class)	
2-ways 24V ON/OFF valve kit (additional heat exchanger)						E2M2V207A6	E2M2V207A6	E2M2V207A6	
<b>Proportional valves</b>	3-ways proportional valve kit (2-pipe)						E2MPV03A6 (1 up to 35 class) E2MPV06A6 (4 & 6 class) E2MPV10A6 (8 & 10 class)		
	3-ways proportional valve kit (4-pipe)						E4MPV03A6 (1 up to 35 class) E4MPV06A6 (4 & 6 class) E4MPV10A6 (8 & 10 class)		
	2-ways proportional valve kit (cooling heat exchanger)						E2MPV207A6 (1 up to 6 class) E2MPV210A6 (8 & 10 class)		
	2-ways proportional valve kit (additional heat exchanger)						E2MPV207A6		



FWL-DAT/DAF	FWS-AT/AF	FWM-DAT/DAF	FWE-CT/CF	FWP-AT	FWB-BT	FWD-AT/AF	FWN-AT/AF	FWT-CT
E2MV03A6 (1 up to 35 class) E2MV06A6 (4 & 6 class) E2MV10A6 (8 & 10 class)	E2MV03A6 (2, 3 & 6 class) E2MV10A6 (8 class)	E2MV03A6 (1 up to 35 class) E2MV06A6 (4 & 6 class) E2MV10A6 (8 & 10 class)	EK2MV3B10C5	E2MV107A6	E2MV107A6	ED2MV04A6 (4 class) ED2MV10A6 (6, 8 & 10 class) ED2MV12A6 (12 class) ED2MV18A6 (16 & 18 class)	ED2MV04A6 (4 & 5 class) ED2MV10A6 (6 up 10 class)	
E4MV03A6 (1 up to 35 class) E4MV06A6 (4 & 6 class) E4MV10A6 (8 & 10 class)	E4MV03A6 (2, 3 & 6 class) E4MV10A6 (8 class)	E4MV03A6 (1 up to 35 class) E4MV06A6 (4 & 6 class) E4MV10A6 (8 & 10 class)	EK2MV3B10C5			ED4MV04A6 (4 class) ED4MV10A6 (6, 8 & 10 class) ED4MV12A6 x 2 (12 class) ED4MV18A6 x 2 (16 & 18 class)	ED4MV04A6 (4 & 5 class) ED4MV10A6 (6 up 10 class)	
			EK2MV2B10C5					
			EK4MV2B10C5					
E2MV2B07A6 (1 up to 6 class) E2MV2B10A6 (8 & 10 class)	E2MV2B07A6 (2 up to 6 class) E2MV2B10A6 (8 class)	E2MV2B07A6 (1 up to 6 class) E2MV2B10A6 (8 & 10 class)			E2MV207A6 (2 up to 7 class) E2MV210A6 (8 & 10 class)			
E2MV2B07A6	E2MV2B07A6	E2MV2B07A6		E2MV207A6	E2MV207A0 (2 up to 7 class) E2MV210A6 (8 & 10 class)			
				E2MV307A6	E2MV307A6			
E2MVD03A6 (1 up to 35 class) E2MVD06A6 (4 & 6 class) E2MVD10A6 (8 & 10 class)	E2MVD03A6 (2 & 3 class) E2MVD06A6 (6 class) E2MVD10A6 (8 class)	E2MVD03A6 (1 up to 35 class) E2MVD06A6 (4 & 6 class) E2MVD10A6 (8 & 10 class)						
E4MVD03A6 (1 up to 35 class) E4MVD06A6 (4 & 6 class) E4MVD10A6 (8 & 10 class)	E4MVD03A6 (2 & 3 class) E4MVD06A6 (4 & 6 class) E4MVD10A6 (8 & 10 class)	E4MVD03A6 (1 up to 35 class) E4MVD06A6 (4 & 6 class) E4MVD10A6 (8 & 10 class)						
E2M2V03A6 (1 up to 35 class) E2M2V06A6 (4 & 6 class) E2M2V10A6 (8 & 10 class)	E2M2V03A6 (2 & 3 class) E2M2V06A6 (6 class) E2M2V10A6 (8 class)	E2M2V03A6 (1 up to 35 class) E2M2V06A6 (4 & 6 class) E2M2V10A6 (8 & 10 class)						
E4M2V03A6 (1 up to 35 class) E4M2V06A6 (4 & 6 class) E4M2V10A6 (8 & 10 class)	E4M2V03A6 (2 & 3 class) E4M2V06A6 (6 class) E4M2V10A6 (8 class)	E4M2V03A6 (1 up to 35 class) E4M2V06A6 (4 & 6 class) E4M2V10A6 (8 & 10 class)						
E2M2V207A6 (1 up to 35 class) E2M2V210A6 (8 & 10 class)	E2M2V207A6 (2,3 & 6 class) E2M2V210A6 (8 class)	E2M2V207A6 (1 up to 35 class) E2M2V210A6 (8 & 10 class)						
E2M2V207A6	E2M2V207A6	E2M2V207A6						
E2MPV03A6 (1 up to 35 class) E2MPV06A6 (4 & 6 class) E2MPV10A6 (8 & 10 class)		E2MPV03A6 (1 up to 35 class) E2MPV06A6 (4 & 6 class) E2MPV10A6 (8 & 10 class)						
E4MPV03A6 (1 up to 35 class) E4MPV06A6 (4 & 6 class) E4MPV10A6 (8 & 10 class)		E4MPV03A6 (1 up to 35 class) E4MPV06A6 (4 & 6 class) E4MPV10A6 (8 & 10 class)						
E2MPV207A6 (1 up to 6 class) E2MPV210A6 (8 & 10 class)		E2MPV207A6 (1 up to 6 class) E2MPV210A6 (8 & 10 class)						
E2MPV207A6		E2MPV207A6						

## Options & accessories - Fan coil units

	INDOOR UNITS	FWG-AT/AF	FWC-BT/BF	FWF-BT/BF	FWF-CT	FWZ-AT/AF	FWV-DAT/DAF	FWR-AT/AF
<b>Adapters</b>	Installation box/Mounting plate for adapter PCBs (when there is no space in the switchbox)		KRP1H98	KRP1BA101				
	Wiring adapter for electrical appendices		KRP2A52 <sup>(2)</sup> KRP4AA53 <sup>(2)</sup>	KRP2A52 <sup>(2)</sup> KRP4AA53 <sup>(2)</sup>				
	Remote ON/OFF			EKROROA				
	Remote sensor		KRCS01-4	KRCS01-1				
	Optional PCB for MODBUS connection		EKFCMBCB	EKFCMBCB				
	Wiring adapter with 4 output signals for valve control PDB		EKRP1C11					
	Temperature sensor kit					FWTSKA	FWTSKA	FWTSKA
	Relative humidity sensor kit					FWHSKA	FWHSKA	FWHSKA
	Fan stop thermostat						YFSTA6	
	Master-slave interface						EPIMSA6	
	Power interface							
<b>Others</b>	Fresh air intake kit (direct installation type)			KDDQ44XA60				
	Fresh air intake					EFA02A6 (2 class) EFA03A6 (3 class) EFA06A6 (6 class) EFA10A6 (8 class)	EFA02A6 (1, 15 & 2 class) EFA03A6 (25 & 3 class) EFA06A6 (35, 4 & 6 class) EFA10A6 (8 & 10 class)	EFA02A6 (2 class) EFA03A6 (3 class) EFA06A6 (6 class) EFA10A6 (8 class)
	Electrical box with earth terminal (2 blocks)		KJB212A	KJB212A				
	Electrical box with earth terminal (3 blocks)		KJB311A	KJB311A				
	Electrical box with earth terminal		KJB411A	KJB411A				
	Electric heater (standard)					EEH02A6 (2 class) EEH03A6 (3 class) EEH06A6 (6 class) EEH10A6 (8 class)	EEH01A6 (1 class) EEH02A6 (15 & 2 class) EEH03A6 (25 & 3 class) EEH06A6 (35, 4 & 6 class) EEH10A6 (8 & 10 class)	EEH02A6 (2 class) EEH03A6 (3 class) EEH06A6 (6 class) EEH10A6 (8 class)
	Electric heater (big)							
	Additional heat exchanger					ESRH02A6 (2 class) ESRH03A6 (3 class) ESRH06A6 (6 class) ESRH10A6 (8 class)	ESRH02A6 (1, 15 & 2 class) ESRH03A6 (25 & 3 class) ESRH06A6 (35, 4 & 6 class) ESRH10A6 (8 & 10 class)	ESRH02A6 (2 class) ESRH03A6 (3 class) ESRH06A6 (6 class) ESRH10A6 (8 class)
	Supporting feet					ESFV06A6 (2, 3 and 6 class) ESFV10A6 (8 class)	ESFV06A6 (1 up to 6 class) ESFV10A6 (8 & 10 class)	ESFV06A6 (2, 3 and 6 class) ESFV10A6 (8 class)
	Supporting feet and grille					ESFVG02A6 (2 class) ESFVG03A6 (3 class) ESFVG06A6 (6 class) ESFVG10A6 (8 class)	ESFVG02A6 (1, 15 & 2 class) ESFVG03A6 (25 & 3 class) ESFVG06A6 (35, 4 & 6 class) ESFVG10A6 (8 & 10 class)	ESFVG02A6 (2 class) ESFVG03A6 (3 class) ESFVG06A6 (6 class) ESFVG10A6 (8 class)
	Plenum box with circular connections							
	Vertical auxiliary drain pan					EDPVB6	EDPVB6	EDPVB6
	Horizontal auxiliary drain pan					EDPHB6	EDPHB6	EDPHB6
	Drain pump	included	included	included	included	CDRP1A	CDRP1A	CDRP1A (only vertical installation)

2. Requires KRP1H98





Daikin air handling units, with their plug-and-play design and inherent flexibility, can be configured and combined specifically to meet the exact requirements of any building, no matter what it is used for or who is to work there. Our systems are designed to be the most environmentally friendly and the most energy efficient on the market, thus reducing their ecological impact, while, at the same time, keeping costs down through the minimisation of energy consumption. When combined with the small physical footprint of the system, these features make our air handling units ideal for all markets.

# Table of content

# Air handling units

<b>Why choose Daikin air handling units?</b>	<b>174</b>
<b>Products overview</b>	<b>178</b>
Software and Eurovent certification	179
The working principle at a glance	180
D-AHU Professional	182
D-AHU Modular R	183
D-AHU Modular P	184
<b>NEW</b> D-AHU Modular L	185
Daikin fresh air package	186
Options	187

---



## Daikin air handling units

### Why choose Daikin air handling units?

- Maximum energy efficiency and indoor air quality
- Wide range of functions and options
- **High quality** components
- **Innovative** technology: Unique features and state of the art technology for short payback
- Operation **efficiency** and energy **savings**
- Outstanding **reliability** and **performance**
- Various applications are possible including air conditioning applications, industry-type process cooling, and large-scale district heat source systems.
- Plug and play concept for easy installation and commissioning
- Unique Daikin fresh air package available for connection of AHU to VRV or ERQ

### Benefits for the installer

- › Simple precise commissioning through pre-programmed DDC controller
- › Reduced installation time thanks to internal electrical wiring and external terminal connections avoiding drilling into unit panels
- › Flush mounted electrical control panel avoiding risk of damage during transport and installation

### Benefits for the consultant

- › Quick selection tool - in-house developed web software with improved user interface allowing for a professional report in a few clicks
- › Unlimited configuration options

### Benefits for the end user

- › Energy efficient controls, allowing the user to determine a wide range of settings, resulting in excellent operational flexibility
- › Safe operation - fully integrated electrical panel for units taller than 80cm
- › Amazing tailor made capability to meet the specific customer needs

## Marketing tools

- › Watch the time-lapse video of a Daikin AHU construction on [www.youtube.com/daikineurope](http://www.youtube.com/daikineurope)
- › Download our brochure on air handling units from [my.daikin.eu](http://my.daikin.eu)
- › Follow the wizard and select or modify your Modular or Professional AHU in a few clicks!



### Packaged control solution for Daikin AHU

- › Electrical control panel complete with Direct Digital Control (DDC) controller
- › Internal fitting of all sensors and pressure measurement devices
- › Built-in temperature, humidity and CO<sub>2</sub> sensors
- › Internal electrical wiring for all components

### Energy efficient while focusing on maximum comfort

- › Set points can be specified for supply, return or room temperature
- › Precise control of all AHU components such as mixing dampers, heat recovery wheels, water valves, pressure switches for filters and fans, fan motors and inverters

### Plug and play design

- › Low voltage fast connectors in between AHU sections

### Easy start-up and commissioning

- › Pre-programmed and factory-tested controls ensuring all wiring is installed correctly
- › Reduced energy and operating costs

### Daikin Fresh air package



- › Plug and play connection of Professional or Modular R AHU to Daikin VRV and ERQ
- › Factory mounted package contains a.o. expansion valve, electronic interface and sensors
- › Ensuring high efficiency and comfort

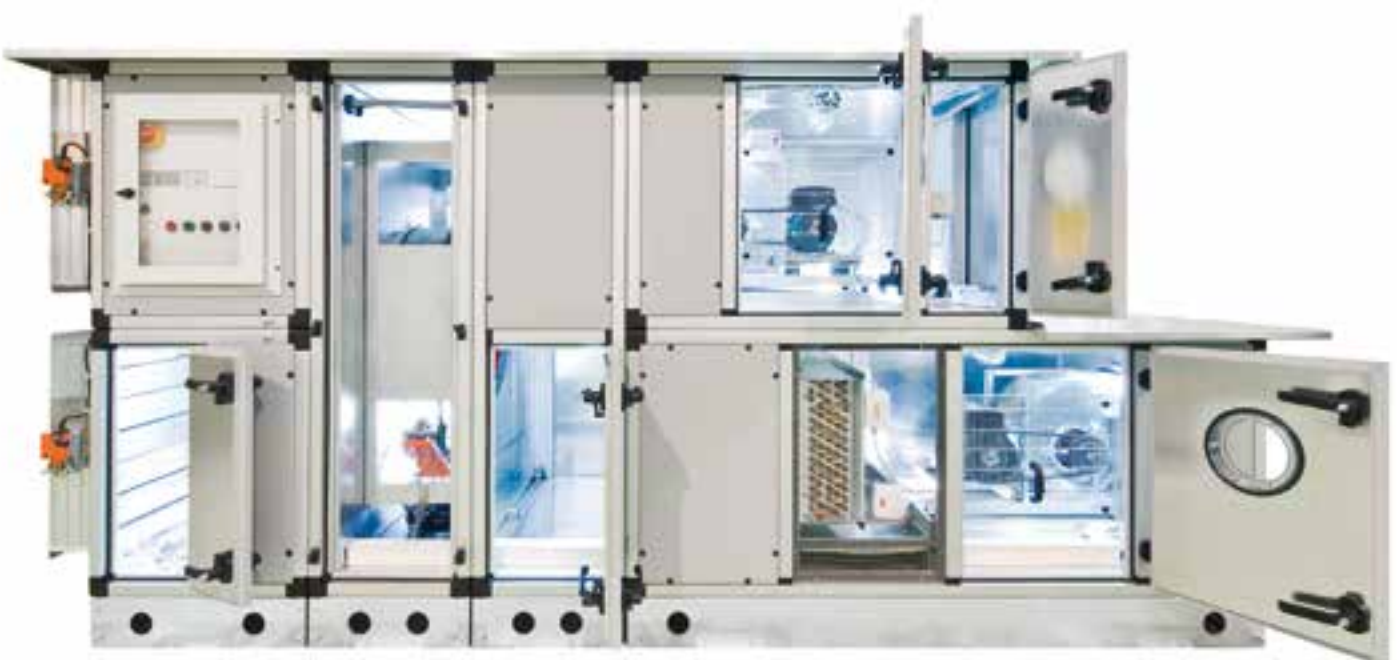

Air handling units







D-AHU MODULAR R  
INSTALLATION



COMFORTABLE  
INDOOR CLIMATE

# Products overview



## D-AHU Professional

Air flow (m<sup>3</sup>/h x 1,000)

140

120

100

90

80

70

60

50

40

20

0



### Professional

- › **Tailored to the individual customer**
- › Modular construction

### Modular R

- › Pre-configured sizes
- › Plug and play concept
- › EC fan technology
- › **Heat recovery wheel (sorption and sensible technology)**
- › **Compact design**



D-AHU  
Modular R

500 m<sup>3</sup>/h  
up to 25.000 m<sup>3</sup>/h

### Modular P

- › Pre-configured sizes
- › Plug and play concept
- › EC Fan technology
- › **High efficiency aluminium counter flow plate heat exchanger**
- › **Compact design**



D-AHU  
Modular P

500 m<sup>3</sup>/h  
up to 15.000 m<sup>3</sup>/h

### Modular L

- › Pre-configured sizes
- › Plug and play concept
- › EC Fan technology
- › **High efficiency aluminium counter flow plate heat exchanger**
- › **Low height unit**
- › **For false ceiling applications**



D-AHU  
Modular L

150 m<sup>3</sup>/h  
up to 3.450 m<sup>3</sup>/h

## Selection software

### ASTRA Web

- › Quick AHU selection that will save you precious time, drastically reducing selection time through the new software interface.
- › Very competitive solution available within the Wizard thanks to pre-uploaded parameters.
- › High selection quality, thanks to the intelligence embedded within the software core.

Quickly select your air handling unit by following the wizard:

- 1 Select the series: D-AHU Professional, D-AHU Modular R, D-AHU Modular P and Modular L
- 2 Insert the air flow supply and return
- 3 Insert the summer/winter air supply setpoint
- 4 Insert the summer/winter outdoor and extract temperature

You will get immediately your 3D result and it's ready to customize!

Now, you will be able to modify your unit (adding or changing components) in order to have a product that meets all your needs.

When finished a technical report, price list, fan curve chart and psychrometric chart can be generated. These final reports can be downloaded in different formats.

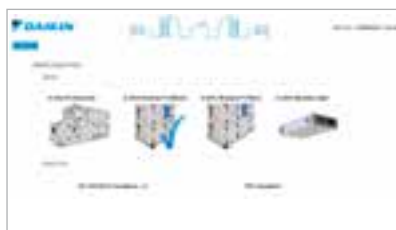

## Eurovent certification

Daikin Applied Europe S.p.A. participates in the Eurovent Certified Performance programme for Air Handling Units.

Check ongoing validity of certificate:  
[www.eurovent-certification.com](http://www.eurovent-certification.com)  
 or [www.certiflash.com](http://www.certiflash.com)



Energy Termic° S2		Eurovent Classification according to EN1886				
<b>D1</b>	Casing strength class	D1	D2	D3		
	Max. relative deflection mm x m <sup>-1</sup>	4,00	10,00	EXCEEDING10		
<b>L1</b>	Casing air leakage class at -400 Pa	L1	L2	L3		
	Max. leakage rate (f <sub>400</sub> ) l x s <sup>-1</sup> x m <sup>-2</sup>	0,15	0,44	1,32		
<b>L1</b>	Casing air leakage class	L1	L2	L3		
	Max. leakage rate (f <sub>700</sub> ) l x s <sup>-1</sup> x m <sup>-2</sup>	0,22	0,63	1,90		
<b>F9</b>	Filter bypass leakage class	F9	F8	F7	F6	G1 TO F5
	Max. filter bypass leakage rate k in % of the volume flow rate	0,50	1	2	4	6
<b>T2</b>	Thermal transmittance	T1	T2	T3	T4	T5
	(U) W/m <sup>2</sup> x K	U <= 0,5	0,5 < U <= 1	1 < U <= 1,4	1,4 < U <= 2	No requirements
<b>TB2</b>	Thermal bridging factor	TB1	TB2	TB3	TB4	TB5
	(kb) W x m <sup>-2</sup> x K-1	0,75 < K <sub>b</sub> <= 1	0,6 < K <sub>b</sub> <= 0,75	0,45 < K <sub>b</sub> <= 0,6	0,3 < K <sub>b</sub> <= 0,45	No requirements

# The working principle at a glance

Typical configurations for Daikin air handling units provide a versatile range of functions. Our system offers numerous options for customisation through an extensive range of variations and added functionality.

## Supply side

- 1 Damper section including ventilation grilles, factory-mounted actuators
- 2 Bag filter with factory-mounted differential pressure switch and hinged door
- 3 Heat recovery system (plate heat exchanger or rotative heat exchanger)
- 4 Mixing box with damper and factory-mounted actuators
- 5 Section with R-410A direct expansion coil with integrated Daikin expansion valve and drain pan
- 6 Supply air fan (with hinged door, opening, drive monitoring, mounted and cabled lighting and ON/OFF switch)

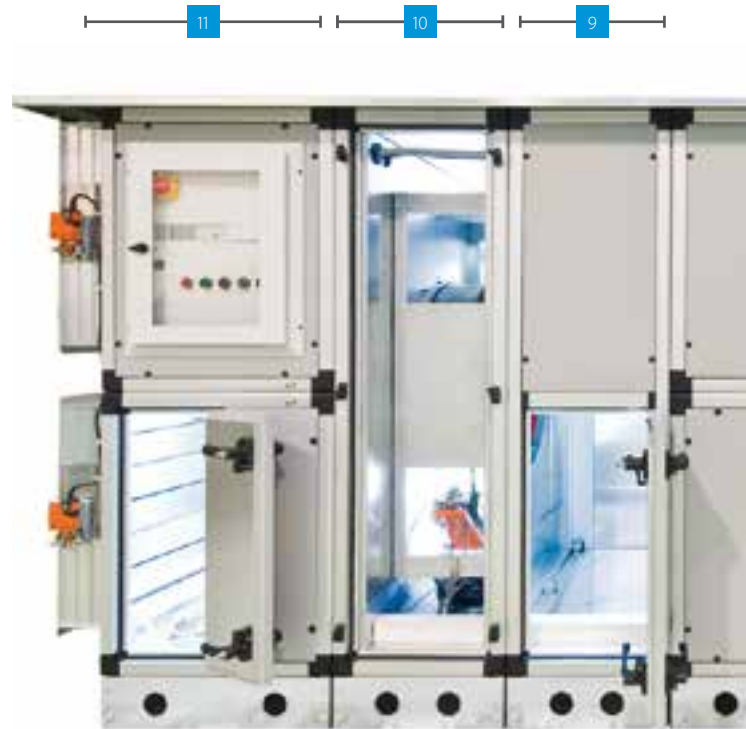
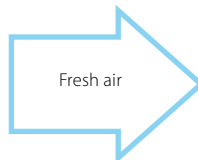
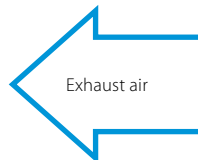

### Fans

- › EC plug fan
- › Forward curved fan
- › Backward curved fan
- › Backward airfoil blades fan
- › Plug fan

### Exchangers

- › Water coils
- › Steam coils
- › Direct expansion coil
- › Superheated water coils
- › Electric coils

### Humidifiers

- › Evaporative humidifier without pump (loss water)
- › Evaporative humidifier with re-circulating pump
- › Air washer without pump (loss water)
- › Air washer with re-circulating pump
- › Steam humidifier with direct steam production
- › Steam humidifier with local distributor
- › Atomized water spray humidifier

**Control system on plug and play solution basis**

- › Air temperature control
- › Chilled water and DX cooling system control
- › Free cooling
- › CO<sub>2</sub> automatic control

**Unique section to section thermal break profile**

- › Thermal bridge free for the entire AHU
- › Smooth interior surface with improved IAQ (Indoor Air Quality)

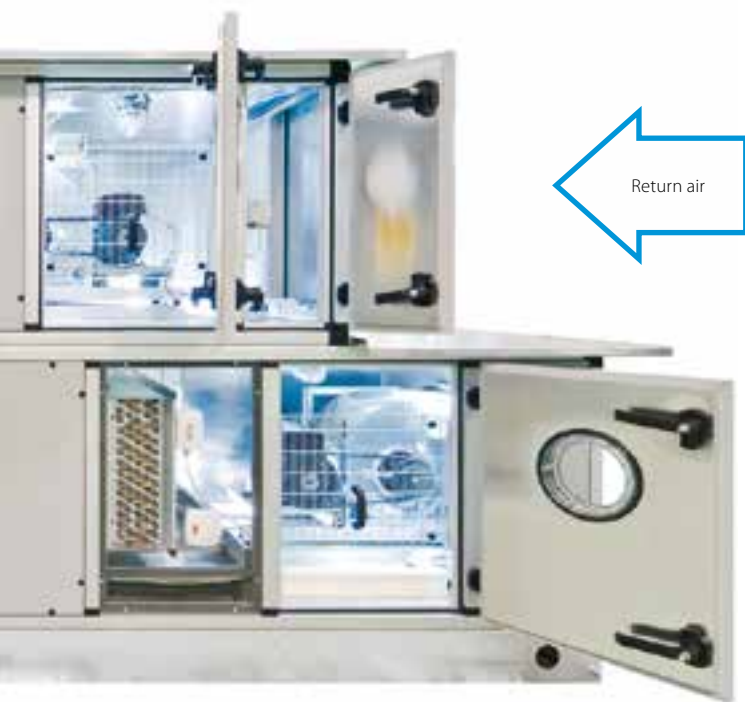
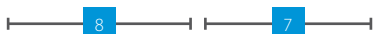
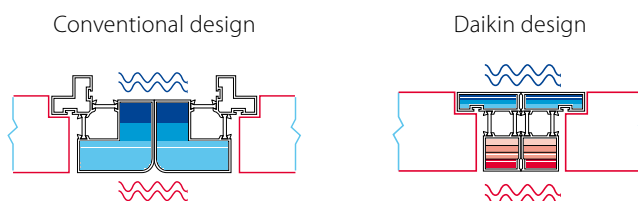

**Return side**

- 7** Bag filter with factory-mounted differential pressure manometer and hinged door.
- 8** Exhaust air fan (with hinged door, opening, drive monitoring, mounted and cabled lighting and ON/OFF switch)
- 9** Mixing box with damper and factory-mounted actuators
- 10** Heat recovery system (plate heat exchanger or rotation exchanger)
- 11** Damper section including ventilation grilles, factory-mounted actuators



**Heat recovery systems**

- › Heat wheel, sensible or sorption
- › Plate heat exchanger (optional bypass)
- › Run-around coils

**Other section**

- › Attenuator section
- › Mixing box section with actuators or manual controlled dampers
- › Empty section

**Filters**

- › Synthetic pleated filter
- › Flat filter aluminium mesh
- › Rigid bag filter
- › Soft bag filter
- › High efficiency filter
- › Carbon absorption filter
- › Carbon deodorizing filter

**Accessories**

- › Control features
- › Frost protection
- › Manometers
- › Drive guard
- › Roof
- › ...

# Professional

Flexible solution for custom applications

## Flexible design

Daikin Professional air handlers are tailored to your needs, optimizing always the unit for the most cost-effective selection and manufacturing standardization.

- › Air flow from 500 m<sup>3</sup>/h up to 144.000 m<sup>3</sup>/h.
- › All the units can be modularly designed to facilitate the transport and the assembly on site.
- › Controls: Optional Daikin Plug & Play solution



## D-AHU Professional series highlights

- › The most flexible AHU available on the market directly from Selection Software
- › All Heat recovery systems selectable
- › Outdoor or Indoor installation
- › Panel Insulation: Mineral wool and Polyurethane
- › Panel Thickness: 42mm or 62mm
- › Anodized Aluminum and Thermal break Profile optional
- › Aluzinc, Aluminum, Preprinted, AISI 304, AISI 316L
- › Several thickness of external metal sheet from 0,7 up to 1,5mm



## Plug and play: More control, more flexibility

The plug and play control system allows for more precise control than ever before, allowing the user to determine a wide range of settings, resulting in excellent operational flexibility.

The factory-fitted electrical control panel, complete with Direct Digital Control (DDC) is combined with in-built temperature, humidity and CO<sub>2</sub> sensors to control mixing dampers, heat recovery wheels, water valves, pressure switches

for filters and fans, fan motors and inverters.

All these components are wired internally and individual AHU modules are linked by fast connectors. The AHU control system can manage the chilled water coil, hot water coil, DX cooling and/or heating coil(s) (in conjunction with ERQ/VRV) of single or multiple refrigerant circuits (up to a maximum of four circuits per DX coil).

# Modular R

High-end solution with heat recovery

## Energy efficiency and indoor air quality

- › Predefined sizes
- › IE4 premium efficiency motor
- › High efficiency heat wheel (heat recovery)
- › Compact design
- › Advanced control features
- › Easy installation
- › Indoor air quality compliant with VDI 6022 hygiene guideline
- › Operating limits from -25 °C, -40 °C with electric heaters, up to +46 °C ambient temperature
- › VRV IV and ERQ coupling capability
- › Indoor and outdoor versions
- › Free cooling capability
- › Economy and Night mode operation
- › Monitoring and control through Daikin ITM



## Construction main benefits

- › Eurovent certified performances
- › No cross contamination and low internal leakage
- › Best class in corrosion resistance
- › Polyurethane foam or Mineral wool selectable as insulation materials



D-AHU Modular R		1	2	3	4	5	6	7	8	9	10
Airflow	m <sup>3</sup> /h	1.200	1.700	2.700	4.100	5.500	6.100	7.000	9.100	11.500	15.000
Temp. efficiency winter	%	82,4	82,4	82,4	82,6	82,2	82,4	83	82,6	82,5	82,7
External static pressure	Nom. Pa	200	200	200	200	200	200	200	200	200	200
Current	Nom. A	2,38	3,18	1,65	2,58	3,35	3,86	4,32	5,36	7,15	9,50
Power input	Nom. kW	0,55	0,73	1,14	1,79	2,32	2,68	2,99	3,72	4,95	6,58
SFPv	kW/m <sup>3</sup> /s	1,64	1,55	1,52	1,57	1,52	1,58	1,54	1,47	1,55	1,58
Electrical supply	Phase	1	1	3 + N	3 + N	3 + N	3 + N	3 + N	3 + N	3 + N	3 + N
	Frequency	Hz	50	50	50	50	50	50	50	50	50
	Voltage	V	230	230	400	400	400	400	400	400	400
Dimensions unit	Width	mm	720	720	990	1.200	1.400	1.400	1.600	1.940	2.300
	Height	mm	1.320	1.320	1.540	1.740	1.740	1.920	1.920	2.180	2.570
	Length	mm	1.700	1.700	1.800	1.920	2.080	2.280	2.400	2.450	2.280
Weight unit	kg	325	350	475	575	750	790	950	1.330	1.410	1.750

# Modular P

AHU with plate heat exchanger

## Highlights

- › 10 Predefined sizes
- › Compliant with VDI 6022
- › Operating limits from -25 C, -40C with electric heaters
- › Plug & Play Controls
- › Monitoring and control through Daikin ITM
- › Easy installation and commissioning



## Construction main benefits

- › Eurovent certified performances
- › No cross contamination and low internal leakage
- › Best class in corrosion resistance
- › Polyurethane foam or Mineral wool selectable as insulation materials



D-AHU Modular P			1	2	3	4	5	6	7	8	9	10
Airflow	m³/h		1.100	1.600	2.400	3.100	3.700	4.750	5.500	8.000	10.400	12.500
Thermal efficiency	%		93,9	93,6	93,2	93,1	93,1	93,1	93,1	93,3	93,1	93,1
External static pressure	Nom. Pa		200	200	200	200	200	200	200	200	200	200
Current	Nom. A		1,75	2,51	1,28	1,67	2,09	2,69	3,04	4,14	5,88	6,97
Power input	Nom. kW		0,40	0,58	0,89	1,15	1,45	1,86	2,11	2,87	4,07	4,83
SFPv	kW/m³/s		1,32	1,30	1,33	1,34	1,41	1,41	1,38	1,29	1,41	1,39
Electrical supply	Phase	ph	1	1	3 + N	3 + N	3 + N	3 + N	3 + N	3 + N	3 + N	3 + N
	Frequency	Hz	50	50	50	50	50	50	50	50	50	50
	Voltage	V	230	230	400	400	400	400	400	400	400	400
Dimensions unit	Width	mm	720	820	990	1.200	1.400	1.400	1.600	1.940	1.940	2.300
	Height	mm	1.320	1.320	1.540	1.740	1.740	1.920	1.920	2.180	2.460	2.570
	Length	mm	2.030	2.200	2.610	2.660	2.800	3.210	3.340	3.840	4.060	4.190
Weight unit	kg		343	358	512	604	785	852	964	1.449	1.700	2.071



# Modular L

Premium efficiency heat recovery unit

## Highlights

- › 6 Predefined sizes
- › Compact footprint (first unit height 280mm only)
- › First in the market for Indoor Air Quality (IAQ)
- › Premium quality counter flow plate heat exchanger with integrated bypass
- › Up to 94% of thermal energy recovered
- › Available in a left or right version
- › 50mm of mineral wool insulation (M0 fire class)
- › High grade aluminum allowing high grade corrosion protection
- › Intelligent defrost logic to decrease energy consumption and increase comfort



## Construction main benefits

- › No cross contamination and low internal leakage
- › Best class in corrosion resistance
- › 50mm Mineral wool insulation for silent operation



## Technical details

ALB-R/LB(S) <sup>(1)</sup>		02	03	04	05	06	07
Airflow/Airflow Smart	m <sup>3</sup> /h	300	600	1.200	1.500	2.500/2.300	3.000
Thermal efficiency/Thermal efficiency Smart <sup>(2)</sup>	%	93/90	93/91	93/90	92/90	94/92	93/91
External static pressure	Nom. Pa	100	100	100	100	100	100
Current/Current Smart	Nom. A	0,52	1,17	1,91	2,48	4,39/3,76	5,39
Power input/Power input Smart	Nom. kW	0,12	0,27	0,44	0,57	1,01/0,87	1,24
SFPv/SFPv Smart <sup>(3)</sup>	kW/m <sup>3</sup> /s	1,24	1,49	1,25/1,28	1,31/1,32	1,42/1,32	1,46
Electrical supply	Phase	ph	1	1	1	1	1
	Frequency	Hz	50/60	50/60	50/60	50/60	50/60
	Voltage	V	220/240 Vac	220/240 Vac	220/240 Vac	220/240 Vac	220/240 Vac
	Dimensions unit	Width	mm	920	1.100	1.600	1.600
	Height	mm	280	350	415	415	500
	Length	mm	1.660	1.800	2.000	2.000	2.000
Weight unit	kg	125	180	270	280	355	360
Rectangular duct flange	Width	mm	250	400	500	500	700
	Height	mm	150	200	300	300	400
Unit sound power level/Unit sound power level Smart	dBA	48	54	57	53	62/60	57
Unit sound pressure level/Unit sound pressure level Smart <sup>(4)</sup>	dBA	34	39	41	37	46	41

Notes: (1) R= right connection and L= left connection; S = Smart Solution (Daikin PCB) (2) Winter design condition: Outdoor: -10°C (-5°C for Modular Light Smart), 90% Indoor: 22°C,50%; (3) SFPv is a parameter that quantifies the fan efficiency (the lower it is the better will be). This reduces if airflow decreases.; (4) EN 3744. Surrounding, Directivity (Q) = 2, @1,5m distance. For any performances out of the nominal condition here above mentioned kindly refer to the online selection available online at tools.daikinapplied.eu

# Daikin fresh air package



## Plug and play connection of AHU to Daikin VRV and ERQ

The Daikin fresh air package provides a complete solution, including all unit controls (expansion valve, control box and AHU controller) and sensors factory mounted and configured.

### Higher efficiency

Daikin heat pumps are renowned for their high energy efficiency. Integrating the AHU with a heat recovery system is even more effective since an office system can frequently be in cooling mode while the outdoor air is too cold to be brought inside in an unconditioned state. In this case heat from the offices is merely transferred to heat up the cold incoming fresh air.

### High comfort levels

Daikin ERQ and VRV units respond rapidly to fluctuations in supply air temperature, resulting in a steady indoor temperature and resulting in high comfort levels for the end user. The ultimate is the VRV range which improves comfort even more by offering continuous heating, also during defrost.

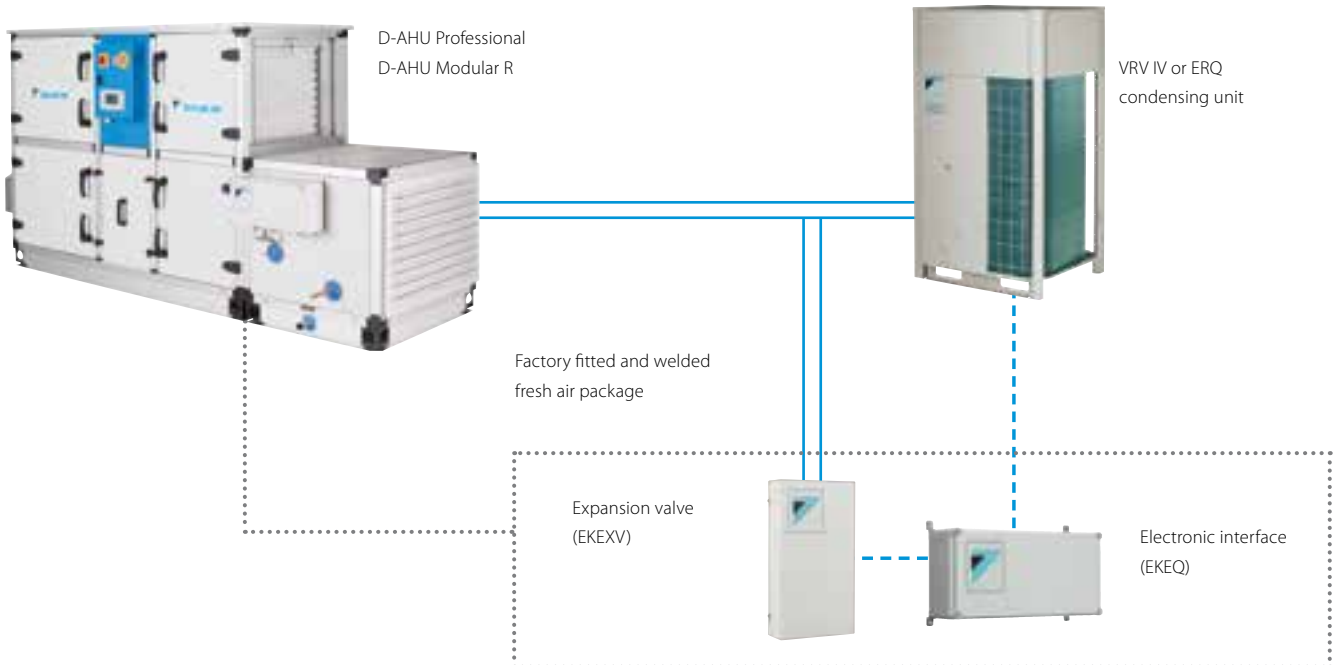

# Customised regulation and control systems

## All Modular air handling systems come with a regulation and control system (with or without connection to a BMS).

The MicroTech III controller is designed to work with most applications. It can thus manage a chilled water system or di-

rect-expansion system while providing management of the heat recovery loop for constant or variable speeds.

This allows for precise temperature control based on P.I.D. regulation, and constantly optimises the operating parameters of the air handling unit.

- › LCD display with 164 x 44 pixels.
- › 3-key control panel.
- › Rotating knob control for greater ease of use.
- › Memory for data backups.
- › Alarm relays for general types of incidents.
- › Password-controlled access for configuration changes.
- › Maintenance reports showing all run-time hours and general operating conditions.
- › Alarm log to facilitate the analysis of incidents.

The MicroTech III controller provides the option of controlling the set-points for ambient air temperature, air return and supply air, and the possibility of regulating air quality with the addition of a CO<sub>2</sub> probe. For additional information about these features, please contact your Daikin representative.



The POL638 standard software has been customised to manage the control signals of Daikin's ERQ and VRV IV systems.

# Table of content

# Control Systems

Mini building management system	
intelligent touch Manager	190
<b>NEW</b> intelligent chiller Manager	194
Standard protocol interfaces	
Modbus interface	197
<b>BACnet Interface</b>	200
<b>LonWorks Interface</b>	201
Centralised control systems	
<b>NEW</b> Daikin on Site	202

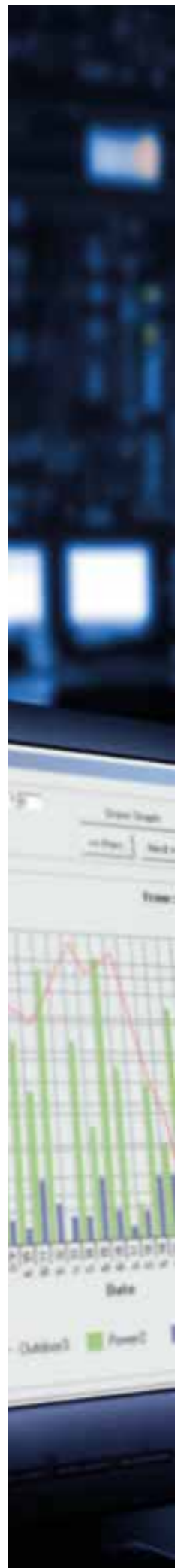



# Mini BMS

with full integration  
across all product pillars

DCM601A51

**Intelligent Manager**

- Price competitive mini BMS
- Cross-pillar integration of Daikin products
- Integration of third party equipment



**NEW**

Download the WAGO  
selection tool from  
[my.daikin.eu](http://my.daikin.eu)

- › Easy selection of WAGO materials
- › Material list creation
- › Time saving
  - Includes wiring schemes
  - Contains commissioning/preset data for iTM



Check on  
**YouTube**

[www.youtube.com/DaikinEurope](http://www.youtube.com/DaikinEurope)

# System overview

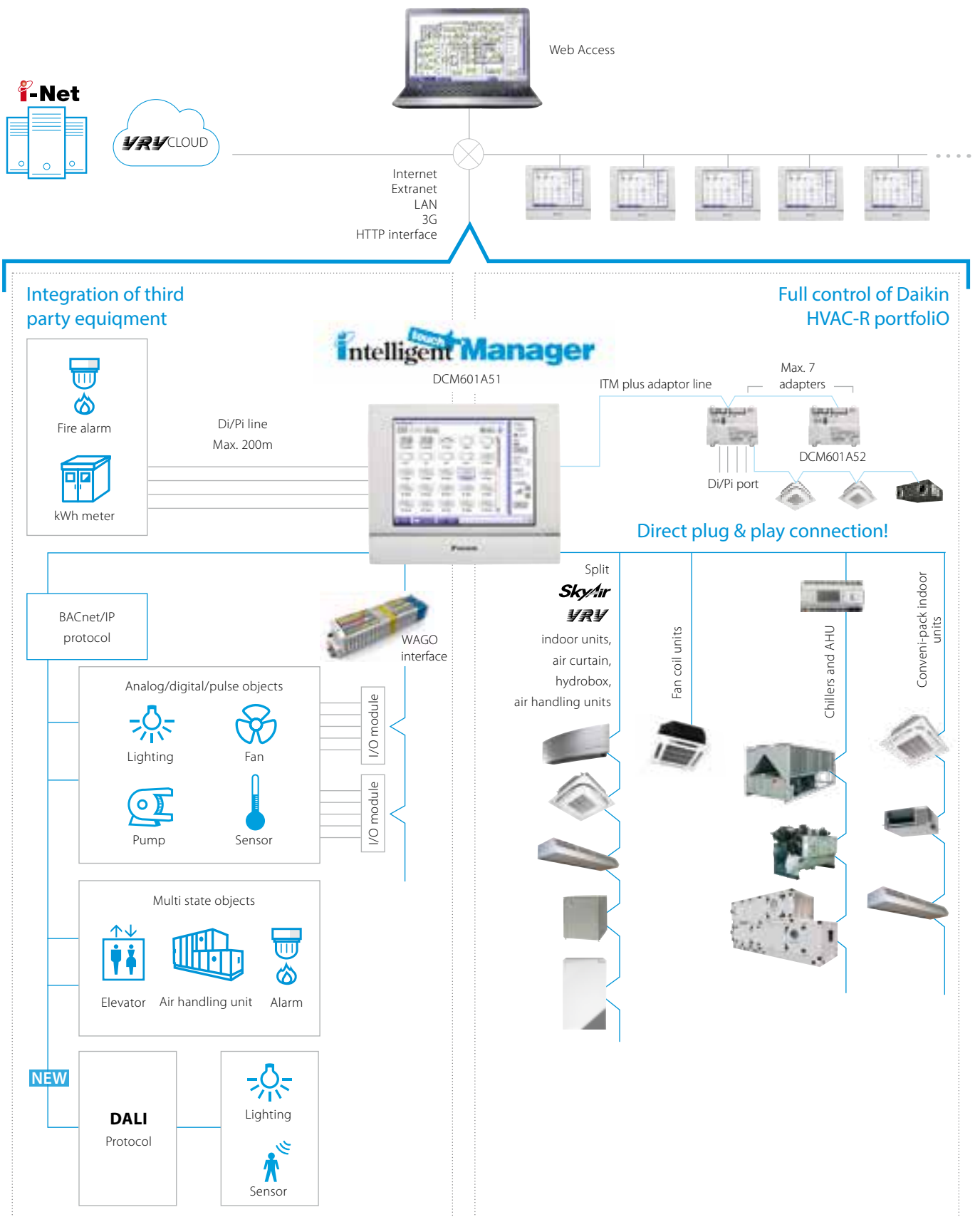

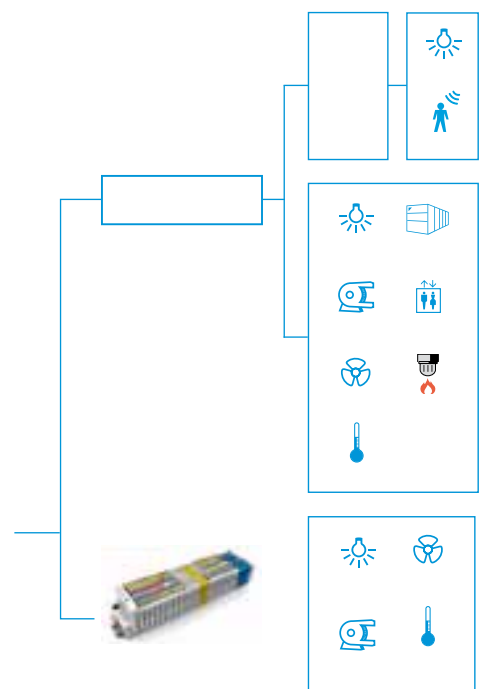
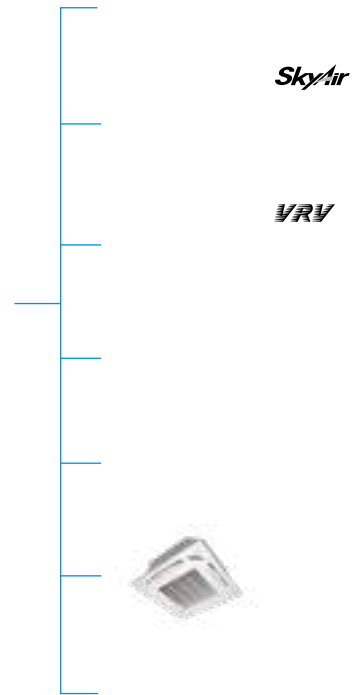







## Factory-engineered system control to manage a chiller plant room

Thus optimising its performance and increasing its reliability by:

- › Optimal start-up, sequencing & staging of chillers
- › Matching chiller capacity to load demand

### iCM's main functionalities:

#### Availability

Determines whether chillers are available or not, based on:

- › Inputs from the chiller unit controllers
- › Modbus communication status
- › Pump status

#### Sequencing

Optimises the order in which available chillers are turned on and off depending on operating hours, energy efficiency, etc.

#### Staging

Calculates **energy-optimal stage-up/stage-down** of the chiller by determining the increased capacity demand by capacity control, compensation of temperature and rotation. This function aims at providing the most energy-efficient combination of chillers on a continuous basis.

#### Stopping Last Chiller/Recycling

Captures a rise in demand when the **last chiller is staged down**, by operating the pump dedicated to the next ON chiller at a minimum VFD frequency.

#### Min/Max Operating Chiller Setting

Ensures that the number of operating chillers always **stays within a certain range**, regardless of changes in demand.

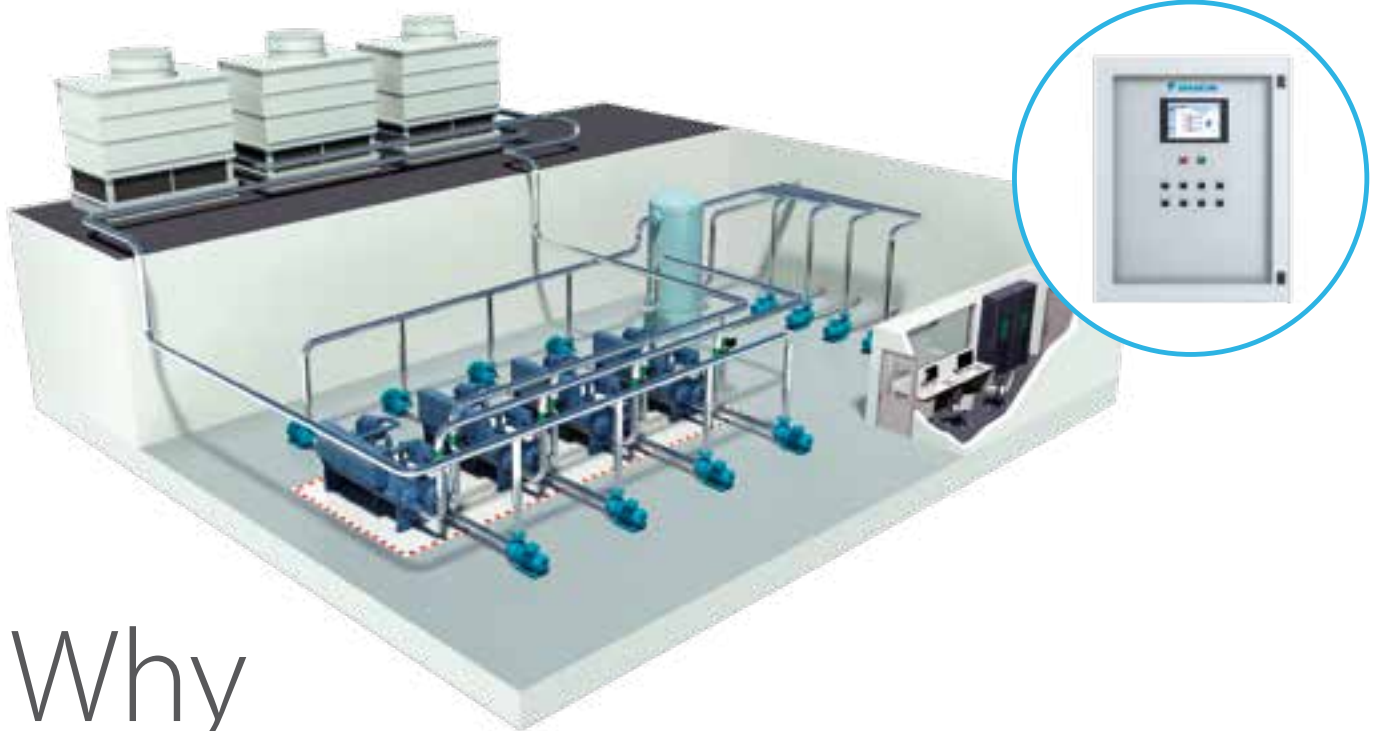

## Why choose iCM?

- › Optimise performance
- › Increase reliability
- › Reduce energy costs
- › Reduce maintenance costs
- › Factory-engineered and tested
- › Remote control and monitoring. From one-time commissioning to real-time commissioning

**Daikin is the best qualified partner to optimise the operation of a Daikin chiller plant room.**

**NEW** iCM is available in two versions:

**Standard**



(Configuration )



(Basic)  
(≤4 MT3 chillers)



(Light/Full)  
(≤4/≤8 MT3 chillers  
& peripherals)

**Standard version**

Configurable controller with a pre-set library of applications. The standard system is divided into three configurations according to how many chillers and peripherals it can manage.

**Customised**



(Free-programmable )



(Customised )

**Customised version**

Free-programmable controller for those applications not covered by the Standard version.

**ICMPAF**

**ICMPAL**

**ICMPAB**

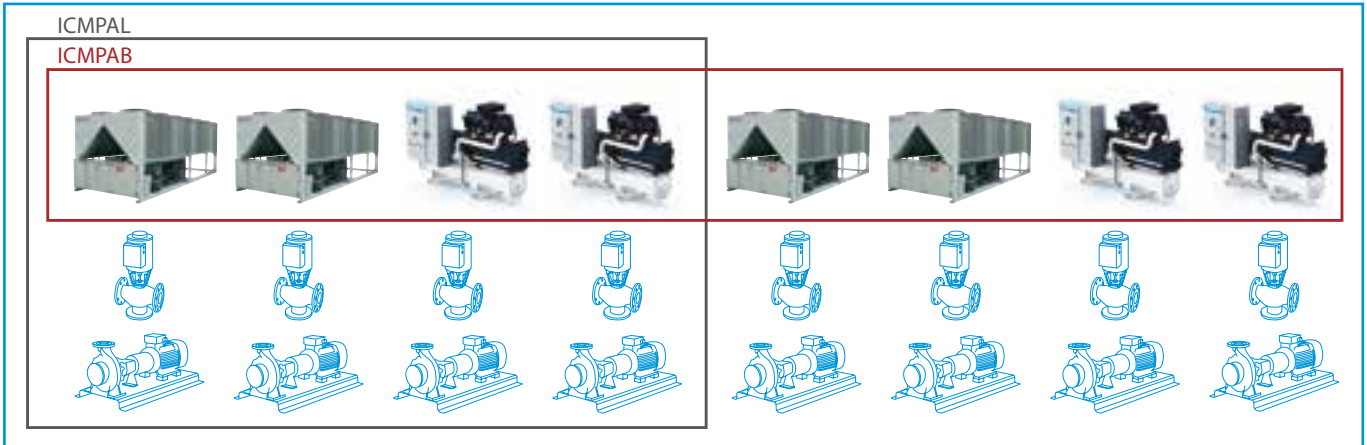

**intelligent Chiller Manager**

<b>iCM Basic</b> <sup>®</sup> , for evaporator side management up to 8 chiller manageable (without peripheral device)	<b>EKDICMPAB</b>
<b>iCM Light</b> <sup>®</sup> , for evaporator side management up to 8 chiller, up to 4 evaporator pumps, up to 4 evaporator shut-off valves, 1 bypass valve (evaporator side) manageable	<b>EKDICMPAL</b>
<b>iCM Full</b> <sup>®</sup> , for evaporator side management up to 8 chiller, up to 8 evaporator pumps, up to 8 evaporator shut-off valves, 1 bypass valve (evaporator side) manageable	<b>EKDICMPAF</b>
<b>iCM Customised</b> based on ad hoc specifications	

**iCMPWF**

**iCMPWL**

**ICMPAB**

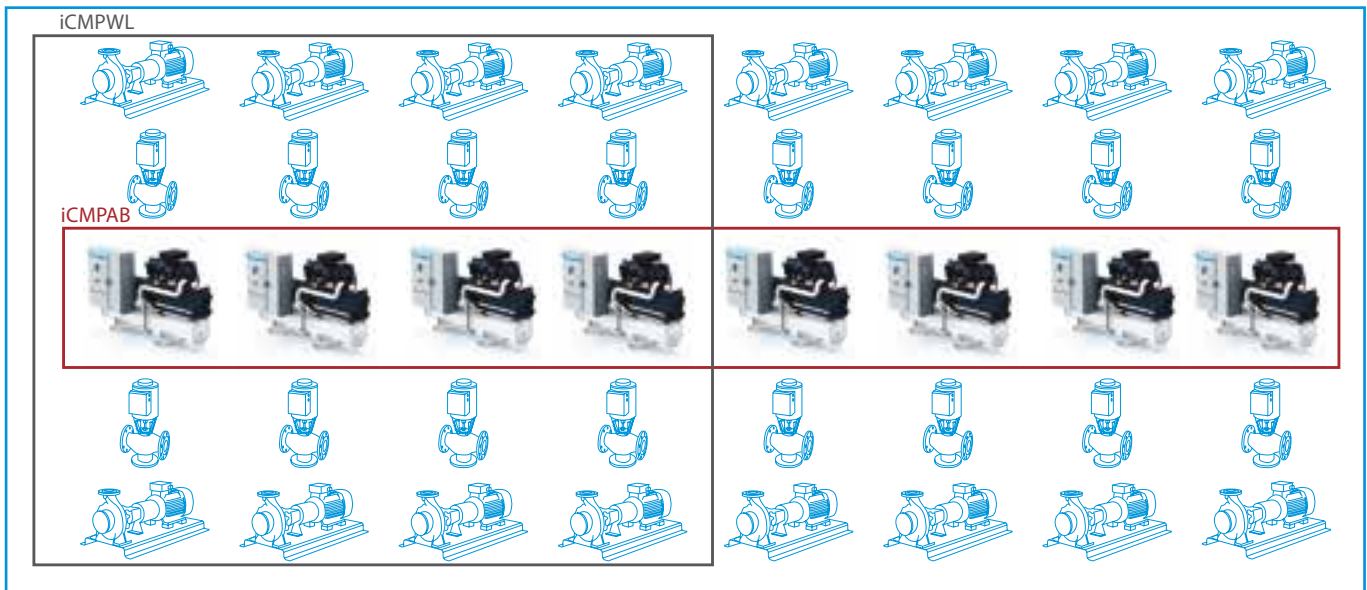

**intelligent Chiller Manager**

<b>iCM Light</b> , for evaporator and condenser side management up to 8 chillers, up to 4 evaporator pumps and 4 condenser pumps, up to 4 evaporator and 4 condenser shut-off valves, 1 bypass valve (evaporator side), 1 bypass valve (condenser side) manageable	<b>EKDICMPWL</b>
<b>iCM Full</b> , for evaporator and condenser side management up to 8 chillers, up to 8 evaporator pumps and 8 condenser pumps, up to 8 evaporator and 8 condenser shut-off valves, 1 bypass valve (evaporator side), 1 bypass valve (condenser side) manageable	<b>EKDICMPWF</b>

# intelligent Chiller Manager - iCM

iCMPAL-IO (Light)

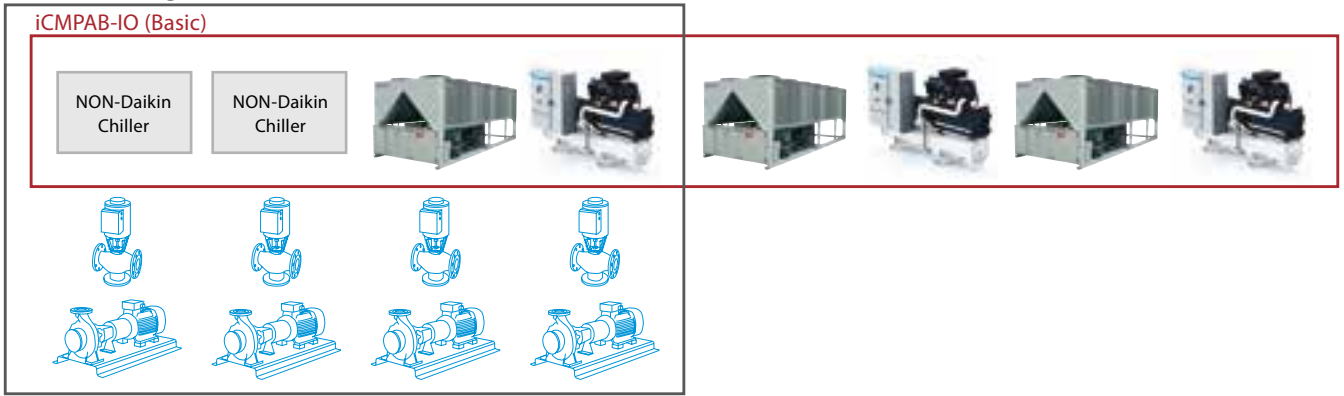

intelligent Chiller Manager		
<b>ICM Basic</b> , for evaporator side management of Daikin and Non-Daikin Chiller up to 8 chillers (up to 2 non-Daikin) manageable		<b>EKDICMPAB-IO</b>
<b>ICM Light</b> , for evaporator side management of Daikin and Non-Daikin Chiller up to 8 chillers (up to 2 non-Daikin), up to 4 evaporator pumps, up to 4 evaporator shut-off valves, 1 bypass valve (evaporator side) manageable		<b>EKDICMPAL-IO</b>

ICMCTF

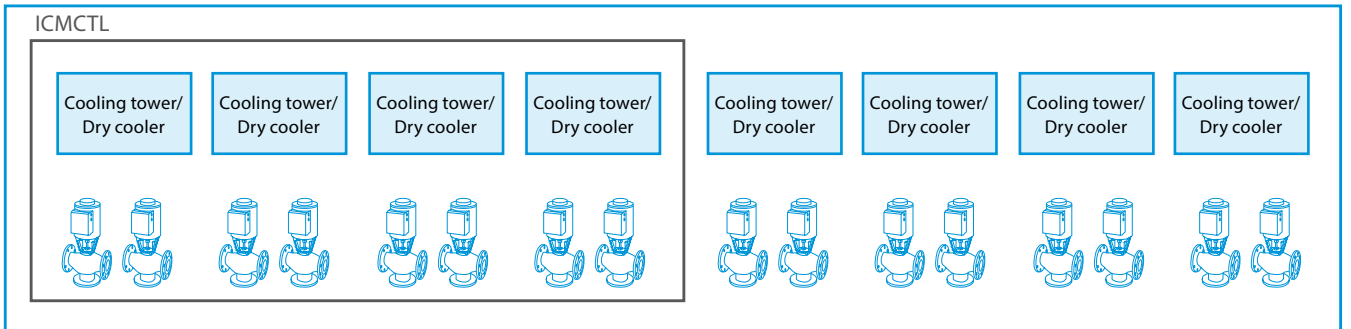

intelligent Chiller Manager		
<b>ICM Light</b> , for Cooling tower/Dry Cooler management up to 4 Cooling tower/Dry Cooler, up to 4 fan, up to 4 sump valves, up to 4 spray valves manageable		<b>EKDICMCTL</b>
<b>ICM Full</b> , for Cooling tower/Dry Cooler management up to 4 groups of Cooling tower/Dry Cooler, up to 8 fan, up to 8 sump valves, up to 8 spray valves manageable		<b>EKDICMCTF</b>

## Scope and type of equipment which can be controlled by iCM

	Specification
<b>Chiller (Dedicated/Manifolded)</b>	≤8
<b>Operating mode</b>	Cooling
<b>Evaporator pumps (CSD/VFD) &amp; (Dedicated/Manifolded)</b>	≤8
<b>Shut-off valves (evaporator side)</b>	≤8
<b>Bypass valve (evaporator side)</b>	✓
<b>Condenser pumps (CSD/VFD) &amp; (Dedicated/Manifolded)</b>	≤8
<b>Shut-off valves (condenser side)</b>	≤8
<b>Bypass valve (condenser side)</b>	✓
<b>Cooling tower/Dry cooler fans (CSD/VFD)</b>	≤(8x3)

## Remote control and monitoring possibilities

(valid for both Standard and Customised versions)

- Connectivity to Daikin's remote monitoring and control system ([www.daikinon-site.com](http://www.daikinon-site.com))**  
 for remote monitoring and service providing Internet connection to the main controller
- Integration with general BAS/BMS** offered through BACnet or Modbus Modules based on BACnet/IP or Modbus RTU/RS-485 protocols
- Built-in HMI, Remote HMI, Web HMI and [daikinon-site.com](http://daikinon-site.com)** are available for control and configuration

Notes:

(1)The iCM option is compatible for the following chiller series: EWHA~TZB, EWAD~TZB, EWAD~T- (B), EWAQ~G-, EWAQ~E (single), EWAQ~F (dual), EWAT\_B (single), EWAT\_B (dual), EWAD~CZ, EWAD~CF, EW\_Q-G, EW\_Q-L, EWWD~G-, EWLD~G-, EWLD~I-, EWWD~J-, EWLD~J-, EWWH~VZ A, EWWD~VZ A, EWWH~DZ, EWWD~DZ, DWSC & DWDC, WTC. Daikin chiller not in this list and non-Daikin (3rd party) chillers, can be managed by EKDICMPAB/L-IO.

# Modbus Interface

## RTD-W

Modbus interface for monitoring and control of Daikin Altherma Flex Type, VRV HT hydrobox and **small inverter chiller**.



Main functions		RTD-W
Dimensions	H x W x D mm	100x100x22
On/off prohibition		R
Modbus RS485		R
Dry contact control		R
Output signal (operation error)		R
Space heating / cooling operation		R
Domestic hot water control		R
Smart Grid control		
Control functions		
On/Off Space heating/cooling		M,C
Set point leaving water temperature (heating / cooling)		M,V
Room temperature setpoint		M
Operation mode		M
Domestic Hot water ON		
Domestic Hot Water reheat		M,C
Domestic Hot Water reheat setpoint		
Domestic Hot Water storage		M
Domestic Hot Water Booster setpoint		
Quiet mode		M,C
Weather dependent setpoint enable		M
Weather dependent curve shift		M
Fault/pump info relay choice		
Control source prohibition		M
Smart grid mode control		
Prohibit Space heating/cooling		
Prohibit DHW		
Prohibit Electric heaters		
Prohibit All operation		
PV available for storage		
Powerful boost		
Monitoring functions		
On/Off Space heating/cooling		M,C
Set point leaving water temperature (H/C)		M
Room temperature setpoint		M
Operation mode		M
Domestic Hot Water reheat		M
Domestic Hot Water storage		M
Number of units in the group		M
Average leaving water temperature		M
Remocon room temperature		M
Fault		M,C
Fault code		M
Circulation pump operation		M
Flow rate		
Solar pump operation		
Compressor status		M
Desinfection operation		M
Setback operation		M
Defrost/ start up		M
Hot start		
Booster Heater operation		
3-Way valve status		
Pump running hours accumulated		M
Compressor running hours accumulated		
Actual leaving water temperature		M
Actual return water temperature		M
Actual DHW tank temperature (*)		M
Actual refrigerant temperature		
Actual outdoor temperature		M

M : Modbus / R : Resistance / V : Voltage / C: control  
 \* : only when room is occupied / \*\* : setpoint limitation / (\*) if available  
 \*\*\* : no fan speed control on the CYV air curtain / \*\*\*\* : run & fault

# Modbus interface

Integrate chillers, fan coil units and air handling units in BMS systems via modbus protocol

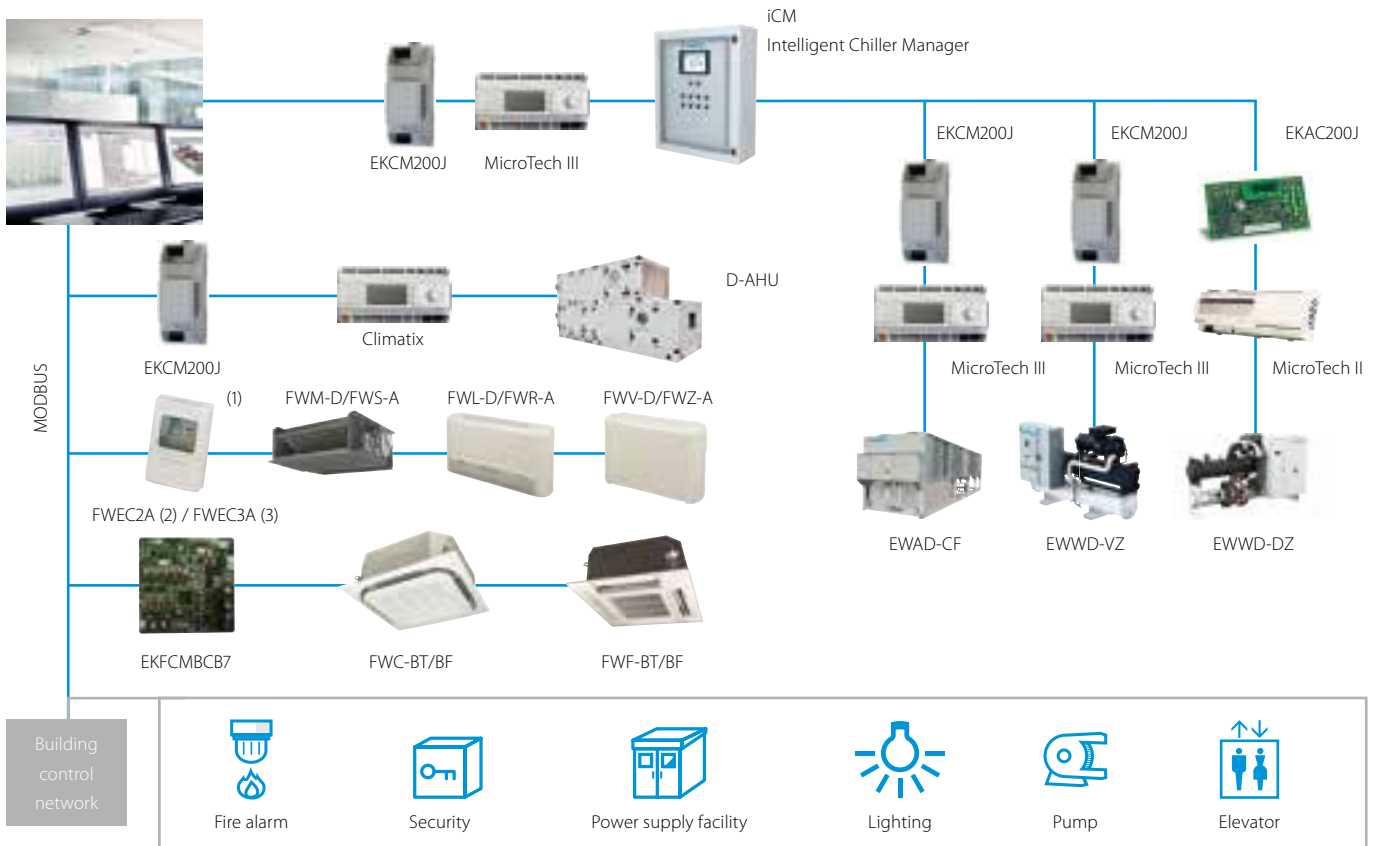

(1) The communication module is integrated in the controller (2) Connection to FWV-D, FWL-D & FWM-D (3) Connection to FWV-D, FWL-D, FWM-D and to FWZ-A, FWR-A, FWS-A

Integrate Refrigeration units in BMS systems via modbus protocol

## BRR9A1V1



\* For all connectable indoor units and Biddle air curtains please refer to the Conveni-pack pages in this catalogue

# DIII-net Modbus interface

EKMBDXA

Integrated control system for seamless connection between Split, Sky Air, VRV and small inverter chillers and BMS systems



- › Communication via Modbus RS485 protocol
- › Detailed monitoring and control of the VRV total solution
- › Easy and fast installation via DIII-net protocol
- › As the Daikin DIII-net protocol is being used, only one modbus interface is needed for a group of Daikin systems (up to 10 outdoor unit systems).

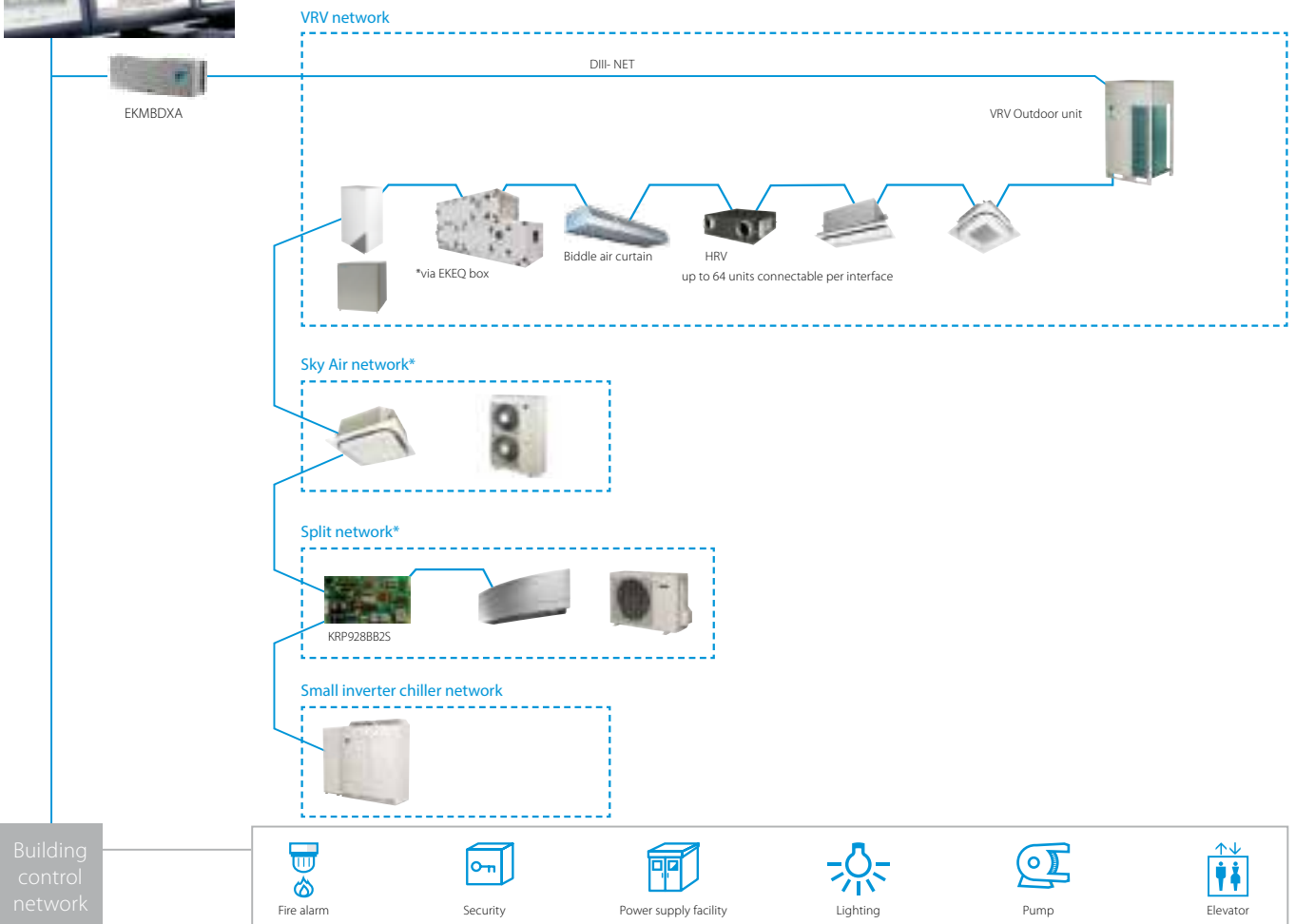

\* Additional centralized controller might be required. For more information contact your local dealer.

		<b>EKMBDXA7V1</b>		
Maximum number of connectable indoor units		64		
Maximum number of connectable outdoor units		10		
Communication	DIII-NET - Remark	DIII-NET (F1F2)		
	Protocol - Remark	2 wire; communication speed: 9600 bps or 19200 bps		
	Protocol - Type	RS485 (modbus)		
	Protocol - Max. Wiring length	m	500	
Dimensions	HeightxWidthxDepth	mm	124x379x87	
Weight		kg	2.1	
Ambient temperature - operation	Max.	°C	60	
	Min.	°C	0	
Installation			Indoor installation	
Power supply	Frequency	Hz	50	
	Voltage	V	220-240	

# BACnet Interface

DMS502A51 / EKACBACMSTP / EKCBACIP / EKCBACMSTP

Integrated control system for seamless connection between VRV, applied systems, air handling units and BMS systems

- › Interface for BMS system
- › Communication via BACnet protocol (connection via Ethernet)
- › Unlimited site size
- › Easy and fast installation
- › PPD data is available on BMS system (only for VRV)

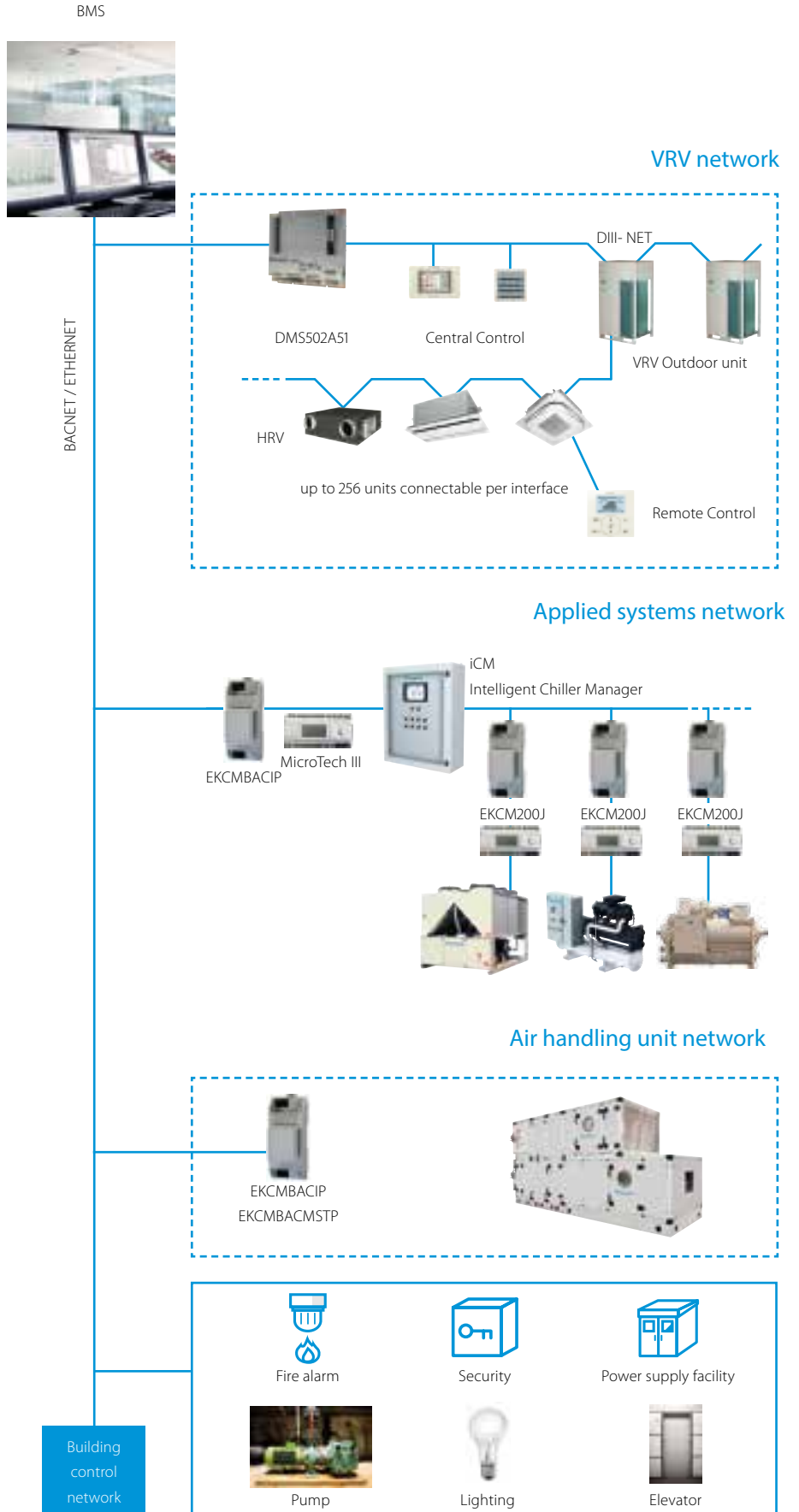



# LonWorks Interface

DMS504B51 / EKAACLONP

Open network integration of VRV and applied systems monitoring and control functions into LonWorks networks

- › Interface for Lon connection to LonWorks networks
- › Communication via Lon protocol (twisted pair wire)
- › Unlimited sitesize
- › Quick and easy installation

LON BMS

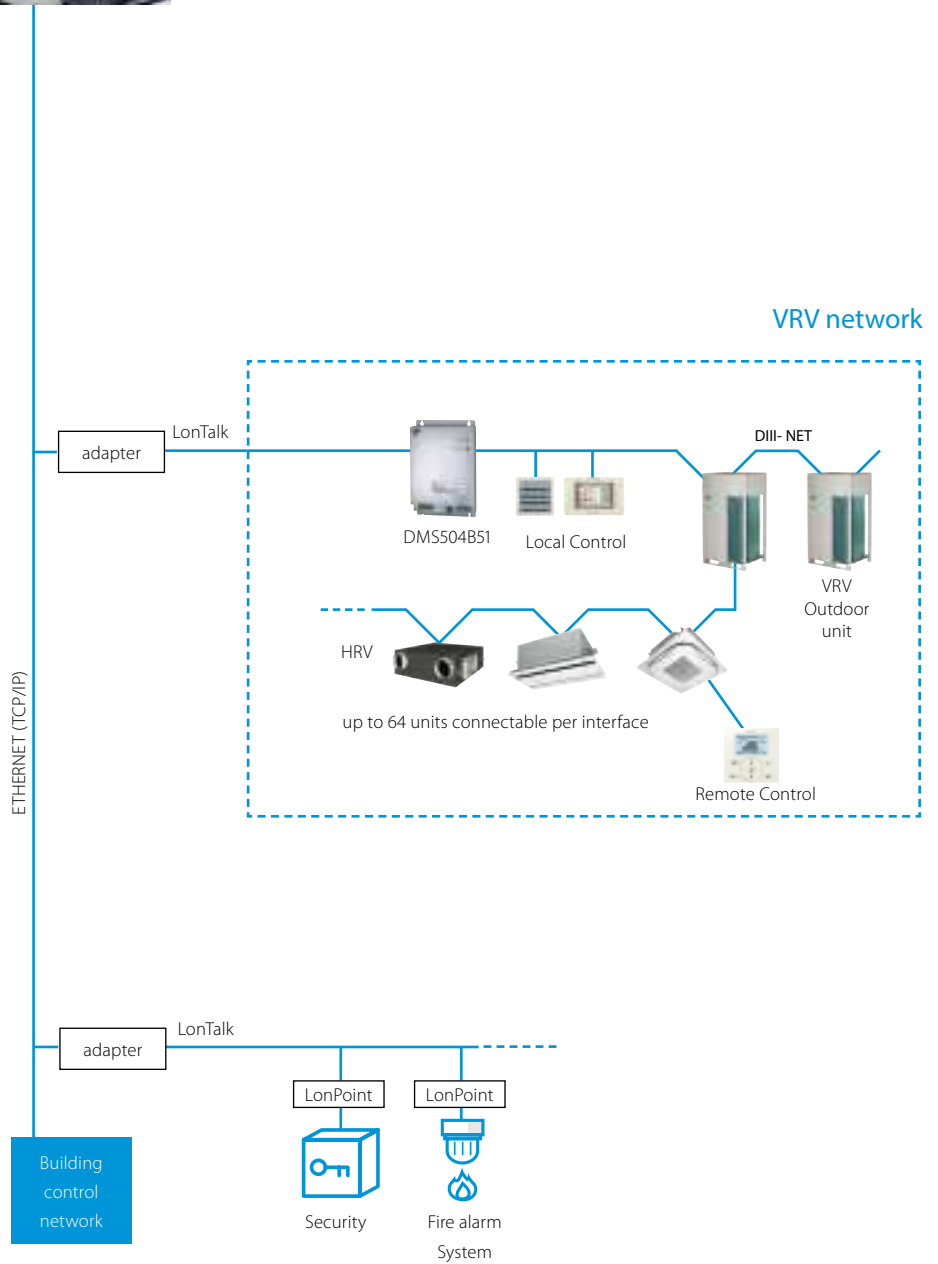



# Why Daikin on Site?

**Operating costs like energy and maintenance typically account for 85% of the system's total lifetime cost. Undiscovered energy waste and incorrect operation will increase costs and can even lead to unscheduled interruptions.**

Using Daikin on Site monitoring results in optimum use and costs over the system's entire lifetime:

- › Enhanced control and measuring
- › Monitors the system
- › Reduces risks at the earliest possible moment
- › Keeps the system running as it was intended to

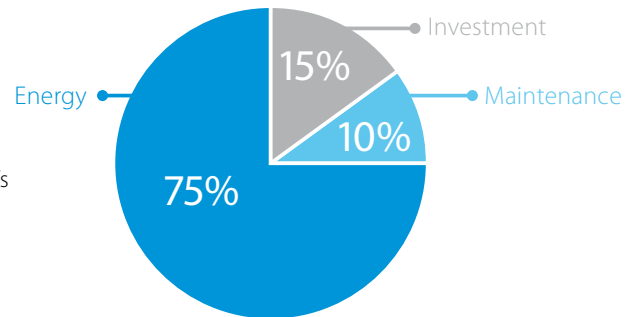

Typical Life cycle Cost of a chiller (15 years)

# What is Daikin on Site?

## A solution for customer specific needs

The Daikin on Site cloud server collects operational data from the control system of a Daikin chiller or air handling unit plant.

Daikin's Smartcentre then turns this data into useful information on a web user interface.

Daikin on Site has predefined user roles like:

- › operator
- › service provider
- › Daikin specialists

The Daikin on Site platform's features are designed to:

- › Increase uptime, reduce unscheduled interruptions
- › Optimise efficiency and reduce energy waste
- › Increase lifetime and avoid wear by misuse
- › Give insight into the optimum use of equipment, including advice from a Daikin expert

We will combine Daikin on Site remote monitoring with the complementary service programme best suited to your needs.



# How does Daikin on Site deliver?

## 1 Insight wherever and whenever required, full visibility and traceability of the HVAC installation.

- › Real-time information and trend insights
- › No local software required
- › Personal access to the web-based user interface
- › Reports

## 2 With Daikin on Site, we team up operators and specialists.

- › User-friendly operator information
- › State-of-the art tool providing best-in-class service
- › Remote solutions when possible, avoiding on site interventions

## 3 Converting all expertise to maintain highest energy efficiency and uptime.

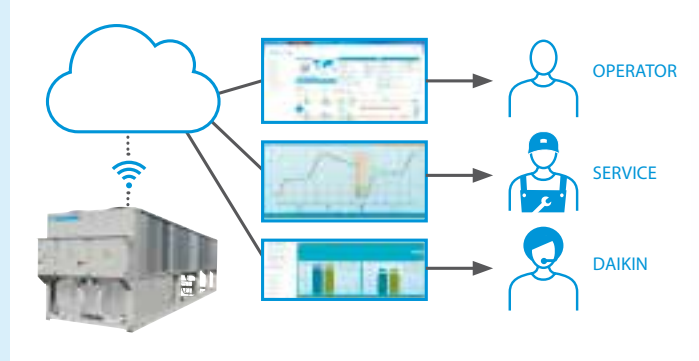

ACTION TAKEN



You can hand it to us

**Alerts & web application**

- › 24/7 year-round alarm and event monitoring
- › Automated alarm system
- › Receive service updates or notifications via email
- › Access to Daikin on Site web application

**Active monitoring**

- › Remote alarm analysis and diagnostics provided by Daikin Experts
- › Fast and reliable on site service

**Connected Service Plan**

- › Remote alarm analysis and diagnostics provided by Daikin Experts
- › Fast and reliable on site service
- › All initiatives are combined with the most suitable Daikin Service Plan

CLOUD DATA WAREHOUSE



Encrypted data transfer

**SMARTCENTRE**  
Turns data into actions



# Power supply

- T1 = 3~, 220V, 50Hz
- V1 = 1~, 220-240V, 50Hz
- VE = 1~, 220-240V/220V, 50Hz/60Hz\*
- V3 = 1~, 230V, 50Hz
- VM = 1~, 220~240V/220~230V, 50Hz/60Hz
- W1 = 3N~, 400V, 50Hz
- Y1 = 3~, 400V, 50Hz

\* For VE power supply only 1~, 220-240V, 50Hz data is displayed in this catalogue.

# Conversion table refrigerant piping

inch	mm
1/4"	6,4 mm
3/8"	9,5 mm
1/2"	12,7 mm
5/8"	15,9 mm
3/4"	19,1 mm
7/8"	22,2 mm
1 1/8"	28,5 mm
1 3/8"	34,9 mm
1 5/8"	41,3 mm
1 3/4"	44,5 mm
2"	50,8 mm
2 1/8"	54 mm
2 5/8"	66,7 mm

# F-gas regulation

For fully/partially charged equipment: contains fluorinated greenhouse gases. Actual refrigerant charge depends on the final unit construction, details can be found on the unit labels.

For non pre-charged equipment (Chillers: split chiller (SEHVX/SERHQ), condensing units and condenserless chillers + refrigeration (LCBKQ-AV1, JEHCCU/JEHSCU and ICU): its functioning relies on fluorinated greenhouse gases.

# Measuring conditions

## Air conditioning

1) Nominal cooling capacities are based on:	
Indoor temperature	27°CDB/19°CWB
Outdoor temperature	35°CDB
Refrigerant piping length	7.5m - 8/5m VRV
Level difference	0m
2) Nominal heating capacities are based on:	
Indoor temperature	20°CDB
Outdoor temperature	7°CDB/6°CWB
Refrigerant piping length	7.5m - 8/5m VRV
Level difference	0m

## Refrigeration

ZEAS	Chilling	Evaporating temp. -10°C; outdoor temp. 32°C; Suction SH10°C
	Freezing	Evaporating temp. -35°C; outdoor temp. 32°C; Suction SH10°C
Conveni-Pack	Cooling priority mode	Indoor temp. 27°CDB/19°CWB; outdoor temp. 32°CDB; piping length:7.5m; level difference: 0m Evaporating temp. -10°C; outdoor temp. 32°CDB; Suction SH: 10°C
	Heating recovery 100% mode	Indoor temp. 20°C; outdoor temp. 7°CDB,6°CWB; refrigeration load 18kW; piping length:7.5m; level difference: 0m
	Saturated temperature equivalent to suction pressure (refrigeration side)	10°C (under chilled condition); connection capacity for indoor air conditioner: 10HP, when heat recovery is 100
Booster unit		Evaporating temp. -35°C; outdoor temp. 32°C; suction SH 10K; saturated temp. to discharge pressure of booster unit -10°C
CCU/SCU		Outside ambient temp. 32°C; Evaporating temp. = -10°C and 10K superheat (medium temperature application)
Zanotti	Medium temperature	When normally running : 0°C / 30°C
	Low temperature	When normally running : -20°C / +30°C
	High temperature	When normally running : +10°C / +30°C

## Applied systems

Air cooled	Cooling only	Evaporator: 12°C/7°C	Ambient: 35°CDB
	Heat pump	Evaporator: 12°C/7°C Condenser: 40°C/45°C	Ambient: 35°C Ambient: 7°CDB/6°CWB
Water cooled	Cooling only	Evaporator: 12°C/7°C Condenser: 30°C/35°C	
	Heating only	Evaporator: 12°C/7°C Condenser: 40°C/45°C	
Condenserless chiller		Evaporator: 12°C/7°C Condensing temperature: 45°C / liquid temperature: 40°C	
Fan coil units	Cooling		Indoor temperature 27°CDB, 19°CWB; entering water temperature 7°C, water temperature rise 5K
	Heating	2-pipe	Indoor temperature 20°CDB, 15°CWB; entering water temperature 45°C, water temperature drop 5K
		4-pipe	Indoor temperature 20°CDB, 15°CWB; entering water temperature 65°C, water temperature drop 10K
Air Handling Units	Temperature and humidity conditions: Extract air 22°C / 50%; Fresh air -10°C / 90%		

The sound pressure level is measured via a microphone at a certain distance from the unit. It is a relative value, depending on the distance and acoustic environment (for measuring conditions: please refer to the technical databooks). The sound power level is an absolute value indicating the "power" which a sound source generates. For more detailed information please consult our technical databooks.



# New Daikin chiller range with inverter screw compressor and new ecological HFO R-1234ze(E) refrigerant



## High efficiency chiller for comfort and process cooling



### DAIKIN AIRCONDITIONING CENTRAL EUROPE HandelsgbH

campus 21, Europaring F12/402, A-2345 Brunn am Gebirge · Tel.: +43 / 2236 / 32557 · Fax: +43 / 2236 / 32557-910 · e-mail: office@daikin.at · www.daikin-ce.com

Daikin products are distributed by:



Daikin Europe N.V. participates in the Eurovent Certification programme for Liquid Chilling Packages (LCP), Air handling units (AHU) and Fan coil units (FCU). Check ongoing validity of certificate online: [www.eurovent-certification.com](http://www.eurovent-certification.com) or using: [www.certiflash.com](http://www.certiflash.com)

The present publication is drawn up by way of information only and does not constitute an offer binding upon Daikin Europe N.V. / Daikin Central Europe HandelsGmbH. Daikin Europe N.V. / Daikin Central Europe HandelsGmbH have compiled the content of this publication to the best of their knowledge. No express or implied warranty is given for the completeness, accuracy, reliability or fitness for particular purpose of its content and the products and services presented therein. Specifications are subject to change without prior notice. Daikin Europe N.V. / Daikin Central Europe HandelsGmbH explicitly rejects any liability for any direct or indirect damage, in the broadest sense, arising from or related to the use and/or interpretation of this publication. All content is copyrighted by Daikin Europe N.V.  
 Catalogue 2019-2020 Chillers and air side equipment | Version April 2019  
 We reserve the right for printing errors and model changes

# 2019-2020 Childers Equipment

Product Catalog

2019-2020

Childers Equipment

Product Catalog

2019-2020

Childers Equipment

Product Catalog

2019-2020

Childers Equipment

Product Catalog

2019-2020

Childers Equipment